

# MindView Documentation

Introduction .....	1
Trademarks .....	1
MatchWare License Agreement .....	1
Welcome .....	5
Outlining written documents .....	5
Working with numbers .....	6
Working with task lists .....	6
Working with project plans .....	6
Working with timelines .....	7
Working on presentations and web sites .....	7
Using the ready-made templates .....	8
What's new in MindView 5 .....	9
Interface .....	9
Formatting .....	9
Presentation options .....	9
Outline view .....	10
Timeline view .....	10
Gantt charts .....	10
Calculation module .....	11
Import and Export options .....	11
Important terms .....	12
MindView Installation .....	15
Stand-alone installation .....	15
Administrative installation (system administrators only) .....	15
Troubleshooting .....	16
Support .....	17
Getting help .....	17
Online Help .....	17
The FAQ Knowledge Base .....	17
Service Packs .....	17
MatchWare Web Site .....	17
Reporting a problem .....	17
Quick Start .....	18
First step: Creating the mind map .....	18
Entering the subject .....	19
Inserting the main branches .....	19
Inserting the sub-branches .....	20
Saving the document .....	21
Second step: Enhancing the mind map .....	21
Choosing a style .....	21
Inserting pictures .....	21

Inserting icons.....	23
Inserting a text note .....	23
Inserting comments.....	24
Attaching a file .....	24
Creating a branch connection .....	25
Formatting the branches.....	25
User Guide .....	27
Setting up .....	27
Setting up your workspace .....	27
Setting up your preferences.....	32
Basic tasks .....	36
Creating a mind map.....	36
Saving a mind map .....	38
Opening a mind map.....	40
Entering a branch label.....	41
Inserting branches .....	41
Designing a mind map .....	45
Viewing a mind map.....	47
Zooming in and out .....	49
Inserting text notes.....	51
Inserting comments.....	56
Inserting icons.....	59
Inserting pictures.....	60
Inserting task data.....	65
Inserting timeline data.....	68
Inserting calculation values.....	72
Printing a mind map .....	79
Further tasks.....	82
Formatting a branch.....	82
Moving a branch .....	85
Focusing on a branch .....	87
Filtering a mind map .....	88
Attaching objects.....	89
Inserting sounds.....	91
Creating hyperlinks .....	92
Creating branch connections .....	94
Using sources .....	96
Using citations.....	101
Finding and replacing text.....	103
Inserting a new root .....	105
Detaching a branch.....	105
Setting a password .....	106
Tracking changes.....	106
Creating a legend.....	107
Presenting a mind map.....	108

Checking a mind map .....	109
Packing a mind map .....	110
Sending a mind map .....	111
Using the Multimedia Catalog .....	112
Using the Properties dialog .....	117
Using the Overview panel .....	118
Using the Object list .....	119
Collaborating .....	120
Accessing online workspaces .....	120
Managing online workspaces .....	120
Opening and saving online documents .....	120
Collaborating on an online document .....	122
Managing and tracking tasks .....	125
Views .....	127
Using different views .....	127
Mind Mapping views .....	128
Timeline view .....	131
Outline view .....	137
Gantt view .....	141
Spellchecking .....	181
Using the spellchecker .....	181
Spellchecking options .....	183
Exporting .....	187
Introduction .....	187
Additional folders .....	187
Exporting to Microsoft Word .....	188
Exporting to Microsoft PowerPoint .....	192
Exporting to Microsoft Excel .....	197
Exporting to Microsoft Outlook .....	201
Exporting to Microsoft Project .....	204
Exporting to HTML .....	205
Exporting to PDF .....	228
Exporting to Mediator .....	229
Exporting to RTF .....	245
Exporting to XML .....	248
Exporting as picture .....	249
Importing .....	251
Introduction .....	251
Importing from Microsoft Word .....	251
Importing from Microsoft PowerPoint .....	253
Importing from Microsoft Excel .....	257
Importing from Microsoft Outlook .....	259
Importing from Microsoft Project .....	261
Importing from Mediator .....	261
Importing from XML .....	263

Importing from other applications .....	264
Pen Mode .....	265
Working in Pen Mode.....	265
Reference.....	271
Properties .....	271
Overview .....	271
View .....	271
Root.....	273
Branch.....	275
Branch Data.....	277
Text note .....	277
Floating comment .....	278
Floating picture .....	279
Attachment.....	280
Hyperlink .....	280
Branch connection .....	281
Keyboard shortcuts .....	283
Index.....	285

# Introduction

## Trademarks

MatchWare, MatchWare Mediator, MatchWare MindView and MatchWare ScreenCorder are trademarks or registered trademarks of MatchWare A/S.

Mind Map and Mind Mapping are registered trademarks of the Buzan Organisation.

Microsoft, Microsoft Office, Microsoft Word, Microsoft PowerPoint, Microsoft Excel, Microsoft Project, Microsoft Outlook, Microsoft FrontPage, Microsoft Windows, Windows Media Player, Windows Explorer and Internet Explorer are trademarks or registered trademarks of Microsoft Corporation.

The 2007 Microsoft Office Fluent User Interface is subject to protection under U.S. and international intellectual property laws and is used by MatchWare A/S under license from Microsoft.

Netscape is a registered trademark of Netscape Communications.

Flash is a trademark of Adobe Systems Inc. (formerly Macromedia, Inc.).

WorldCat and the WorldCat logo are trademarks/service marks of OCLC Online Computer Library Center, Inc.

Other brand or product names are trademarks or registered trademarks of their respective holders.

This Product is copyrighted © 2002-2012 by MatchWare A/S. All rights reserved.

MatchWare and MatchWare MindView are trademarks or registered trademarks of MatchWare A/S. Other brand or product names are trademarks or registered trademarks of their respective holders.

Information given in this documentation can be changed and represents no obligation on MatchWare, its Publishers or Agents. This documentation is copyrighted © 2002-2012 by MatchWare A/S. All rights reserved. This documentation is not to be copied, photocopied, reproduced, translated or transferred to an electronic media or machine sensible form without a written authorization from MatchWare or its Publishers.

**IMPORTANT** You should read the following MatchWare License Agreement (EULA) carefully. If you install, copy, download, or use this software Product, you agree to be bound by the terms of this agreement. If you do not agree with the conditions, you are not entitled to install and use the software, and should immediately return the software package and all other material in this package along with proof of payment, to the authorized dealer from whom you obtained it for a full refund of the price you paid. Do not make any illegal copies.

## MatchWare License Agreement

### USE

This is a legal agreement between you, the end user, and MatchWare A/S ("MatchWare"). The enclosed software program ("Product") is licensed, not sold, to you by MatchWare for use under the term of this license.

Prior to using the license to the Product you must assign it to a device, which becomes the "licensed device". A hardware partition, blade, external hard drive, Flash drive etc. is considered to be a separate device.

You may install and use one copy of the Product on the licensed device. Further, the primary user of the licensed device may install and use another copy of the Product on a laptop.

This Product may be freely moved from one computer or location to another, so long as there is no possibility of it being used by more than one person at a time. You may make one (1) backup copy of the Product.

A Terminal Server is a computer allowing other Client computers to run applications on the Terminal Server such as but not limited to a Microsoft Terminal Server and a Citrix Server. If the Product is installed on a Terminal Server you need a license for each Client computer that can run the Product.

You may add users by paying for a separate license for each device you wish to add. When installing the Product on a server which allows multiple, concurrent users to access and run the Product, you must license (purchase) additional licenses for each computer.

When using Remote Desktop technologies you may access and use the Product provided that only the primary user of the device hosting the remote desktop session accesses and uses the Product with a remote access device. You are not permitted to use the Product on both the device hosting the remote desktop session and the access device at the same time.

You may not rent, lease, loan or license this Product or any copy.

You may not reverse-engineer, disassemble, decompile, modify or create derivative work of this Product.

### **ACTIVATION**

Mandatory activation is required when using the Product. When activating the Product certain information about the Product and the device will be sent to MatchWare. This information includes version, language, product ID of the Product, device internet protocol address and hardware configuration. By using the Product you consent to the transmission of this information.

### **EDUCATIONAL LICENSES**

Commercial use of Educational Licenses of this Product is prohibited.

You agree to not use an Educational License to engage in commercial activities including, without limitation, the following activities:

- offering for sale any products or services;
- soliciting for advertisers or sponsors;
- conducting raffles or contests that require any type of entry fee;
- displaying a sponsorship banner of any kind, including those that are generated by banner or link exchange services; and
- displaying banners for services that provide cash or cash-equivalent prizes to users in exchange for hyperlinks to their web sites.

Some educational multi-user licenses offer home use rights for teachers (and students). Any additional DVDs purchased to facilitate such home use may not be installed or used on the respective educational institution premises, buildings or campus.

If you are enrolled in the educational subscription program for the Product, the use of the Product is subject to the Subscription Agreement and this License Agreement.

### **TRANSFER OF THE PRODUCT**

You may transfer all of your rights to use the Product to another person, provided that you transfer to that person the entire Product package, DVDs, documentation, and this statement, and transfer or destroy all copies in any form. Once you transfer the Product you no longer have any rights to use it. Only the person to whom the Product is transferred may use it in accordance with the copyright law, international treaty and this statement.

If you have purchased an upgrade version of the Product, it constitutes a single product with the MatchWare Product that you upgraded. For instance, the upgrade and the Product that you upgraded cannot both be available for use by two different persons at the same time and cannot be transferred separately.

### **OEM VERSIONS OF THE PRODUCT**

An OEM version is a license of the Product that is distributed with a hardware device by the device manufacturer. An OEM version of the Product is identified as an OEM version either on the cover of the DVD (or CD) and/or in the main title bar within the Product.

You may transfer all of your rights to use the OEM version of the Product to another party only with the licensed hardware device, provided that you transfer to that person the entire Product package, DVDs, documentation, and this statement, and transfer or destroy all copies in any form. Once you

transfer the Product you no longer have any rights to use it. The OEM version of the Product may not be transferred separately without the hardware device.

### **COPYRIGHT**

All intellectual property rights in the Product and user documentation are owned by MatchWare A/S or its suppliers and are protected by United Kingdom copyright laws, other applicable copyright laws and international treaty provisions. MatchWare A/S retains all rights not expressly granted.

### **CLIPART**

This Product may contain clipart ("Clipart") such as images, sounds, video clips etc. All intellectual copyright for the Clipart is owned by MatchWare A/S or licensed by MatchWare A/S.

MatchWare grants you a non-exclusive, non-sublicensable right to use the Clipart in presentations or web sites created with this Product, including in runtime versions of the Product. There is no royalty due for such use to MatchWare. The Clipart may not be sublicensed or made available to any person or entity that does not have a legal license of this Product.

### **RUNTIME VERSIONS**

In some MatchWare products (including this Product) you have the opportunity to make runtime versions or web sites of your applications. Your runtime versions or web sites and the distribution of them are subject to all of the following conditions:

- You may not remove or alter any MatchWare copyright, trademark, or any other proprietary rights.
- You may not use MatchWare's or any of its suppliers' names, logos, or trademarks to market your runtime version. You may state that your runtime version was made using this MatchWare Product.
- You will remain solely responsible to anyone receiving your runtime versions or web site for support, service, upgrades, or technical assistance. The recipients will have no right to contact MatchWare for such services or assistance.
- You will indemnify and hold MatchWare, its related companies and its suppliers harmless from and against any claims or liabilities arising out of the distribution of your runtime versions.

### **LIMITED WARRANTY**

MatchWare warrants the physical media and physical documentation provided by MatchWare to be free of defects in materials and workmanship for a period of ninety (90) days from the original purchase date. MatchWare will replace defective media or user documentation at no charge, provided you return the item within the warranty period. If MatchWare is unable to replace defective media or user documentation, MatchWare will refund the amount you paid for the Product. These are your sole remedies for any breach of warranty.

### **LIMITATION OF LIABILITY**

The entire and exclusive liability and remedy for breach of the foregoing limited warranty shall be limited to replacement of defective media or documentation. In no event shall either party be liable to the other party for any special, indirect, consequential, exemplary, punitive, incidental, or similar damages, including but not limited to, loss of profit, data, or use of the Product, even if MatchWare has been advised of the possibility of such damages. MatchWare makes no representation or warranty that the Product or documentation are "error free" or meet any of the user's particular standards, requirements, or needs. In no event shall MatchWare's liability exceed the aggregate amounts paid by you pursuant to this Agreement. To the extent that applicable law does not allow the exclusion or limitation of implied warranties or limitation of liability for incidental or consequential damages the above limitation or exclusion may not apply to you.

### **INTELLECTUAL PROPERTY INDEMNITY**

MatchWare will, at its expense, indemnify, defend and hold Customer harmless against any and all action brought against you to the extent that it is based on a claim that the MatchWare Product or any part thereof or any MatchWare trademark used in relation thereto, when used within the scope of this Agreement, infringes any trademark, copyright, trade secret, patent or other intellectual property right, and MatchWare will pay any costs, damages and/or attorneys' fees awarded against you in such action or payable pursuant to a settlement agreed to by MatchWare. The foregoing obligation shall be subject to you notifying MatchWare promptly in writing of the claim, giving MatchWare the exclusive control of the defense and settlement thereof, and providing all reasonable assistance in connection therewith.

## **SUGGESTIONS**

MatchWare will have worldwide, irrevocable, royalty-free, perpetual license to use, develop and include in the Product any suggestions, recommendations or improvement requests or feedback from you, including users, to the Product.

## **CUSTOMER REFERENCE**

Either party may include the other party in a customer or vendor list. You also agree to consider the following upon request from MatchWare: (i) participate in case studies and in Return of Investment studies, (ii) serve as a reference, link exchange and use of your logo as reference on MatchWare's website, (iii) collaborate on press releases announcing the relationship.

## **U.S. GOVERNMENT RESTRICTED RIGHTS**

This Product and documentation are provided with RESTRICTED RIGHTS. The Product and documentation are developed at private expense and no part of them is in the public domain. Use, duplication, or disclosure by the Government is subject to restrictions as set forth in subparagraph c(1) and (2) of the Commercial Computer Software Restricted Rights clause at FAR 52.277-19 or subparagraph c(1) (ii) of the Rights in Technical Data and Computer Software clause at DFARS 252.227 - 7013. Manufacturer is MatchWare A/S, Vestergade 48F, 8000 Århus C, Denmark.

## **GENERAL**

This agreement is governed by English law and any dispute connected with this agreement and/or the Software is subject to the exclusive jurisdiction of the English courts. The export of this product is governed by U.S and UK export regulations.



## Welcome

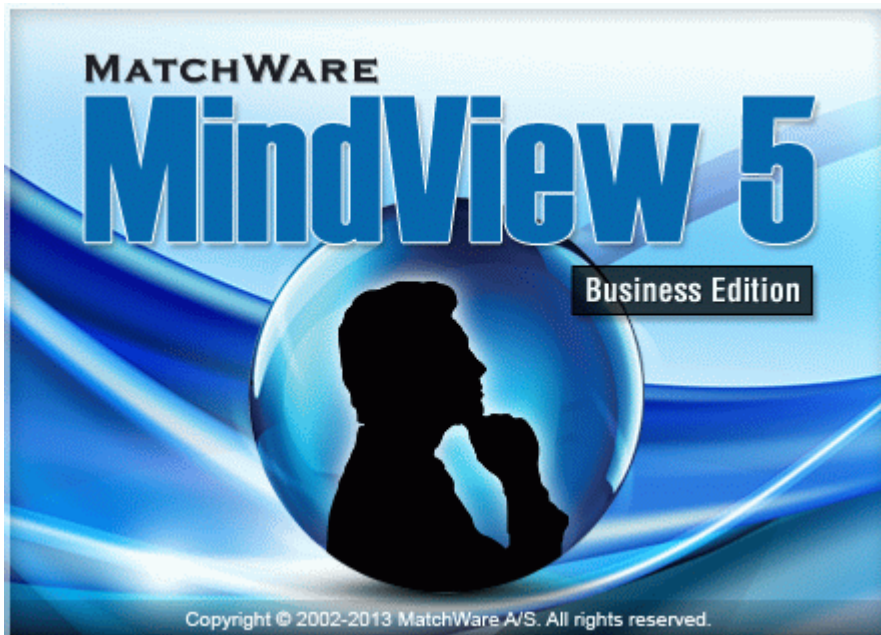

Welcome to **MatchWare® MindView™**, the perfect tool for businesses, educators and students who need to organize information! Easy to learn and easy to use, MindView is a highly effective way of **brainstorming, developing and structuring ideas visually**. Ideal for use by individuals, small teams or large groups, MindView generates illustrated **mind maps®** which you can use in presentations, reports, web sites and more. With a comprehensive range of export options to Microsoft® Office applications, MatchWare® Mediator, HTML and other formats, MindView is an effective and versatile concept development tool.

Mind maps are illustrated frameworks of organized, prioritized, linked ideas that develop or relate to a subject or concept.

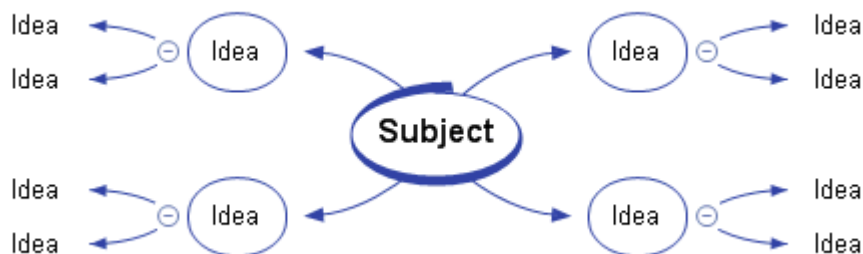

Mind maps have been demonstrated to help individuals and businesses achieve higher levels of performance by increasing productivity and organization skills.

### Outlining written documents

Using the Mind Mapping technique makes it very easy to outline your written documents such as meeting agendas, proposals and marketing plans. MindView allows you to brainstorm ideas for your main topics in a completely free and non-linear way. One of the great benefits of using MindView, as opposed to brainstorming on a piece of paper, is that MindView allows you to reorganize your ideas in the right order by dragging and dropping them in the mind map once you have finished listing them.

When you export your mind map to **Microsoft® Word**, you can choose from a variety of creative templates designed to give your document a professional look instantly. Main ideas are exported as main headings, sub-ideas are exported as sub-headings and so on. All the text notes, comments, pictures and other elements which you have placed on the mind map are also exported. This means that you can actually start writing your report while brainstorming in MindView, as the complete text is included in the exported Word document.

Once you start developing your document in Word, you may realize that you have forgotten some key ideas that you would like to brainstorm in MindView first. All you need to do in that case is to import your Word document back into MindView, add the new ideas to your mind map, and then re-export to Word.

### Working with numbers

The **Calculation** module of MindView Business Edition allows you to add values to the branches of your mind map, for example sales numbers, costs, exchange rates and so on, as well as formulas to carry out calculations on the values. Built-in functions allow you to display values automatically rolled up from lower sub-branches to higher ones.

If for instance you have created a mind map to track worldwide sales, you can then export it as an **Microsoft® Excel** spreadsheet in order to continue working directly in Excel.

Conversely, you can also import an Excel spreadsheet in MindView. Values and formulas (provided they are supported by MindView) will be preserved in the mind map created by this process.

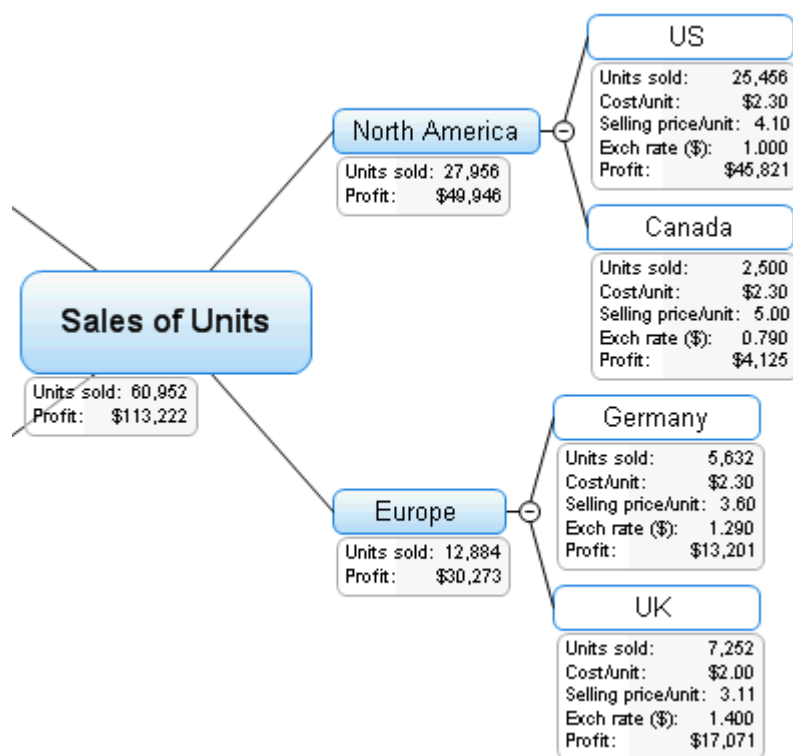

### Working with task lists

Use Mind Mapping to brainstorm, visualize and organize your tasks. Then convert your mind map into a detailed implementation plan by adding task information such as dates, resources, priorities and completion percentages.

Task lists can be created in an instant and displayed in the Outline view or exported to **Microsoft® Outlook**. You can also import task lists from Outlook and synchronize information between MindView and Outlook to eliminate redundancies.

### Working with project plans

The MindView Gantt view, specific to the Business Edition, is a specialized view, dedicated to the creation, editing and management of project plans according to the rules of project management.

MindView lets you build, view and manage complex project plans in the Gantt view. Setup deadlines, milestones and dependencies while keeping an eye on the critical path to ensure your team delivers on time every time.

If necessary, you can easily export your project plan to **Microsoft® Project** to take advantage of its advanced project management capabilities. You can also import existing project plans directly from Microsoft Project or via the Microsoft Project XML format if you prefer to use the easy-to-understand, visual MindView interface.

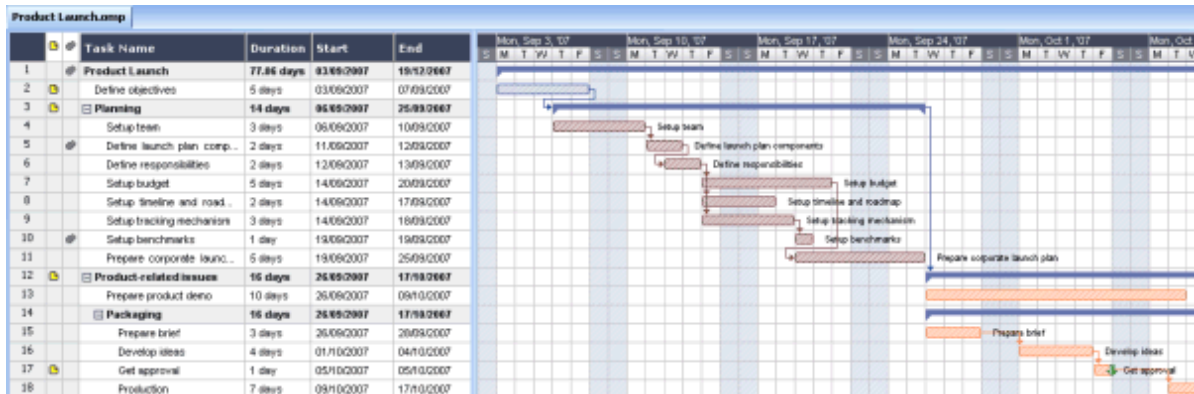

## Working with timelines

The MindView Timeline view is a great way of displaying time-related information such as company history, marketing plans, production plans and historical data. Simply add dates or times to your branches and switch to the Timeline view to see the information displayed along a horizontal time axis. Different timescales (for example standard, weekly or daily) let you tailor the timeline to suit your needs. You can zoom in or out, expand or contract the timeline scale, and condense empty stretches of the timeline by inserting break marks.

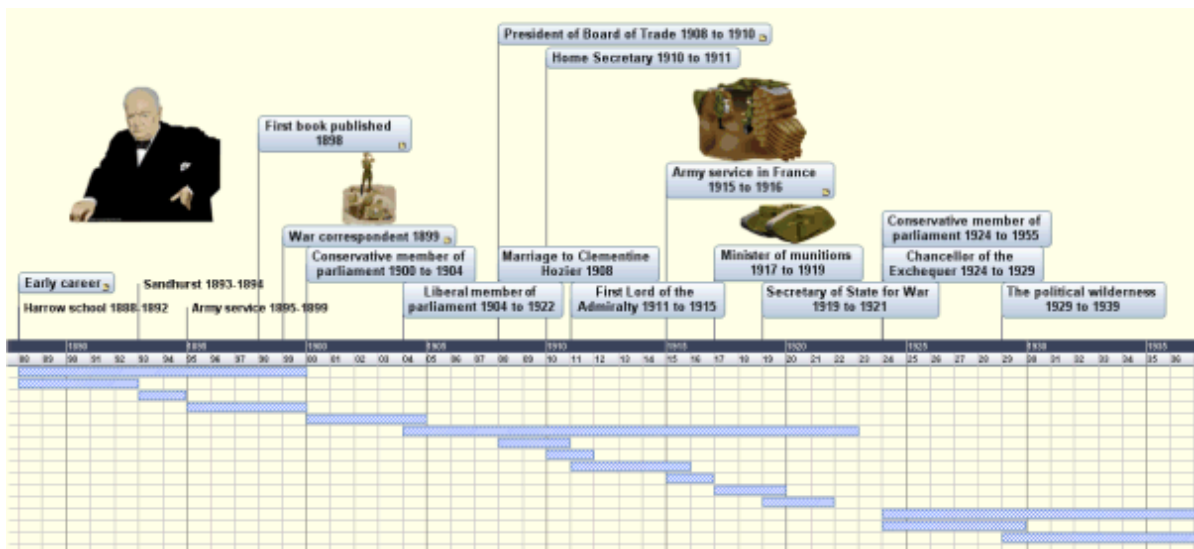

## Working on presentations and web sites

MindView has been optimized for storyboarding and planning web sites and multimedia presentations, which you can then export to **Microsoft® PowerPoint**, **MatchWare® Mediator** or **HTML**:

- When storyboarding presentations, an idea in your mind map represents a slide (PowerPoint) or a page (Mediator) in your presentation, a sub-idea represents a sub-page or sub-slide and so on.
- You can attach files to branches (ideas) in the mind map, such as Flash files, pictures, text, sounds and videos. These files are included when you export to PowerPoint, Mediator or HTML and displayed on their respective pages.
- MindView lets you create hyperlinks, branch connections and other interactivity that is also included when exporting.

- The Export Wizards include a range of ready-made templates with built-in navigation, which you are free to customize and save for further use.
- MindView allows basic web editing during the HTML export. You can for instance place the various elements where required on each individual page. No coding or scripting necessary!
- Once exported, you can import your Mediator or PowerPoint presentation back into MindView if you need to storyboard more pages or slides.

### Using the ready-made templates

MindView provides you with detailed business templates for use in the standard Mind Mapping views, as well as ready-made project plans specific to the Gantt view, covering a range of common business activities.

You can base your own documents on any of these templates, and customize them as required to meet your particular needs. Comments and suggestions for expansion are given in their notes and pop-up comments.

## What's new in MindView 5



MindView 5 has many new features, which are fully described in this documentation. Here is a brief description of the most important enhancements.

### Interface

**Microsoft Office 2013 interface:** MindView has been updated with the new Office 2013 interface. For more information about the MindView interface, see "[Setting up your workspace](#)".

**Transitions:** Screen transitions when zooming in and out, or navigating to different areas of the mind map, have been made smoother. For more information, see "[Setting up your preferences](#)".

**High Contrast mode:** MindView 5 supports the standard High Contrast mode included in Windows and includes new map styles designed specifically to work in that mode.

### Formatting

**Templates:** MindView 5 includes new customized templates for project management and study skills, on which to base your own projects. For more information about templates, see "[Creating a mind map](#)".

**Styles:** MindView 5 includes new map styles that have been optimized for specific project types, letting you change the overall look of the map and apply branch shapes, branch colors and other coordinated attributes in one step. Simply hover over the contents of the Styles gallery to visualize the effect of the different options on your map, then click your choice to apply it.

MindView 5 also lets you define your own customized styles. Just choose the ready-made style that is the closest to the effect you want to achieve, make your own changes, and save the style as a custom style for re-use later. To find out more about the Custom Style Designer, see "[Designing a mind map](#)".

**Branch pictures:** MindView 5 allows you to paste pictures directly on branches. This means you can now use popular screen clipping tools like the Windows Snipping tool to add graphics to the branches of your mind map. For more information, see "[Inserting pictures](#)".

**Numbering scheme:** When you use a numbering scheme to number the branches of your mind map sequentially, you can now choose whether the numbering should start from the root, or from the first main branch. For more information, see "[Viewing a mind map](#)".

**Document statistics:** To help you overview the amount of data you have included in your mind map, MindView 5 lets you view document statistics such as word count, branch count and so on. For more information, see "[Viewing a mind map](#)".

### Presentation options

**Map Navigation:** The Map Navigation feature allows you to set pins (bookmarks) on your branches, in order to locate them quickly again in your map. When you select a pinned branch in the Map Navigation menu, the branch is automatically selected and the map becomes centered on that branch. For more information, see "[Viewing a mind map](#)".

**Legend:** MindView 5 now lets you add legends to your maps, to make them easier to read and interpret. You can for instance associate a particular color or a particular icon to some of the branches of your map to single them out, and then apply a legend to give the meaning of this color or icon. For more information, see "[Creating a legend](#)".

**Text to Speech:** MindView 5 now supports a narrating function. Just select a branch label, a text note or a comment and click the Narrate button to have that element read aloud. For more information, see "[Viewing a mind map](#)".

**Printing:** The printing options and print preview feature have been enhanced and integrated to the ribbon, making it much easier to use. For more information, see "[Printing a mind map](#)".

## Outline view

The Outline view now has its own Tools tab, regrouping the most commonly used functions. You can use it for instance to indent, outdent, move up or move down the branches in the outline to rearrange the corresponding topics, number them, or choose the columns to be displayed. It is now also possible to show the text notes associated with the branches in the outline itself, just underneath each branch. Finally you can choose between different text sizes for the outline. For more details, see "[Using the Outline view](#)".

## Timeline view

The Timeline view now also has its own Tools tab, allowing you to design your timeline and optimize its display without having to navigate between different ribbon tabs to find the commands you need. For more information, see "[Using the Timeline view](#)".

## Gantt charts

**Gantt Tools tab:** This tab now includes a Go to Today's Date icon that lets you view the project plan from the current date onwards. For more information about the Gantt Tools tab, see "[Using the Gantt view](#)".

**Resource cost:** When defining the list of the resources to be assigned to your project, you can now associate a unit cost (per hour, day, week etc.) to each resource, letting you track the overall cost of the project. For more information, see "[Assigning resources](#)".

**Material resources:** In addition to human resources, MindView 5 supports material resources, i.e. the consumable items (paper, electricity, sand etc.) that you need to carry out the project. You can also associate a unit cost to material resources, so that you can track the overall cost of your project in human as well as in material resources. For more information, see "[Assigning resources](#)".

**Work units:** When assigning a person to a task, MindView 5 lets you specify how much of their available time is being used to work on the task. By default, people assigned to a task are assumed to be able to devote 100% of their working time on the task. If a person is only available part of the time, for instance because they also have other duties, you can specify the percentage of their working time that they can spend on the task. Together with the resource unit cost and the task duration, the work units value lets you determine the cost of each of your resources and the cost of your overall project. For more information, see "[Assigning resources](#)".

**Work and Cost information:** When viewing a Gantt project in one of the Mind Map views, you can now display the work information on each of its branches: overall work value for the task, actual work value to date, and remaining work value. You can also display the corresponding cost values, i.e. overall cost of the task, actual cost to date, and remaining cost. MindView's calculation module also lets you perform calculations on all these values, and includes some new functions for this purpose. For more information, see "[Inserting calculation values](#)".

**Resource calendars:** MindView 5 supports resource calendars, letting you define the working and non-working time of each of your resources. Together with the project calendar, the resource calendars determine when work on the different tasks can be allowed to happen. For more information on this topic, see "[Assigning resources](#)".

**Effort-driven scheduling:** By default, allocating additional resources to a task in MindView 5 increases the work value of the task, but has no effect on its duration. You may however expect that adding another full-time resource to a task should reduce its duration by half. This scheduling method is known as "effort-driven scheduling". By default, MindView does not apply effort-driven scheduling, but you can choose to activate this scheduling method on your tasks. For more information, see "[Assigning resources](#)".

**Task types:** By default, all the tasks you create in a Gantt project are given the task type "Fixed Units". This means that the percentage of availability of the resources (units) you defined when you assigned these resources to a task always remains the same, regardless of any changes you might make to the duration or work value of the task. MindView 5 however supports two other task types, namely "Fixed Work" and "Fixed Duration", letting you achieve different results when you vary one of the parameters in the "duration, work and units" equation. For more information, see "[Using scheduling task types](#)".



**Inactive tasks:** If you want to keep a task in your project plan, but prevent it from affecting its scheduling, you can now make it inactive. This can be useful if you are forced to remove some tasks from your project for budget or deadline reasons, but want to keep a record of them. For more information, see "[Enhancing a project plan](#)".

**Gantt reports:** The resources reports have been updated to take into account the new features of MindView 5, such as resource calendars, resource costs and work units. The new "Resource Cost" report show the overall cost of each resource working on the project, as well as the total cost for all the resources. For more information, see "[Creating project reports](#)".

## Calculation module

**Functions: As mentioned above,** MindView 5 features new functions that let you perform calculations on the cost and work values of your Gantt projects. See "[Inserting calculation values](#)" for more information.

**Constants:** As well as variables, the calculation module now lets you define constant values. Constant values are not displayed on the branches of the mind map, but can be used in calculations using formulas. See "[Inserting calculation values](#)" for more information.

## Import and Export options

**Microsoft Word export:** Microsoft Office files that have been added to the mind map as attachments are now automatically embedded in the .docx file produced by the export. For more information, see "[Exporting to Microsoft Word](#)".

When exporting your document to Microsoft Word, you can also choose from a variety of bibliography styles, such as APA, MLA, Chicago and more, to reference your sources and citations. For more information about adding sources and citations in your documents, see "[Using sources](#)" and "[Using citations](#)".

**Microsoft Outlook import/export:** The synchronization feature, allowing you to align a MindView task list with its Outlook version and vice-versa, has been made easier to use in MindView 5. See "[Exporting to Microsoft Outlook](#)" and "[Importing from Microsoft Outlook](#)".

**Microsoft Project export/import:** All the new scheduling data supported by MindView 5 (see "Gantt charts" above) can now be exported and imported from Microsoft Project. For more information, see "[Exporting to Microsoft Project](#)" and "[Importing from Microsoft Project](#)".

## Important terms

Many of the terms used in MindView belong to the standard Windows terminology. Some terms, however, are specific to MindView or related to the Mind Map concept and may be unfamiliar to you.

### Attachments and hyperlinks

MindView allows you to attach various objects to the root or branches of your mind map, such as text documents, pictures, videos, sounds, Flash™ files or URL links, which you can activate from within the mind map. These objects are listed in the MindView Object list, and can all be exported when exporting your map to a different format. See "[Attaching objects](#)" and "[Creating hyperlinks](#)" for more information.

### Branch connections

A branch connection is used to indicate visually that two branches are conceptually related. This relationship is identified on a map by an arrow-headed line joining the source branch to the end branch. See "[Creating branch connections](#)" for more information.

### Calculation values

MindView allows you to add values to the branches of your mind map, for example sales numbers, costs, exchange rates and so on, as well as formulas to carry out calculations on the values. You enter values using the Calculation panel, accessed from a tab on the right of the workspace.

For more information, see "[Inserting calculation values](#)".

### Comments

Comments are short notes that you can add to the root of your map, to a branch or to the workspace itself. See "[Inserting comments](#)" for more information.

### Document

Each MindView document you create opens in a separate tab bearing the name of the document. A MindView document can contain several maps. You can also keep several documents open at the same time in MindView. MindView documents are saved with the extension .mvdX. See "[Creating a mind map](#)" for more information.

### Export

Once you have finished the design of your document, you can export it to other formats, such as a Microsoft® PowerPoint presentation, a Microsoft® Word or .RTF document, a Microsoft® Excel spreadsheet, a Microsoft® Project document, a Microsoft® Outlook task list, a MatchWare Mediator document or a picture. You can also export to HTML and XML.

See the section "[Exporting](#)" for more information.

### Gantt view

The MindView Gantt view, specific to the Business Edition, is dedicated to the creation, editing and management of project plans according to the rules of project management. The Gantt view is made of two parts, an Outline on the left which represents the project plan as a hierarchical list of tasks, and a Gantt chart on the right, which shows the tasks as horizontal bars arranged against a background calendar display.

See "[Using the Gantt view](#)" for more information about project plans and project management. See also the definition of a project plan in this topic.

### Import

Not only can you export your document to PowerPoint, Word, Excel, Outlook, Microsoft Project or Mediator, but you can re-import the exported document into MindView as a new document, while preserving much of the additional work you might have done on the document in these external applications. You can also import into MindView documents originally created in PowerPoint, Word, Excel, Microsoft Project or Mediator as well as task lists from Outlook and XML documents.

See the section "[Importing](#)" for more information.



## Icons

MindView lets you place icons on the branches of your mind map to attract attention or illustrate a particular idea. Using icons, you can for instance represent visually the status of a particular topic, its importance, and so on. See "[Inserting icons](#)" for more information.

## Left/Right view

This view represents your mind map as a list of topics placed either on the right of the root (Right view) or on the left of the root (Left view). It is a good choice when you need to present data in a list form and want to be able to fully explore each point in the list before going on to the next point. See "[Using different views](#)" for more information.

## Main branch

The main branches are the branches that are directly connected to the root. They represent the main topics related to the subject of your mind map. See "[Inserting branches](#)" for more information.

## Mind Map

A mind map is made up of its root, all its branches and sub-branches and all inserted elements (icons, comments, text notes and so on) and attached objects (text files, picture files, video files, hyperlinks and so on). Note that MindView allows you to create several different maps in the same document.

## Mind Map view

This is the default view when creating a new mind map. It represents the map with the root in the center, and all the main branches radiating from it in a clockwise direction. This is a good view to use when brainstorming ideas for a mind map without worrying about evaluating or structuring them. See "[Using different views](#)" for more information.

## Outline view

The Outline view represents the map as a hierarchical list which you can expand and collapse as required. It allows easy navigation through the document from top to bottom and gives you another way to brainstorm ideas. For detailed information about working in the Outline view, see "[Using the Outline view](#)".

## Pack & Unpack

This feature allows you to distribute your mind map to other users very easily. With a few mouse clicks, you can create a packed map containing all the pictures and files you may have attached to it, ready to be accessed over the network or distributed by email. See "[Packing a mind map](#)" for more information.

## Pre-branch

A pre-branch is a branch that you insert before the currently selected branch. See "[Inserting branches](#)" for more information.

## Project plan

A project plan is a series of interdependent tasks that need to be performed in a particular order. A project plan has a specific start date, corresponding to the start of the first task, and a specific end date, corresponding to the end of the last task and the completion of the project. If one task runs late, all the tasks that are dependent on the delayed task are affected and their dates are automatically recalculated. MindView lets you build, view and manage complex project plans in the Gantt view. See "[Using the Gantt view](#)" for more information about project plans and project management.

MindView also supports the creation of task lists, which are much simpler than project plans. See the definition of a task list in this topic.

## Root

The root is the central block that appears when you create a new mind map. It represents the subject of the map. Any branch that you attach directly to the root is a main branch. See "[Inserting branches](#)" for more information.

## Sub-branch

Any branch belonging to a main branch is called a sub-branch. Each sub-branch can have its own sub-branches. Sub-branches represent various levels of sub-topics. See "[Inserting branches](#)" for more information.

### **Task list**

A task list is a series of individual tasks which are not connected to each other. If one task is delayed, this has no effect on any of the other tasks. MindView lets you add task information such as dates, priorities and resources to the branches of your document in order to create simple task lists. See "[Inserting task data](#)" for more details.

MindView also lets you build and manage project plans, which are more complex than task lists. See the definition of a project plan in this topic.

### **Templates**

MindView comes with a large number of educational, business and personal templates on which you can base your own mind maps. You can also save your own mind maps as templates for future use. See "[Saving a mind map](#)" for more information. Templates are saved with the extension .mvtx.

### **Text notes**

Text notes, unlike comments, are comprehensive notes that you can enter using the Text Note editor and associate with the root or any branch of your map. See "[Inserting text notes](#)" for more information.

### **Timeline view**

The Timeline view lets you see all the branches of your mind map that contain time information displayed in chronological order along a horizontal time axis. Different timescales (for example standard, geological and historic) let you tailor the timeline to suit your needs. For more information on the Timeline, see "[Using the Timeline view](#)".

### **Top Down view**

This view represents your mind map as a hierarchical pyramid, with the root at the top, the main branches underneath, the sub-branches below the main branches and so on. It is a useful representation for structured data which needs to be viewed in a hierarchical manner, in other words from the higher level to the lowest levels. See "[Using different views](#)" for more information.

# MindView Installation

## Stand-alone installation

- Insert the DVD in the drive.
- Follow the instructions on the screen when the MindView Install program starts.

If the MindView Install program does not start automatically:

- Choose **Start - Run**.
- Type the following:

```
X:\start.exe
```

where X represents the DVD drive letter.

## Administrative installation (system administrators only)

The Windows® Installer can perform an administrative installation of an application or product to a network for use by a workgroup. An administrative installation installs a source image of the application onto the network that is similar to a source image on a DVD. The administrative installation package can then be pushed by system administrators to client computers in a domain via Group Policies. This is only possible from Windows 2000 Server onwards.

To find out more about Windows® Installer and administrative installations, please refer to the Microsoft web site.

## Creating an administrative installation

Administrators can create an administrative installation from the command line by using the /a command line option.

- Choose **Start - Run**.
- Type the following:  

```
msiexec.exe /a X:\install\setup.msi
```

where X represents the DVD drive letter.  
(please check the location of the setup.msi on the DVD)
- Specify the following in the dialog that appears:
  - Where you want to unpack the .msi file
  - The user name and company name to use as default
  - The serial number
- (optional) Check 'Force activation when MindView is run' if you want MindView to be automatically activated the first time the program runs.
- (optional) Check 'Automatically activate during installation' if you want to activate MindView during installation.



These two activation options are "silent" (i.e. they do not display any messages).



*The above options are stored in a file called "admin.ini" in the destination folder. You can edit this file using a text editor like Notepad if you want to change the options without making a new administrative installation.*

## Applying a patch package to an administrative installation

- Choose **Start - Run**.
- Type:  

```
msiexec.exe /p <path to .msp file> /a <path to administrative .msi file>
```

Members of the workgroup using MindView must then reinstall the application from the new administrative source image to receive the update.

To completely reinstall the application and cache the updated .msi file on their computer, users may enter either of the following commands:

- `msiexec.exe /fvomus //server/<administrative .msi file>`
- `msiexec.exe /I //server//<administrative .msi file> REINSTALL=ALL REINSTALLMODE=vomus`

## Troubleshooting

### Changing the location of the activation file

By default, the activation data is stored in:

```
C:\Documents and Settings\All Users\Application  
Data\mwas\MindView5.0.mwas
```

(Windows 2000 and Windows XP), or

```
C:\ProgramData\mwas\MindView5.0.mwas
```

(Windows 7 and Vista)

In some rare situations, client computers may be setup with restricted access to the above folder, and this will cause the activation file not to be saved. If you have a client server system setup in this way, you can move the activation file to another location by adding an entry to the admin.ini file as follows:

```
[Activation]  
mwas=c:\different folder with write access\MindView5.0.mwas
```

### Storing several activation files on the server

You can store several activation files in the same folder of the server by adding an entry to the admin.ini file as follows:

```
[Activation]  
mwas=\\server\activations\MindView5.0_%COMPUTERNAME%.mwas
```

Where:

server = the name of the server

activations = the share name on the server

%COMPUTERNAME% will be replaced with the client computer name

### Problem applying a patch

Q. Nothing happens when I double-click the patch file (ex. patch.msp).

A. The .msp file extension may be allocated to an application other than the Windows installer.

In this case, you can apply the patch as follows:

➤ Chose **Start - Run**.

➤ Type the following command:

```
msiexec.exe /p c:\temp\patch.msp
```

(assuming that you have copied the .msp file to c:\temp)



# Support

## Getting help

The MindView documentation is provided as online help in the program.

### Online Help

You can access the online help system by pressing **F1** or by clicking the small question mark  on the top right of the MindView window.

To obtain help on a particular dialog, click the small question mark   on the top right of the dialog in question.

### The FAQ Knowledge Base

For additional information, please refer to our FAQ Knowledge Base:

<http://faq.matchware.com/en/>

As well as answering the most commonly asked technical questions concerning the MatchWare products, this database allows you to post comments and send questions to MatchWare.

### Service Packs

If you encounter a problem that you are not able to solve by referring to the FAQ, check that you have installed the latest MindView service pack available. MatchWare releases service packs regularly to provide enhancements and correct errors reported by its users.

You can find service packs for MatchWare products at:

<http://www.matchware.com/en/support/default.htm>

### MatchWare Web Site

The MatchWare web site contains extensive information on all the products offered, as well as tutorials, templates and reviews. Updates are posted regularly. To see what is currently available, please visit:

<http://www.matchware.com/en>

## Reporting a problem

To report a problem, bug or any other error in MindView, please send a message to MatchWare via our FAQ Knowledge Base:

<http://faq.matchware.com/en/>

MatchWare is registered with the Windows® Quality Online Services. In the unfortunate event of an application failure, the Windows Error Reporting system will capture relevant product data and enable you to forward this data to MatchWare automatically.

# Quick Start

This Quick Start takes you through all the basic steps required to build a mind map from scratch and enhance it with design effects, icons, comments, pictures, attachments and so on.

The map we are going to create here is about planning a weekly meeting.



The complete mind map, "Weekly Meeting.mvdx", can be found in the MindView program folder, in "...\MatchWare\MindView 5.0\QuickStart".

## First step: Creating the mind map

In this first step of our Quick Start example, we are going to create all the branches we require for our meeting agenda.

We start by creating a new MindView document.

- Start MindView and choose **New Document** in the Welcome dialog.



*If you have closed the Welcome dialog, you can create a new document by pressing **Ctrl + N**.*  
The New Document dialog opens.



In this Quick Start, we will use the Mind Map view, which is the default view in MindView.

- Select the **Mind Map** thumbnail and click **Open**.

Your new map appears with the root block ready for you to fill in.



### Entering the subject

- Type "Weekly Meeting" and press **Enter**.



The default file name "Weekly Meeting" is now shown on the document tab.



The asterisk to the right of the name indicates that the document contains data which has not yet been saved.

### Inserting the main branches



We are now going to insert a few branches, corresponding to various topics we would like to include in our agenda, namely:

- A section for the opening remarks
- A section on budget issues
- A section on the upcoming office relocations
- A section for the closing remarks

Let's start by inserting the first branch.

- Press **Enter**.

The first branch is now visible. Its default label is "Idea".

- Type "Opening remarks" and press **Enter**.
- Press **Enter** again to insert the second branch.
- Type "Budget" and press **Enter**.
- Insert two more branches by pressing **Enter** and label them "Relocations" and "Closing remarks".

As you can see, branches are inserted in a clockwise direction around the root.

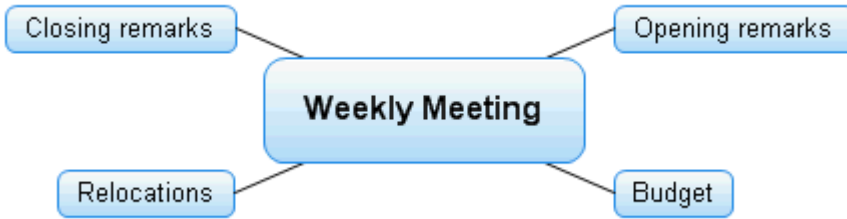

## Inserting the sub-branches



We now want to insert some sub-branches, corresponding to the sub-topics of our main topics.

- To add the first sub-branch to the Opening remarks topic, click the corresponding branch to select it and press **Insert**.
- Type "Welcome" and press **Enter**.
- Press **Enter** again to add the second sub-branch.
- Type "Objectives" and press **Enter**.
- Type "Previous minutes" and press **Enter**.
- Now select the "Budget" branch and press **Insert** to add its first sub-branch.
- Continue in the same way until you have added all the other sub-branches shown below.

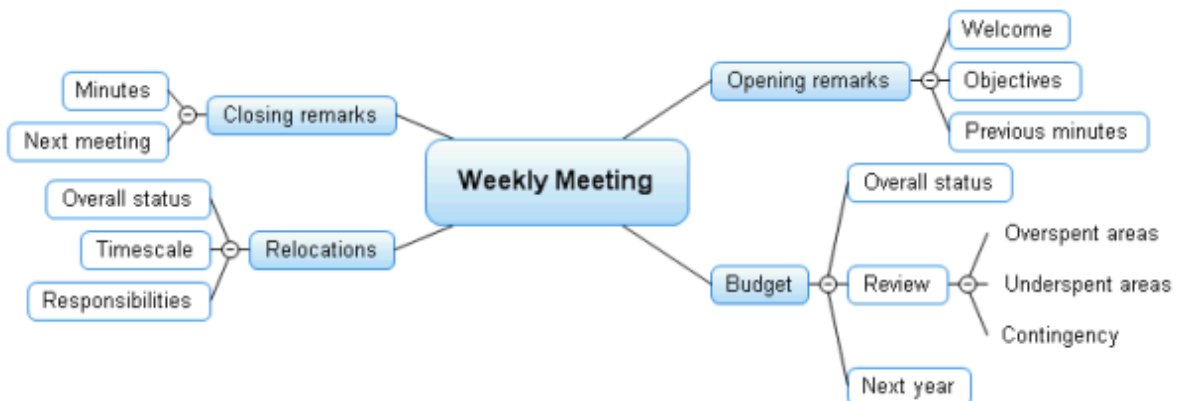

To correct typing errors, select the relevant branch and click the label. Then place the cursor at the required position, press **Delete** or **Backspace** to remove the incorrect characters, type the correct ones and press **Enter**.



## Saving the document

Let us save the work we have done so far before going on to the second step.

- Click the **Save Document** icon  in the Quick Access Toolbar or press **Ctrl + S**.
- In the Save As dialog that opens, choose a folder, enter a file name for your new mind map and click **Save**.

The default file name, derived from the subject of the map, is "Weekly Meeting.mvdx".

## Second step: Enhancing the mind map

In this second step of our Quick Start example, we are going to enhance our meeting agenda by adding a variety of visual elements and multimedia objects to it.

### Choosing a style

MindView contains galleries of predefined layouts and styles, which allow you to apply branch shapes, branch colors and other coordinated attributes in one step.

- Click the **Design** tab in the main menu.

This tab contains all the design options applicable to the current view, in this case the Mind Map view.

- Browse through the **Layouts** gallery to choose your preferred layout.

As you browse through the options, MindView shows you an immediate preview of their effect on the map. To apply a particular option, just click it. As we are designing a standard mind map, we are going to keep the default layout.

- Browse through the **Styles** gallery to choose your preferred style.
- (optional) To further customize the visual aspect of your map, explore the options available in the **Effects** and **Properties** panels.

All the design options you choose here apply to the entire map. You can come back to this Design tab at any stage to change or add design options to your map. You might even prefer to leave the design phase to the end, once you have put in place all the contents of your map.

As well as specifying global design options, MindView lets you apply different design effects to individual branches of the map, as we will see at the end of this Quick Start.

### Inserting pictures



It is considered good Mind Mapping practice to insert a picture in the root block to illustrate the theme of the map, so we are going to do just that:

- Click the **View** tab in the main menu.
- Click **Show/Hide | Multimedia Catalog**.

The Multimedia Catalog opens.

- Click the **Search for** field of the Multimedia Catalog and type "meeting".  
Various pictures appear in the Multimedia Catalog display area.

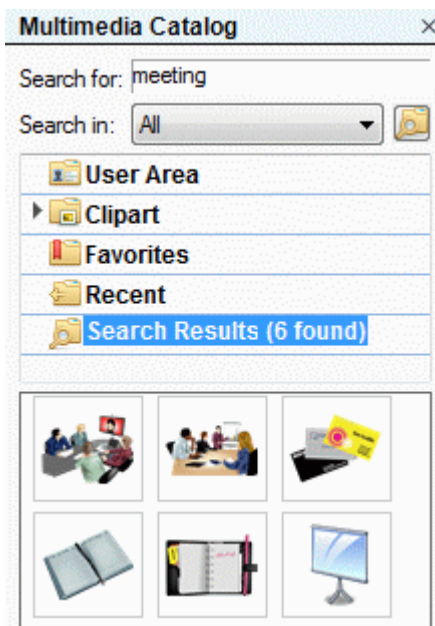

- Drag the picture of the meeting over the root block and let go of the mouse button. The root block now contains a picture of a meeting. This type of picture, which "sits" on the branch to which it belongs, is called a "branch picture".



We also have a picture of a removal truck which we are going to insert as a "floating picture" to illustrate the Relocations branch.

- Click the Relocations branch to select it.
- Click the **Insert** tab in the main menu.
- Choose **Pictures | Floating Picture**.
- Browse to "...\MatchWare\MindView 5.0\QuickStart" in the Program Files folder, select the file "Truck.png" and click Open.

A picture of a truck now appears on the map. You can move this picture wherever convenient by dragging it with the mouse. Note that a thin line connects it to the branch to which it belongs.

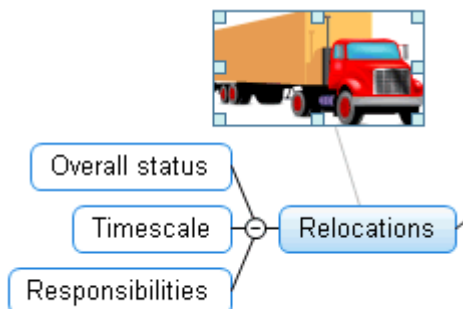

## Inserting icons



Inserting icons on the map is a useful way of attracting attention or illustrating a particular idea.

- Select the Budget branch.
- Click the **Insert** tab in the main menu.
- Click the small arrow under the **Icons** icon at the far right.
- Click the dollar sign icon in the Standard icon palette.



The icon now appears next to the branch label name.

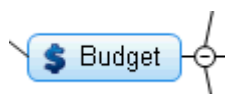

- Select the Relocations branch and add the red flag icon to it to indicate that the deadline for the office move is approaching.

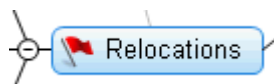

## Inserting a text note



The MindView Text Note editor lets you add comprehensive text notes to any branch of your map.

We want to add a note to the Closing remarks branch to explain why we might want to broaden the list of attendees for the next meeting.

- If it is not already visible, open the Text Note editor by choosing **View | Show/Hide | Text Note Editor**.
- Select the Closing remarks branch and type the following text (or any other) in the Text Note editor.

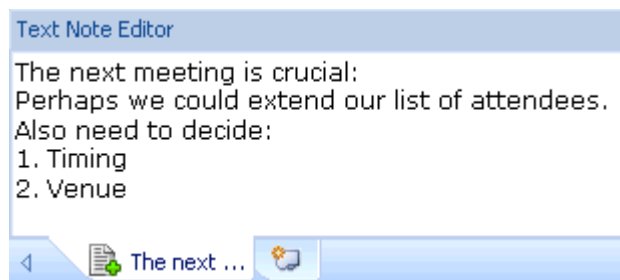

As soon as you click the Text Note editor window, an **Edit** tab appears at the right of the ribbon to help you format your note.

- Format the text to your liking and click outside the Text Note editor.

A paperclip icon  now appears to the right of the Closing remarks branch label, indicating that this branch contains an object.



## Inserting comments



We would also like to insert a couple of shorter comments and reminders in our map.

We start by adding a "floating comment" to the Relocations branch to indicate that the planning deadline is approaching. Floating comments stay visible on the screen at all times.

- Click the Relocations branch to select it.
- Choose **Insert | Text | Floating Comment** in the main menu.  
A floating comment box opens with the default text "Insert Floating Comment".
- Enter the text of the floating comment as shown below and press Enter.
- (optional) Move the floating comment by dragging it wherever convenient.



We are now going to insert a "pop-up" comment in our Opening remarks branch as a reminder to welcome new staff. Pop-up comments are normally hidden.

- Select the Opening remarks branch. This time, rather than using the main menu, press **F11** (MindView's more commonly used commands have function key equivalents).  
A yellow comment box opens.
- Enter the text of the comment as shown below and click outside the yellow box.

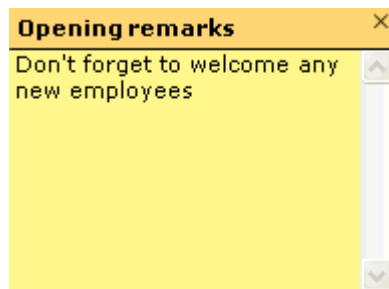

The comment box disappears, but a yellow comment icon  now appears next to the branch label, indicating that this branch contains a pop-up comment. You can view the comment at any time by moving the mouse pointer over the icon, and edit it by clicking the icon.

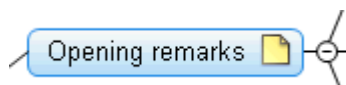

## Attaching a file



Since we have developed a spreadsheet to help us plan next year's budget, we are going to include it as a file attachment on our map.

- Click the Budget branch to select it.
- Choose **Insert | Links | Attachment** in the main menu.
- Browse to "...\MatchWare\MindView 5.0\QuickStart", select "Budget.xls" and click OK.

A paperclip icon  now appears to the right of the Budget branch label, indicating that this branch contains attached objects.

- To view the attachment, move the pointer over the paperclip icon.  
The object pop-up list appears.

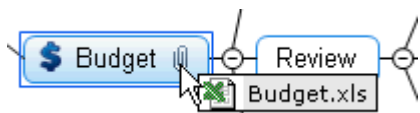

Assuming Microsoft® Excel is installed on your computer, all you have to do to view the spreadsheet is to click the attachment in this list.

The attachment is also listed in the Object list for the branch.

- To view the Object list, choose **View | Show/Hide | Object List** in the main menu.

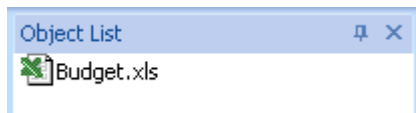

## Creating a branch connection

Since we want to consider this year's underspent areas when planning next year's budget, we want to create a visual link between the two topics on the map.

- Choose **Insert | Links | Branch Connection** in the main menu.  
The mouse pointer changes shape.
- Move the mouse pointer to the Underspent areas branch, click it, drag the pointer to the Next year branch until it gets highlighted and let go of the mouse button.  
A line now joins the Underspent areas branch to the Next year branch, indicating that the two branches are related.

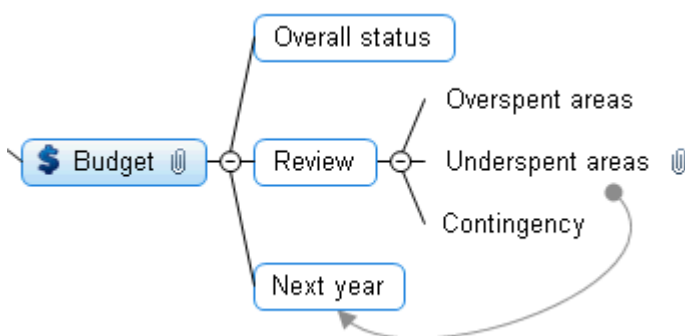

The paperclip icon appears to the right of the Underspent areas branch, denoting the presence of the branch connection.

If you select the Underspent areas branch again, you will notice that the branch connection is also listed in its Object list. By default, it bears the name of the branch where the connection ends.



## Formatting the branches



To finish off our map, we are going to add boundaries around the main branches.

At the start of this topic, we have seen how to choose global design options for the view using the **Design** tab.

If required, you can also apply specific design options to individual branches using the **Format** tab.

- Click the Opening remarks branch to select it.
- Click the **Format** tab that appears at the right of the ribbon.

This tab contains all the commands that are specific to the selected object, in this case the Opening remarks branch.

- Click the **Boundary** icon in the Boundary group.
- (optional) To choose a fill color for the boundary, click the small arrow under the **Fill Color** icon. This also lets you apply a color gradient, choose the direction of the gradient and change the start and end color of the gradient.
- (optional) To choose an outline style for the boundary, click the small arrow under the **Outline** icon. This lets you choose a different color for the outline, a different width or a different line type.

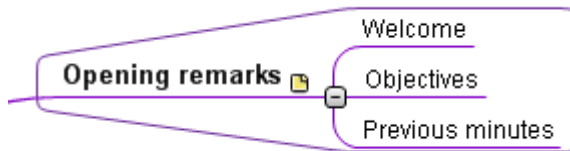

Properties	
General Text	
Text	Opening remarks
Fill Type	Solid
Fill Color 1	
Outline Color	
Outline Width	0
Line Color	
Line Width	3
Boundary	<input checked="" type="checkbox"/>
Boundary Fill Type	Solid
Boundary Fill Color 1	
Boundary Outline Color	
Boundary Outline Width	1
Boundary Outline Roundne	10
Boundary Outline Dash Sty	Solid
Include in Export	<input checked="" type="checkbox"/>

You can of course also use the Format tab to customize your branches further, by changing their shape, the color of their background and/or outline, the color and width of the line joining the branch to its parent branch and so on.



*If after experimenting with all these options, you want to restore your branches to the default style you chose for the view at the start of this topic, just press **Reset Style**.*

Our simple Quick Start example is now complete. In a very short time you have created and enhanced your first MindView mind map. You have also learnt the most common operations in MindView. Please refer to the User Guide for more information about any of the features described here.

# User Guide

## Setting up

### Setting up your workspace

The MindView window is made up of several components:

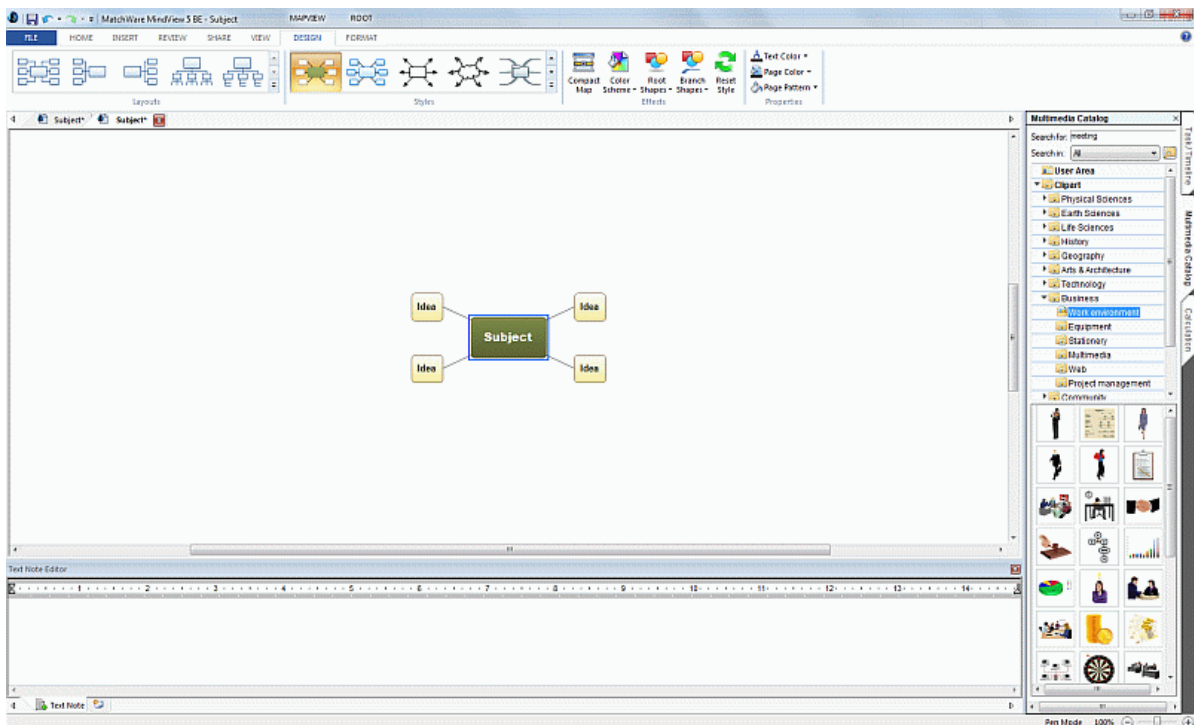

- The **File** menu is displayed in the upper left corner of the MindView window. It contains commands affecting the entire document, such as New, Open, Save, Print or Export.
- The **Quick Access Toolbar** is a component of the Microsoft Office interface. It is a customizable toolbar that is available at all times, regardless of the menu tab currently open on the ribbon. By default, it is located in the top left corner of the MindView window.
- The **Ribbon** is also a component of the Microsoft Office interface. Its tabs, corresponding to the main activities in MindView, contain all the necessary commands, options and icons, organized in groups. It is designed to help you quickly find the commands that you need to complete a task.

The **Design** tab that appears at the right of the ribbon is a special tab. It contains all the design options applicable to the current view.

When a particular branch or map element is selected, a **Format** tab may appear after the Design tab. It contains all the commands that are specific to the selected object.

- Three **Panels** can be displayed on the right of the MindView window.
- The **Workspace** is the area you use to design your document.

### Customizing the Quick Access Toolbar

The Quick Access Toolbar contains the most frequently used commands. By default, it is located in the top left corner of the MindView window.



To move the Quick Access Toolbar closer to the workspace area:

- Click the **Customize Quick Access Toolbar** arrow  on the right of the toolbar.
- Choose **Show Below the Ribbon**.

You can also add the commands you use most frequently to the Quick Access Toolbar, or remove commands you use less often. See "[Setting up your preferences](#)" for more information.

## Minimizing the ribbon

MindView lets you minimize the ribbon to increase the workspace available:

- Click the **Customize Quick Access Toolbar** arrow  on the right of the toolbar.
- Choose **Minimize the Ribbon**.
- To use the ribbon while it is minimized, click the tab you want to use, and then click the command you want to use.

As soon as you have made your choice, the ribbon returns to its minimized form.

- To restore the ribbon, click the Customize Quick Access Toolbar arrow again and uncheck Minimize the Ribbon.

You can also minimize the ribbon as follows:

- Double-click the current tab.
- To restore the ribbon, just double-click any of its tabs.



*You can also press **Ctrl + F1** to minimize or restore the ribbon.*

The layout of the commands, options and icons in the ribbon changes when the width of the MindView application window is reduced. Controls normally represented by large icons may for instance now be represented by small icons. If the width of the application window is greatly reduced, a group may be represented only by its icon.

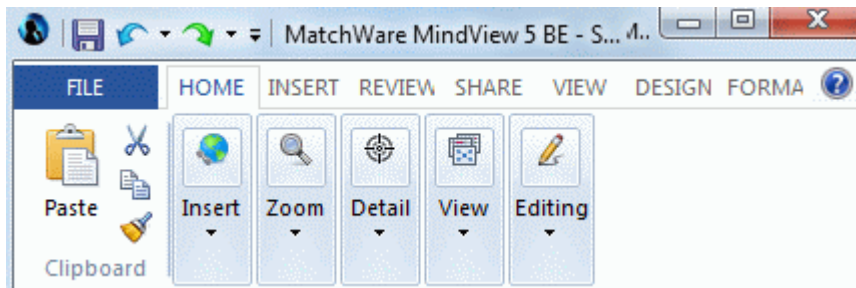

- To view the contents of such a collapsed group, just click its icon.

## Using access keys and shortcut keys

To select a command from the ribbon, all you need to do is click the relevant tab to open it, then choose the command.

You can also use access keys for this purpose. Access keys are different from shortcut keys.

- **Access keys** are used to navigate through the interface and select its different commands using the keyboard. Each command shown in the File menu, the Quick Access Toolbar and the Ribbon has an access key.
- **Shortcut keys** are key combinations such as F1 or Ctrl + O used to perform frequently used commands. Shortcut keys are not related to the organization of the commands in the interface. You will find a list of all the shortcut keys used in MindView in "[Keyboard shortcuts](#)".
- To select a command using an access key, start by pressing the **Alt** or **F10** key. You will now see the first layer of access keys you can use at that point displayed as small labels underneath each tab or command.



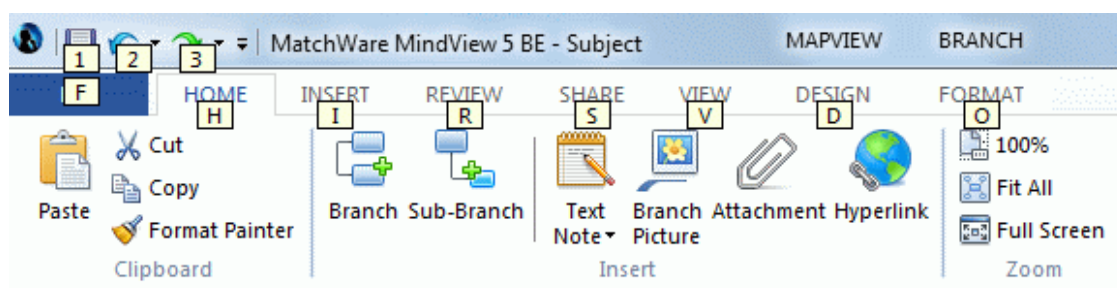

- Press the access key for the tab or command you require to see the second layer of access keys.

For instance, pressing **H** above will open the **Home** tab and display its access keys, as shown below.

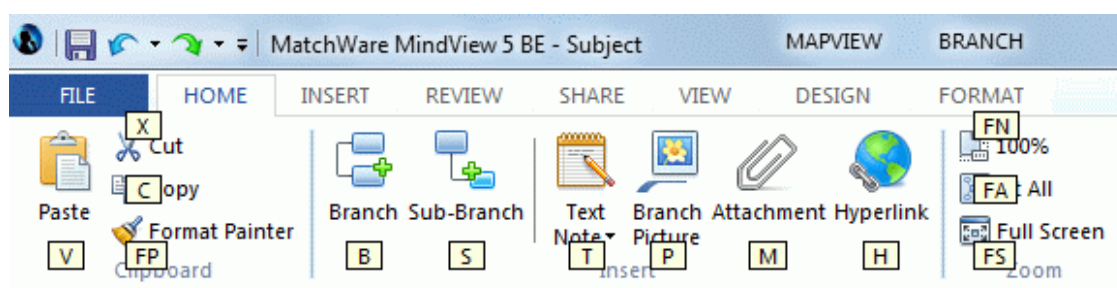

- Press the key or keys corresponding to the command you want to select.  
For instance, pressing **B** above will insert a branch in your map.

## Using the MindView panels

Three panels can be opened on the right of the MindView window:

- The **Task/Timeline** panel  
This panel lets you enter dates, times and other information on the branches of your mind map to create timelines, task lists or project plans.  
For more information on this panel, see "[Inserting timeline data](#)" and "[Inserting task data](#)".
- The **Multimedia Catalog**  
This catalog contains an extensive collection of high quality clipart pictures which you can add to your map to illustrate the topics.  
See "[Inserting pictures](#)" and "[Using the Multimedia Catalog](#)" for more information.
- The **Calculation** panel  
This panel lets you enter and modify values on the branches of your mind map, for instance sales numbers, costs, exchange rates and so on, as well as formulas to carry out calculations on the values.  
See "[Inserting calculation values](#)" for more information.

MindView includes other panels which you can show or hide using the **View | Show/Hide** command.

- The **Legend** panel  
This panel lets you add a legend to your map, to make it easier to read and interpret. For more information, see "[Creating a legend](#)".
- The **Text Note editor**  
The Text Note editor, which is placed by default at the bottom of the workspace, lets you associate comprehensive notes to the root or any branch of your map.  
See "[Inserting text notes](#)" for more information.

- The **Changes panel**  
This panel lists all the changes made to your map, by yourself or any other user who has access to it, provided that change tracking has been enabled.  
See "[Tracking changes](#)" for more information.
- The **Timeline Outline**  
This panel is only used in the Timeline view. It shows all the branches of your map as a hierarchical list which you can expand and collapse as required.
- The **Properties dialog**  
This dialog shows the properties of the MindView element currently selected, for example the root, a branch or a floating comment. If nothing is selected the properties of the current view are shown.  
See "[Using the Properties dialog](#)" for more information.
- The **Overview panel**  
The Overview panel allows you to bring the different parts of your map into view.  
See "[Using the Overview panel](#)" for more information.
- The **Object list**  
This lists all the objects placed on the currently selected branch of your map.  
See "[Using the Object list](#)" for more information.

## Resizing panels

- To resize a panel, move the pointer on one of its edges until it changes to a double arrow and drag with the mouse in the required direction.

## Undocking panels

The Task/Timeline panel, the Multimedia Catalog and the Calculation panel are always anchored on the right of the workspace.

All the other panels open by default on the left of the workspace, except for the Text Note editor, which opens at the bottom.

You can however move any of these panels freely on the workspace or dock them to a different position:



- To undock a panel, just drag its title bar away from its current position until it is completely free, then let go of the mouse button.



*You can also double-click the title bar of the panel to undock it and double-click it again to redock it. If you want to undock a panel and move it freely on the workspace without it "snapping" to a docked position, press the Ctrl key and hold it down while dragging the title bar of the panel.*

## Docking panels

You can dock an undocked panel to the left, top or bottom edge of the workspace as follows:

- Drag the title bar of the panel and move it in the direction required until you see the arrow shapes left , up  and down  appear on the edges of the workspace.
- Drag the panel on top of the required arrow until you see a darker shade of blue outline the new position. Release the mouse button if you are happy with this new position, else continue dragging to the required position.

You can also dock a panel above, below or on the side of another panel. To do this:

- Drag the title bar of the panel and move it in the direction of the target panel until you see a three-arrow shape appear.

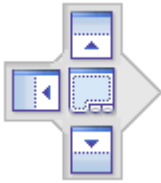

You now have different possibilities:

- Moving the panel over the left, up or down arrow will dock it on the corresponding side of the underlying panel.

Here for instance, the Object list is being docked to the left of the Properties dialog.

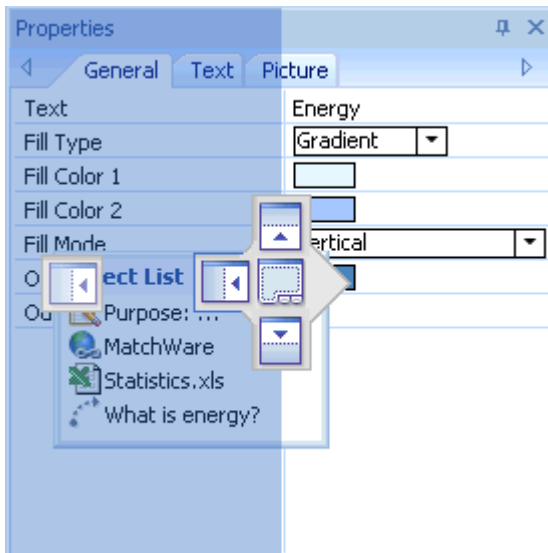

- Moving the panel to the middle square will integrate it as a tab of the underlying panel, converting it to a multi-tab panel.

Here, the Object list is being integrated with the Properties dialog as a tabbed panel.

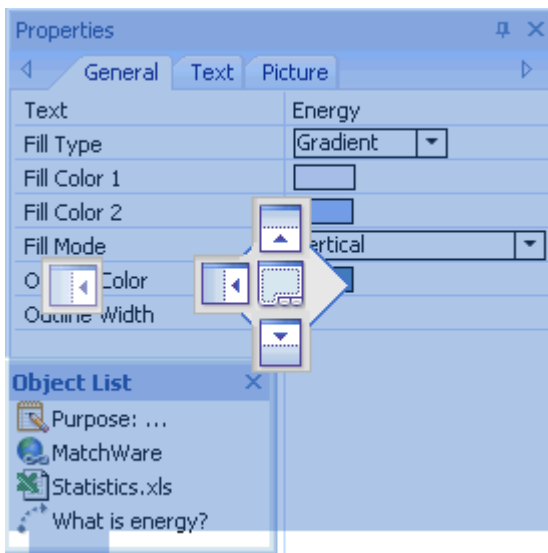

- To free such a tabbed panel, drag it by clicking its tab, not its title bar.  
To separate the Object list from the Properties dialog in the example below, you would therefore click the Object List tab.

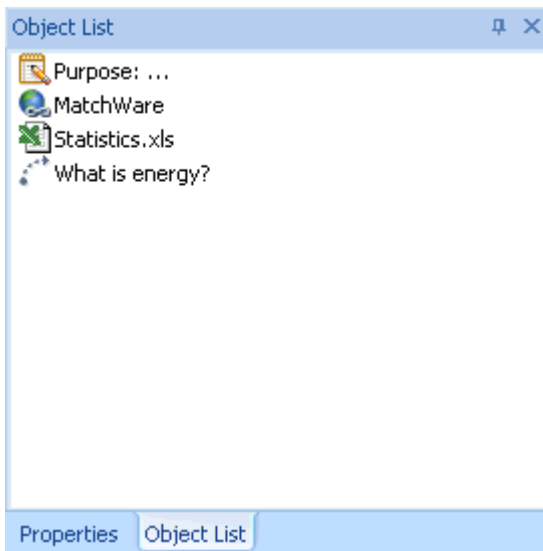

## Resetting panels to their default position

If necessary, you can reset all the panels to the default position they had when you first installed MindView:

- Click the **File** tab.
- Click **MindView Options** in the bottom right of the dialog.
- Click **Preferences** on the left.
- Set **Reset Interface** to Yes.
- Click OK.

When using this command, note that other components, such as the Quick Access Toolbar or the list of recently opened files, are also restored to their defaults.

## Setting up your preferences



The MindView Options dialog lets you customize your environment and gives you access to external web resources.

- Click the **File** tab.
- Click **MindView Options** in the bottom right of the panel.

The MindView Options dialog that opens contains several panels, corresponding to different options.

### Document

This dialog contains options relating to the current document, and are only applicable if this document is a Gantt project. For more information about Gantt projects, see "[Using the Gantt view](#)".

#### Scheduling options

These options relate to the different ways in which MindView can schedule each task of the Gantt project.

**New tasks are effort-driven:** This determines the effect of adding resources or removing resources from a task on the duration and work value of that task. For more information about effort-driven scheduling, see the topic "[Assigning resources](#)" and in particular the paragraph "[Understanding effort-driven scheduling](#)".

**Default task type:** This setting lets you choose a different default for the task type used by MindView to schedule each task. For more information about task types, see "[Using scheduling task types](#)".

### Currency options

These options relate to the costs you can associate with resources when working on the Gantt project. To find out how to do this, see "[Assigning resources](#)".

**Symbol:** This field lets you specify the currency symbol to be used when displaying resources costs on the mind map. You can enter here any currency symbol or any other symbol of your choice.

**Decimal digits:** The number of digits after the decimal separator to be used when displaying resources costs. You can enter any value between 0 and 9.

**Placement:** Use the drop-down to choose the placement of the currency symbol in the cost fields.

### Proofing

This dialog contains various options which you can set to determine the type of errors reported by the spellchecker.

It is described in detail in the topic "[Spellchecking options](#)".

### Save

**Create backup of document files:** Creates a backup of the MindView file and saves it as a \*.bak file. The \*.bak file is a copy of the last saved version of your document. See "[Saving a mind map](#)" for more information on this feature.

**Save auto-recovery info:** MindView automatically saves a copy of your open documents at regular intervals in a temporary backup file. If a problem occurs that prevents MindView from closing properly, you can choose to auto-recover your file from this backup file when next starting MindView. This field allows you to set the interval between automatic saves.

### Preferences

#### Display options

**Enable live preview:** When this option is enabled, MindView shows a preview of how particular choices affect the map as you browse through them. When designing a mind map for instance, you can browse through the different styles shown in the Styles gallery to choose your favorite style. If this option is enabled, you see an immediate preview of the result on your mind map as you hover over each style.

**Draw map antialiased:** Antialiasing improves the appearance of your map by smoothing its edges. This option is enabled by default. However, antialiasing makes a heavy use of the computer resources. If your computer has limited power, you might prefer to disable this option to speed up the display of the map.

**Draw text antialiased:** This option is disabled by default. However, text looks smoother when it is antialiased. Enable this option if your computer resources allow it.

**Show Welcome dialog on startup:** If you disable this option, MindView displays an empty workspace when starting rather than the Welcome dialog. See "[Creating a mind map](#)" for more information.

**Show Interactive Whiteboard Help dialog:** This option is only relevant when you are working in pen mode using an interactive white board. When it is enabled, a help message appears every time you put a pen back in the tray if the workspace still contains ink data that has not yet been added to the document. For more information, see "[Working in Pen Mode](#)".

**Show simplified user interface:** This option, of particular interest to novice users and younger students, restricts the user interface to the most commonly used menus and commands. You can return to the full interface at any time by disabling it. You can also switch to the simplified interface by choosing **View | Window | Simple Interface**.



**Reset Multimedia Catalog:** Setting this to Yes restores the original contents of the Multimedia Catalog. Your User Area is left unchanged, but all the elements you might have added to any other category are removed. See "[Using the Multimedia Catalog](#)" for more information.

**Reset Interface:** Setting this to Yes resets all the panels to their default positions. When using this command, note that other components, such as the Quick Access Toolbar or the list of recently

opened files, are also restored to their defaults. See "[Using the MindView panels](#)" for more information on resizing and docking panels.

### Animation options

These options allow you to disable the animation effects used by MindView if your computer is not powerful enough to produce a good result. If the animation effects appear slow and jerky rather than fast and smooth, you can disable them.

- **Comments:** This relates to the way the comment window opens when you insert or edit a yellow pop-up comment .
- **Object list pop-up:** This relates to the way the Object list pop-up opens when you move the mouse pointer over the paperclip icon  shown next to the label of any branch containing attached objects.

The next three options are only available in Windows Vista and above:

- **Zoom:** This relates to the way the map is displayed by increments when zooming in and out.
- **Animation time:** This is the time (in milliseconds) a scroll or zoom animation will take.
- **Animation distance factor:** This factor makes the duration of the scroll or zoom animation proportional to its distance. For instance, when scrolling from one branch to another branch placed some distance away on the screen, the higher this factor, the longer the animation will take.

### Text Note editor options

**Default font:** This field lets you specify a default font, text style, text size and text color for all the text notes you enter using the Text Note editor. To access these options, just select the field and click the three dots that appear at its right end. You can of course change these settings for individual text notes when working in the editor. For more information about the Text Note editor, see "[Inserting text notes](#)".

### Project Management options



These options control the defaults MindView applies to any new Gantt project you create. For more information about Gantt projects, see "[Using the Gantt view](#)".



*You can change these options for a particular document by using the **Document** panel described above, or the **Document Properties** dialog (click the **File** tab and choose **Prepare | Properties**).*

For detailed information about these options, see the description of the [Document](#) panel above.

### Undo options

The Undo feature lets you reverse any operation you have performed on your map. This gives you the freedom to experiment, as you can easily undo the last change made by choosing **Undo**  in the Quick Access Toolbar (or **Ctrl + Z**), and reapply the change if necessary with **Redo**  or (**Ctrl + Y**).

Note that you can also click the arrow to the right of the Undo icon to select a number of changes to undo. Similarly, the Redo icon allows you to restore the last change or changes undone.

**Undo levels:** This field lets you specify the maximum number of changes that you want to be able to undo. If for instance you set the number of Undo levels to 5, you will be able to reverse up to 5 changes by selecting the changes in the Undo list  or pressing **Ctrl + Z** several times. Note that increasing the number of undo levels increases the amount of memory used.

### Updates options

**Check for program updates:** This option allows MindView to check automatically for program updates on the MatchWare web site at the start of the program.

**Frequency of the checks:** Specify here how often the checks should occur (in days).

## Calendar

This tab is only relevant if you intend to create project plans for use in the Gantt view. It lets you modify the default calendar settings which provide the basic information about working and non-working time used by MindView to schedule the tasks of a project plan.

For details about how to use this dialog, see "[Defining calendars](#)" in the "Gantt view" chapter. For general information about the Gantt view, see "[Using the Gantt view](#)".

## Customize

This panel lets you add the commands you use most frequently to the Quick Access Toolbar, or remove commands you use less often.

- In the field **Choose commands from**, choose the ribbon tab containing the required command.
- Choose the required command in the **Commands** field and click **Add**.  
You can also add entire groups to the Quick Access Toolbar. Groups are denoted by a drop-down symbol .



*A quicker way to add a command to the Quick Access Toolbar is to click the ribbon tab containing the command you want to add, right-click the command and choose **Add to Quick Access Toolbar**.*

Clicking **Reset** will restore the original contents of the Quick Access Toolbar.



You can also access this panel by clicking the **Customize Quick Access Toolbar** arrow  on the right of the toolbar.

## Pen Input

This dialog is only displayed if your operating system supports pen input. It lets you choose different input options when working in Pen Mode. For more information, see "[Working in Pen Mode](#)".

## Resources

This dialog lets you access the MatchWare web site and obtain the latest product updates.

It also lets you enter a different serial number, for instance for converting a demonstration version of MindView to a full version, or for converting a standard version to the Business Edition.



## Basic tasks

### Creating a mind map



When you start MindView, the first screen you see is the **Welcome** dialog.

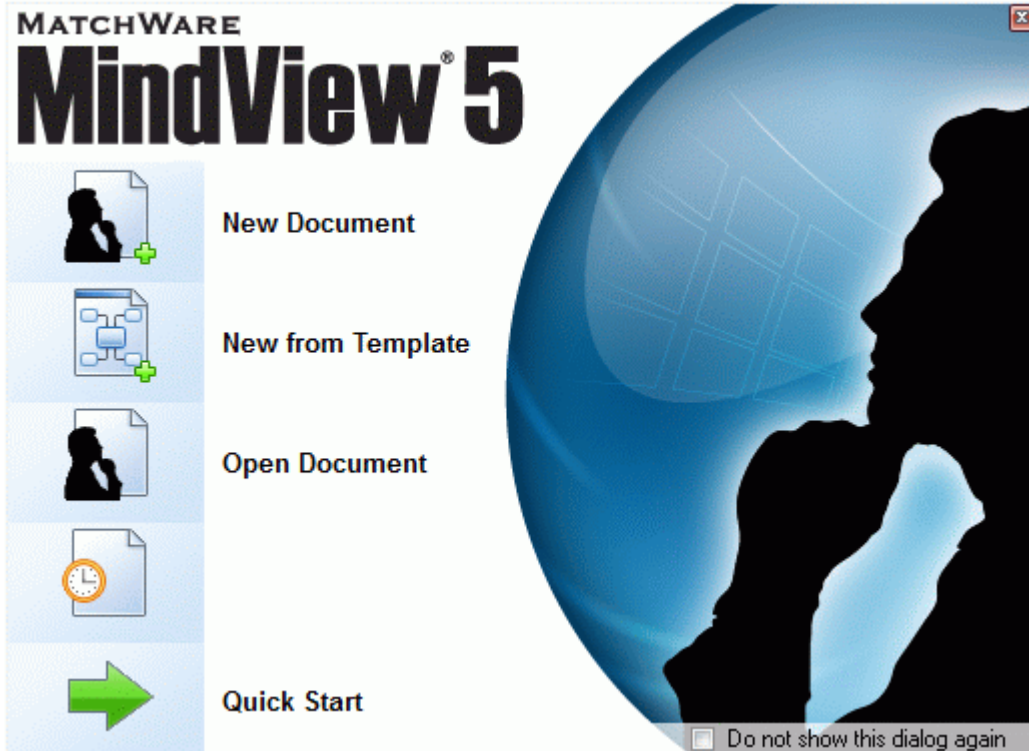

Here you can select to:

- Create a new document from scratch
- Create a new document based on a template
- Open an existing document
- Open a recently used document



You can check 'Do not show this dialog again' to bypass this dialog next time you start MindView. If you want to show the Welcome dialog again at a later stage, click 'Show Welcome dialog on startup' in the MindView Options dialog. See "[Setting up your preferences](#)" for more information.

- Choose **New Document** to create a new mind map document.



Although the topics in the "Basic tasks" and "Further tasks" sections of this documentation assume that you are using one of the standard Map views, namely Mind Map, Top Down or Left/Right, most of the procedures they describe apply equally to *all* views. Procedures that are specific to particular views are described in the topics dealing with these views in the Views section of this documentation.

### Creating a new document

The **New Document** dialog allows you to create an empty document based on one of the six views provided, namely **Mind Map**, **Top Down**, **Left/Right**, **Timeline**, **Outline** and **Gantt**.

See "[Using different views](#)" for more information about each view.





*If you have closed the Welcome dialog, you can also display this dialog by pressing **Ctrl + N**.*

Once you have created your document, you can display it at any time in another view by choosing that view in the **Home | View** or **View | View** panels in the main menu or by right-clicking the workspace and choosing **View Map As** in the local menu.

Going from one view to another only affects the way the document is displayed. The contents of the document are not modified, unless you edit them yourself while working in the new view.

The only exception to this rule is the Gantt view. Going to the Gantt view automatically enables project management features. This may have consequences for your data. See "[Using the Gantt view](#)" for more information.

- Click one of the thumbnails.
- Click **Open**.

The map appears with the root block ready for you to fill in.

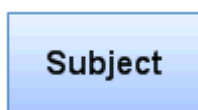

See "[Entering a branch label](#)" to find out how to do this.

## Using a template



The **New from Template** option of the Welcome dialog allows you to create a document based on one of the many educational, business and personal templates included in MindView, or on one of your own templates. The curriculum-aligned educational templates cover a range of learning levels and are supported by over a thousand high quality clipart images created specifically to match all areas of the curriculum.

MindView also includes various ready-made project plans for common business activities (organizing a tradeshow, producing a publication, launching a product and so on) for use in the Gantt view. You can use these for training purposes, or as a basis for your own project plans.

Once you have created your mind map from one of these templates, you can easily tailor it to meet your particular needs. Ideas and suggestions for expansion are given in text notes and pop-up comments.

If you have already created and saved your own templates, you can base your new mind map on one of them by selecting it in the My Templates category. See "[Saving a mind map](#)" for more information on how to save templates.

You can see a preview of each template by moving the pointer over its name on the right part of the dialog.

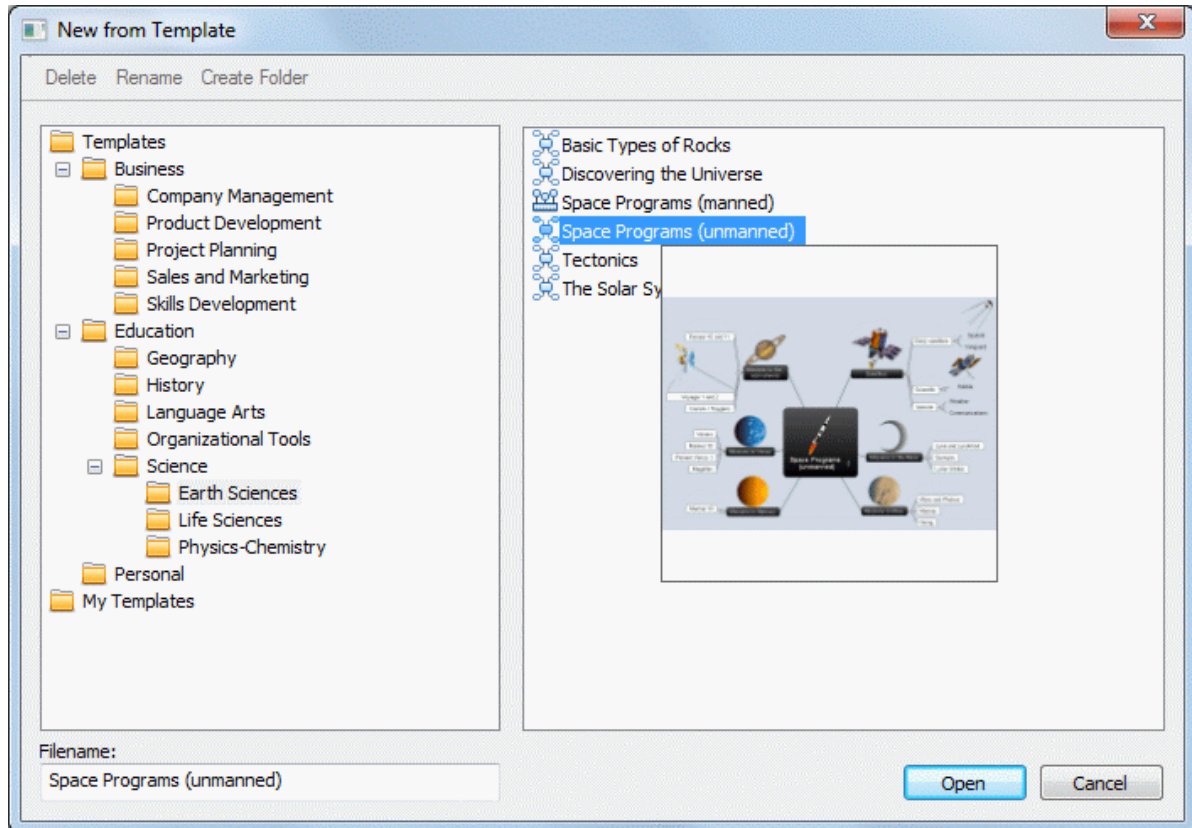

 You can also display this dialog by clicking the **File** tab and choosing **New | New From Template**.

## Saving a mind map





MindView documents are saved as .mvdX files.

To save a document:

- Click the **File** tab.

You can now choose either:

- **Save** to save your document under its existing name and continue working in MindView.
- **Save As | MindView Document** to save your document under a different name. This is also a way of creating a copy of your document.
- **Save Online** to save your document to a shared online workspace. For more information about online workspaces, see "[Setting up an online workspace](#)" and the other topics of the "Collaborating" chapter of this documentation.

 To save your document, you can also just click the **Save icon**  in the Quick Access Toolbar or press **Ctrl + S**.

 You can get MindView to save the previous version of your document automatically as a .bak file by enabling **Create backup of document files** in the Save panel of the MindView Options dialog. For more information on that dialog, see "[Setting up your preferences](#)".

## Recovering a backup file (\*.bak)

If you save a document after having made some changes which you wish you had not made, you can restore the previous version of the document as follows:

- Click the **File** tab and choose **Open**.
- Browse to the folder containing your MindView document and enter the file name \*.\* in the Open dialog to view the list of all the files contained in that folder.
- Select the *filename*.bak file, where *filename* is the name of your MindView document and click Open.
- Click the **File** tab and choose **Save As | MindView Document** to save the .bak file under its original .mvdX name to overwrite the incorrect version of the document.

## Auto-recovery

By default, a temporary copy of your document is also saved automatically at regular intervals to allow auto-recovery in the event of a program failure. To disable automatic saving of auto-recovery information, uncheck **Save auto-recovery info** in the Save panel of the MindView Options dialog.

## Saving your document as a template



You can also save your document as a custom template for future use. This allows you to create new documents based on your existing ones. To do this:

- Click the **File** tab.
- Choose **Save As | MindView Template**.

The **Save as Template** dialog appears.

If you have already saved some documents as templates, they will be listed in the left part of the dialog. Clicking a template gives you a preview of it on the right part of the dialog.

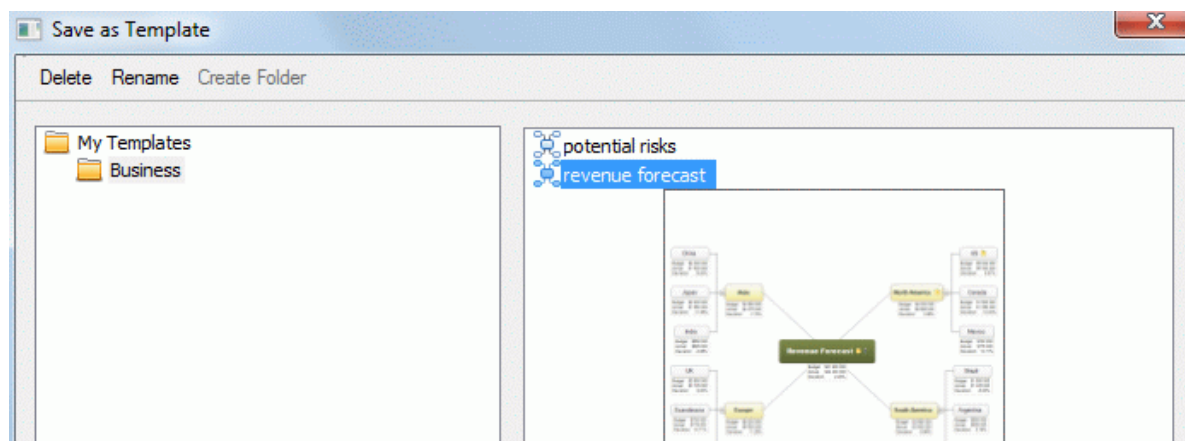

### To create a sub-folder in the My Templates folder:

- Click **Create Folder** and enter the name of your sub-folder.

### To save a document as a template:

- Click the name of the folder in which you want to save the template.
- Enter the name of your new template in the **Filename** field at the bottom of the dialog and click **Save**.

### To overwrite an existing template:

- Select the existing template and click **Save** to overwrite it with your new template.

### To rename a folder or template:

- Select the folder or template to rename and click **Rename**.

### To delete a folder or template:

- Select the folder or template to be deleted and click **Delete**.



Custom templates are saved with the extension .mvtx.

## Opening a mind map



When you start MindView, the first screen you see is the Welcome dialog. This dialog lets you browse for an existing document or select a recently used document.

If you have closed the Welcome dialog, you can open an existing document as follows:

- Click the **File** tab.
- Choose **Open**.



You can also press **Ctrl + O**.



MindView also lets you open online documents. For more information about working collaboratively on documents hosted on a shared online workspace, see "[Setting up an online workspace](#)" and the other topics of the "Collaborating" chapter of this documentation.

Note that you can open several mind maps in MindView at the same time. Each one is displayed in a separate tab in the MindView workspace and is treated as a separate document.



An asterisk on the right of the document name indicates that you have made changes to the document which you have not yet saved.



You can easily go from one document to the other by clicking the relevant tab or pressing **Ctrl + Tab**.

### Notes:

- If you are trying to open a password-protected document created with MindView Business Edition, you will need to enter the password before proceeding.
- If the document you are opening was saved with a branch focus or a filter to restrict the display of the map to specific branches, a message warns you that you may be viewing only part of the map. Click the **Clear Branch Focus** or **Clear Filter** button next to the message to see the entire map. For more information about branch focus and filters, see "[Focusing on a branch](#)" and "[Filtering a mind map](#)" respectively.

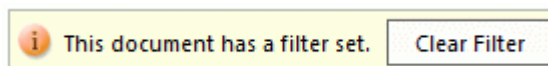
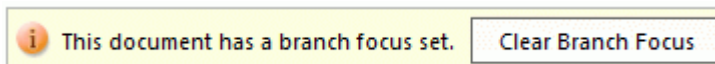

- If you open a document created with MindView Business Edition in the standard version of MindView, any data relating to MindView Business Edition features which are not supported in the standard version (such as task data or calculation values) will not be visible. If you then save the file in the standard version of MindView, this data will be lost. If the file has been password-protected in MindView Business Edition, this password will also be removed when saving the file in the standard version.
- MindView also lets you open MindManager® files (with extension .mmap) from version X5 onwards.

## Opening documents created with previous versions of MindView

MindView 5 lets you open documents created with previous versions of MindView. However once you make changes to the document and save it with MindView 5, the document is no longer compatible with the previous version.

### Entering a branch label

By default, the root of a newly created mind map contains the label "Subject" and new branches appear with the label "Idea".

### Replacing the default label

- Just click the root or branch to select it and start typing.
- When you have finished, press **Enter** or click outside the root or branch.

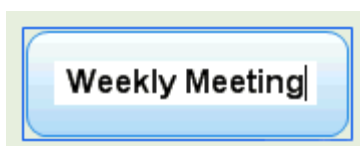

Unless your label is quite short, a resizing handle appears when you hover the right side of the frame surrounding the label. You can use this handle to resize the branch label by dragging it in the direction required.



By default, the text wraps around automatically when you type long labels. If you want to force the next part of your label to start on a new line, press **Ctrl + Enter** at the end of the line. You can disable the automatic text wrapping by unchecking the relevant property in the View properties. See "[View properties: General tab](#)" for more information.



Your map will be clearer if you keep your root and branch labels short. If you need to enter longer notes, use the Text Note editor. You can also enter comments to serve as reminders while you build up your map. See "[Inserting text notes](#)" and "[Inserting comments](#)" for more information.



Branch labels can be read aloud. To do this, click the branch to select it and choose **Review | Proofing | Narrate** (or press **F5**). You can stop the narrating by clicking the icon or pressing **F5** again. To resume, hold down **Ctrl** while clicking the icon or pressing **F5**.

### Editing a label

- To replace the existing label, just click the branch to select it and start typing the new label.

You can also edit the existing label. Here are different ways of entering Edit mode:

- Select the branch and click the label, or
- Select the branch and press **F2**, or
- Right-click the branch and choose **Edit Text** in its local menu.

Once you are in Edit mode:

- Place the cursor at the required position and start typing.
- When you have finished, press **Enter** or click outside the label.



Pressing **Esc** while in Edit mode will leave the existing label unchanged.

### Inserting branches

MindView lets you insert main branches, sub-branches and pre-branches in your mind map:

- A **main branch**  is a branch directly connected to the root. Main branches represent the main topics related to the subject of your map.

- A **sub-branch**  is a branch belonging either to a main branch or to a sub-branch of higher level.

Sub-branches represent the various levels of sub-topics in your map.

- A **pre-branch**  is a branch you insert before a sub-branch.

MindView automatically arranges the main branches, sub-branches and pre-branches as you insert them to prevent any overlap.

 You can however choose to reposition the main branches yourself after their insertion by disabling *Auto-layout mode*. See "[Moving a branch](#)" for more information.

As soon as you add a branch, sub-branch or pre-branch, the new branch appears with the default label "Idea". The procedure for replacing the default label is the same as for the root. See "[Entering a branch label](#)" for more information.

### Inserting a main branch



To insert a main branch:

- Click the root and press **Enter** or **Insert**.

You can also:

- **Double-click** the root, or
- Click the root and choose **Home | Insert | Branch** or **Home | Insert | Sub-Branch**, or
- Click the root and choose **Insert | Branches | Branch** or **Insert | Branches | Sub-Branch**, or
- Right-click the root and choose **Insert | Branch** or **Insert | Sub-Branch** in its local menu.



### Inserting branches at the same level



To add a branch at the same level as an existing branch:

- Click the existing branch and press **Enter**.

You can also:

- Click the branch and choose **Home | Insert | Branch**, or
- Click the branch and choose **Insert | Branches | Branch**, or
- Right-click the branch and choose **Insert | Branch** in its local menu.

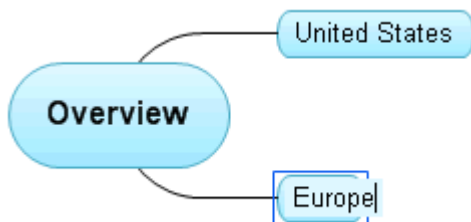



## Inserting a sub-branch



To add a sub-branch to an existing branch:

- Click the existing branch and press **Insert**.

You can also:

- **Double-click** the branch, or
- Click the branch and choose **Home | Insert | Sub-Branch**, or
- Click the branch and choose **Insert | Branches | Sub-Branch**, or
- Right-click the branch and choose **Insert | Sub-Branch** in its local menu.

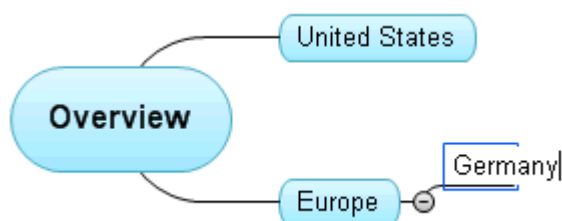

## Inserting a pre-branch



To insert a branch between an existing branch and its parent branch, you can:

- Click the branch and press **Shift + Enter**, or
- Click the branch and choose **Insert | Branches | Pre-Branch**, or
- Right-click the branch and choose **Insert | Pre-Branch** in its local menu.

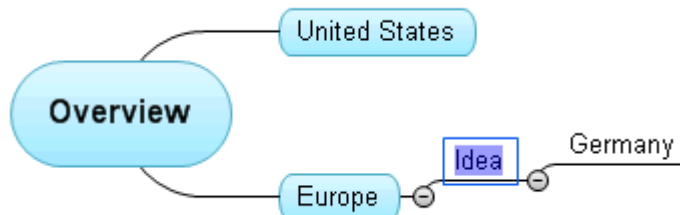

## Formatting a branch

As soon as you insert a branch in the map, a **Format** tab appears at the right of the ribbon.

This tab lets you perform different operations on the branch, such as changing its shape, choosing a different fill color, defining a branch boundary, or selecting different text attributes. See "[Formatting a branch](#)" for more information.

To apply the same formatting attributes to all the branches, it is however much easier to use the **Design** tab, whose predefined styles and design options apply to the entire map. See "[Designing a mind map](#)" for more information.

## Copying branches from an external application



You can easily create a branch structure with main branches and sub-branches by copying several lines of text from an external document, such as a Microsoft Word document, a Notepad text file or a Microsoft Excel spreadsheet, and pasting them into your MindView document. Any line indented with spaces or tabs in the external application will be inserted as a sub-branch of the higher level line.

Similarly, you can copy a MindView branch structure to another application by copying it from MindView and pasting it in the external application.

## Expanding and collapsing a branch

As soon as you add a sub-branch to a main branch or to another sub-branch, a small minus sign  appears between it and the higher-level branch. This allows you to hide the newly inserted sub-branch and any further sub-branches and concentrate on the higher-level branches. There are several ways to do this:

- Click the minus sign , or
- Right-click the higher-level branch and choose **Collapse** in its local menu, or
- Press **Ctrl + Shift + "-"**.

The sub-branch is now hidden, and the minus sign  changes to a plus sign .



To redisplay the sub-branch with all its sub-branches, do one of the following:

- Click the plus sign , or
- Right-click the higher-level branch and choose **Expand** in its local menu, or
- Press **Ctrl + Shift + "+"**.

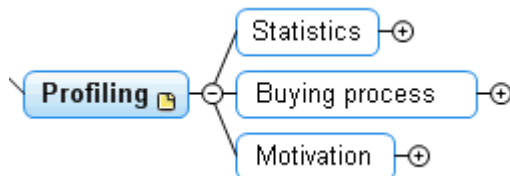

## Navigating between branches

To select a branch, all you need to do is click its label.

The following keyboard shortcuts allow you to navigate easily from one branch to the other:



- |              |  |
|--------------|--|
| <b>Up</b>    | Select the branch placed above the currently selected branch.    |
| <b>Down</b>  | Select the branch placed below the currently selected branch.    |
| <b>Left</b>  | Select the branch to the left of the currently selected branch.  |
| <b>Right</b> | Select the branch to the right of the currently selected branch. |

## Deleting a branch

There are several ways of doing this:

- Click the branch you want to delete and press **Delete**, or
- Click the branch and choose **Home | Editing | Delete**  in the main menu, or
- Right-click the branch and choose **Delete | Entire Branch** in its local menu.

If a branch contains sub-branches, you can delete it without deleting its sub-branches by choosing **Delete | Branch Section** in its local menu. This causes the sub-branches to move up one level in the hierarchy to become sub-branches of the parent branch.

 Remember that if you delete a branch by accident, you can always cancel the deletion by clicking **Undo**  in the Quick Access Toolbar or pressing **Ctrl + Z**.



## Designing a mind map

You can customize the look of your map at any time by applying design options to it.



Most design options give you a live preview of their effect on the map. It is therefore easier to judge the overall effect once you have entered a few branches and sub-branches in the map.

- Click the **Design** tab at the right of the ribbon.

This tab contains all the design options applicable to the current view.

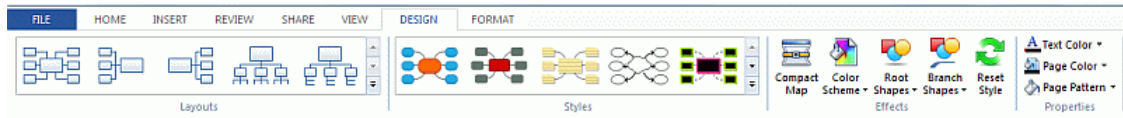

- Browse through the **Layouts** gallery to choose your preferred layout.

For more information about these views, see "[Using different views](#)".



The layouts available depend on the view you are using. If you are using one of the three Map views for instance, you can choose between the traditional Mind Map layout, the Left or Right layout or the Top Down layout.

- Browse through the **Styles** gallery to choose your preferred style.

MindView also lets you design your own style, using the Style Designer. For more information, see "Creating a custom style" below.

- (optional) To further customize the visual aspect of your map, explore the options available in the **Effects** and **Properties** panels.

If necessary, you can undo your changes and return the map to the initial style by choosing **Effects | Reset Style**.



All the design options you choose here apply to the entire map. You can however apply different design options to selected branches. To find out how to do this, refer to "[Formatting a branch](#)".



By default, MindView organizes the map so that the bounding areas containing the branches and their sub-branches do not overlap with each other. For some map layouts, this may create large empty spaces between branches which make the map harder to overview. In those cases, the **Compact Map** option may produce a better layout by bringing the branches as close to each other as possible, as shown in the examples below. Note however that the compact mode is more demanding on computer performance.

Mind map before compacting:

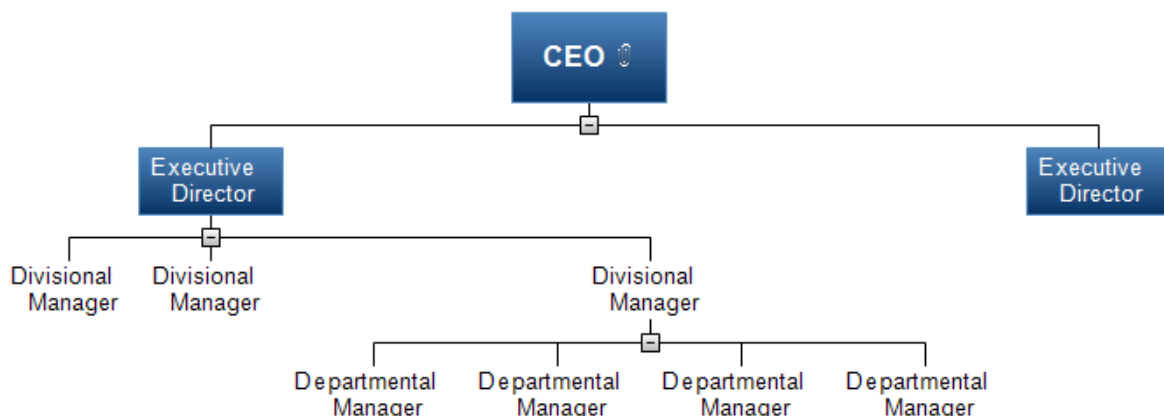

Mind map after compacting:

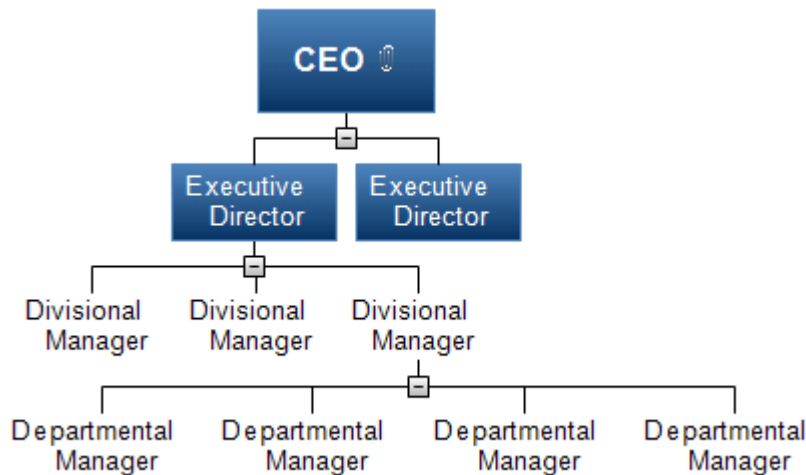

### Creating a custom style

You can create your own custom style, for re-use later, as follows:

- Choose **Custom Style** at the bottom of the **Styles** gallery, and choose **New** in the menu that opens.

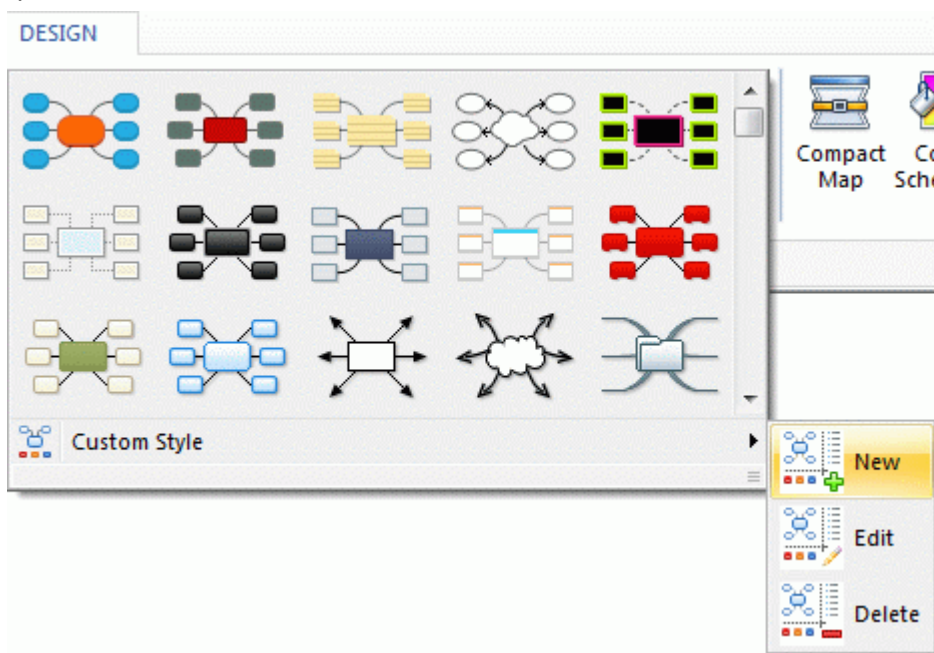

The **Custom Style Designer** window opens.

You can now make design changes applicable to the entire map, as described above. You can also make changes to specific branch levels, by selecting one branch at that level, and using the **Format** tab to choose the relevant attributes.

You can also customize the branch boundary shown around the first main branch by choosing a different fill color and outline for it. Just select the branch, click the **Format** tab, and select the required options in the **Boundary** panel. When applying this custom style to one of your maps in the future, branch boundaries will automatically adopt the boundary style created here.

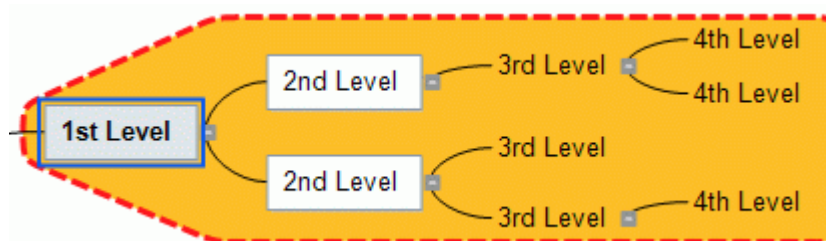

Similarly, you can customize the floating comment shown by selecting it, and using the options of the **Format** tab. When applying this custom style in the future, all the floating comments of your map will automatically inherit the attributes you choose here.

- When you have finished, click **Close Style Designer** in the **Style Designer** tab. A message appears to ask you if you want to keep your new style.

Once saved, your new custom style appears at the end of the Styles panel of the Design tab, after all the standard MindView styles. You can now select this custom style to apply it to your maps just as would choose one of the standard styles.

You can return to your custom style at any time to edit it further by choosing **Custom Style | Edit**, or delete it with **Custom Style | Delete**.

## View properties

In addition to the design options available on the Design tab, the view also has properties that you can edit in the Properties dialog. The Properties dialog always lists all the properties applicable to the element currently selected in the workspace.

- Click the workspace so that no other element is selected.
- Choose **View | Show/Hide | Properties** to open the Properties dialog.

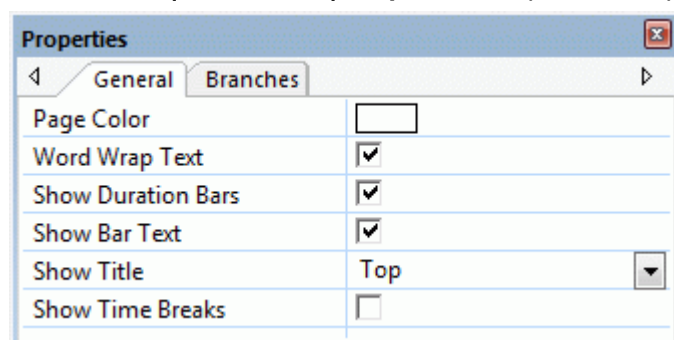

See "[Using the Properties dialog](#)" for a general description of the Properties dialog.

See "[View properties: General tab](#)" in the Reference section for a detailed description of the general properties applicable the view and "[View properties: Branches tab](#)" for a description of the default properties applicable to branches.

## Viewing a mind map

As your map grows, parts of it may fall outside the display area and no longer be visible.

### Scrolling the map

You can use the **scroll bars** or your **mouse scroll button** to bring them back into view:

- To scroll your map vertically, use the vertical scroll bar or the scroll button of your mouse.
- To scroll your map horizontally, use the horizontal scroll bar or press **Ctrl** while using the scroll button of your mouse.

## Panning the map

You can also **pan the view** to reach different areas as follows:



- Press the **Shift** key and drag the area of the view that you want to reposition within the workspace.

When you pan the view in this way, you will notice that the shape of the mouse pointer changes from an arrow to a hand.

You can also easily move the map within the workspace by dragging its root to the position of your choice.



## Viewing map details

There are other viewing options available to you:

- You can use the **Zoom** slider  or the **Zoom** icons of the View tab to change the level of magnification of your map. See "[Zooming in and out](#)" for more information.
- You can view the map in full screen mode by choosing **View | Zoom | Full Screen**  or pressing **F9**. To return to normal viewing mode, choose **Close Full Screen** in the floating Full Screen toolbar, press **Esc** or press **F9** again.
- If you want to present your map to others, you can focus on one branch at a time while you discuss the issues related to that branch by choosing **View | Detail | Focus Mode**  or pressing **F3**. As soon as you click the branch you want to concentrate on, the map becomes centered on that branch. If necessary, you can select a different zoom factor for maximum legibility by clicking the lower part of the Focus Mode icon.

To recenter the map on its root so that you can select other branches that may no longer be visible, just click anywhere on the workspace.

To return to the normal mode of working at the end of your presentation, click the Focus Mode icon again to deselect it or press **F3**.

- The **Detail Level** icons  of the View tab let you collapse the entire mind map to just one level of branches, two levels, three levels or four levels. To show all levels, click the **All Levels** icon .



*You can also press **Ctrl + 1** to display just one level of branches, **Ctrl + 2** to show two levels etc. **Ctrl + 5** shows all levels.*

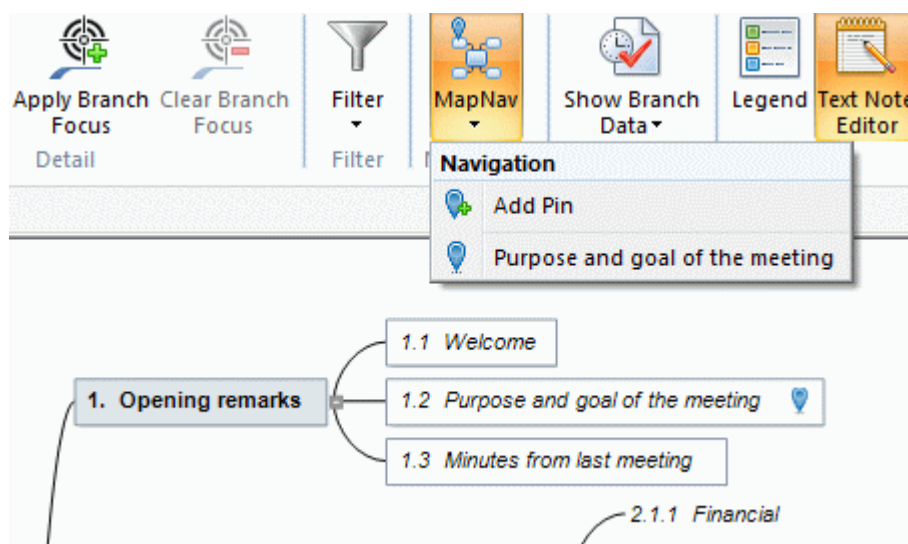

- The **Apply Branch Focus** icon  of the View tab allows you to restrict the display to a particular branch or set of branches. See "[Focusing on a branch](#)" for more information.
- The **Map Navigation** feature allows you to set pins (bookmarks) on your branches, in order to locate them quickly again in your map. To set a pin on a branch, select the branch, click the button **View | Navigation | MapNav** and choose **Add Pin** in its drop-down menu (or right-click the branch and choose **Insert | Navigation Pin** in its local menu).

The Navigation Pin icon  appears on the branch, and the branch name is now shown in the list that opens when you click the MapNav button.



When you are viewing another part of the map, you can now quickly navigate to the pinned branch by clicking again the MapNav button and selecting the branch name in the list. This selects the branch, and re-centers the map on the branch.

To remove a branch from the list of pinned branches, select it on the map, click the MapNav button and choose **Remove Pin** (or right-click the branch and choose **Delete | Navigation Pin** in its local menu).

- The **Numbering Scheme** icon  of the Home tab lets you apply sequential numbers to the branches of the mind map (starting from the top right in a clockwise direction) and choose between various numbering styles.
- The **Filter** icon  of the View tab lets you define criteria, and then locate the branches of your document that meet these criteria by hiding all the other branches. Using filters, you can for instance display only branches containing a specific label or timeline events starting at a specific date.  
See "[Filtering a mind map](#)" for more information.
- The **Overview** panel allows you to concentrate on particular areas of your map. See "[Using the Overview panel](#)" for more information.
- Branch labels, text notes and comments can be read aloud. To do this, select the element and choose **Review | Proofing | Narrate**  (or press **F5**). You can stop the narrating by clicking the icon or pressing F5 again. To resume, hold down **Ctrl** while clicking the icon or pressing F5.

## Viewing map statistics

You can also find out general information about your map, such as its total number of branches, its word count and its character count. You can do this in two ways:

- Choose **Review | Proofing | Document Statistics**, or
- Click the **File** tab and choose **Prepare | Properties**.

The second method gives you additional information, such as the document's author, its creation date, and other document properties.

## Zooming in and out



This topic describes the zoom features provided by MindView to let you change the level of magnification of your mind map.

Other MindView options let you focus on particular areas by hiding all the other branches, apply a filter based on the conditions you define, or choose the number of levels of branches to display. For a description of these options, see "[Viewing a mind map](#)".

The easiest way to change the level of magnification of your map is to use the **Zoom slider** shown in the bottom right of the workspace.



## Zooming in

There are several ways of zooming in on an area of your map:

- Click the **Zoom In** icon  of the Zoom slider shown in the bottom right of the workspace, or
- Press **Ctrl + "+"**, or
- Press **Alt** or **Shift** while scrolling your mouse wheel.

 The maximum zoom factor is 400%.

## Zooming out

Conversely, you can zoom out in several ways:

- Click the **Zoom Out** icon  of the Zoom slider shown in the bottom right of the workspace, or
- Press **Ctrl + "-"**, or
- Press **Alt** or **Shift** while scrolling your mouse wheel.

 The minimum zoom factor is 5%.

## Viewing the map at 100%

To view the map in its default zoom factor of 100%:

- Choose **View | Zoom | 100%**  in the main menu.

## Fitting the map to the workspace

To make the best possible use of the space available, you can resize the map so that it completely fills the workspace:

- Choose **View | Zoom | Fit All** , or press **F4**.

## Selecting a zoom factor

You can also choose a predefined zoom factor or enter your own zoom factor as follows:

- Choose **View | Zoom | Zoom**  in the main menu.

The **Zoom** dialog opens.

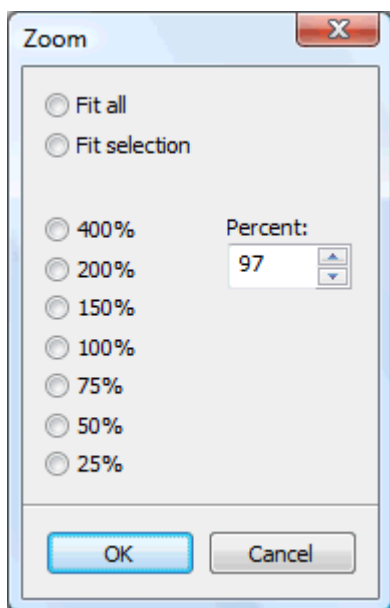

- Choose one of the predefined zoom factors or enter your own value.
  - **Fit all** resizes the map so that it completely fills the workspace.
  - **Fit selection** resizes the map so that the selected branch together with its sub-branches completely fills the workspace.



You can also open the Zoom dialog by clicking the left part of the Zoom slider



## Viewing the map in full screen mode

To give your map as much screen space as possible, you can temporarily hide all the menus and panels by viewing the map in full screen mode:

- Choose **View | Zoom | Full Screen** , or press **F9**.
- To return to normal viewing mode, choose **Close Full Screen** in the floating Full Screen toolbar, press **Esc** or press **F9** again.

## Inserting text notes



The MindView Text Note editor is a powerful tool which lets you add comprehensive text notes to the root and any branch or sub-branch of your map. You can add as many different text notes as you like to any of these elements.

- If the Text Note editor is not already visible, choose **View | Show/Hide | Text Note Editor** to open it.



You can resize, dock and undock the Text Note editor according to your needs. See "[Using the MindView panels](#)" in the topic "[Setting up your workspace](#)" for more information.



In addition to text notes, you can also associate brief comments to the branches of your map. For more information on comments, see "[Inserting comments](#)". You can also attach an entire text file to a branch by using the **Home | Insert | Attachment** command. For more information on attaching text files, see "[Attaching objects](#)".



Once created, a text note can be read aloud. To do this, click the Text Note editor window containing your note and choose **Review | Proofing | Narrate**  (or press **F5**). You can stop the narrating by clicking the icon or pressing **F5** again. To resume, hold down **Ctrl** while clicking the icon or pressing **F5**.





## Creating a text note

The easiest way to add a text note to a root or branch is as follows:

- Select the root or branch to which you want to add a text note.
- Click the Text Note editor window (or press **F8**) and start entering your note.

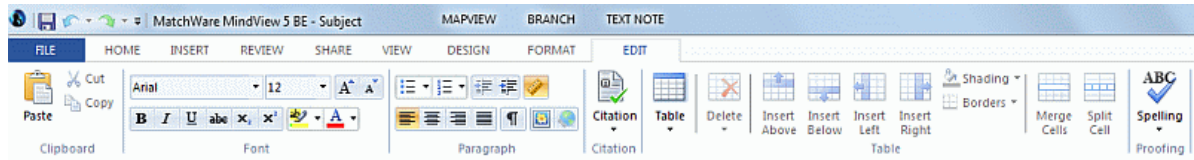
As soon as you click the Text Note editor window, an **Edit** tab appears at the right of the ribbon to help you format your note.



- You can now type text, paste text from the clipboard or even import text from an RTF file using the local menu.
- If necessary, click **Undo**  in the Quick Access Toolbar (or press **Ctrl + Z**) to undo the last change(s) made.
- Once you have finished editing your text, simply click outside the Text Note editor or select another branch.

 *Once you are out of text editing mode, clicking Undo will undo all the changes made in the text note since entering text editing mode.*

As soon as you select another branch or element in the map, the text note is automatically saved and added to the Object list of the root or branch. A paperclip icon  also appears to the right of the root or branch label to indicate the presence of an attached object. Moving the mouse pointer over the icon displays a pop-up list of all the objects attached.

## Adding a text note

You can attach an additional text note to a root or branch as follows:

- Click the **New Text Note** tab  at the bottom of the Text Note editor or press **Ctrl + F8**.

 When the Text Note editor is not visible, you can also enter a text note by selecting the relevant root or branch and choosing **Home | Insert | Text Note | New** or **Insert | Text | Text Note | New** in the main menu or **Insert | Text Note | New** in the local menu.

## Formatting a text note

Text editing in MindView works in the same way as with most word processors and you will recognize many of the commands below. Some of these commands are also included in the mini toolbar that appears when you select text with the mouse.

- To see what a particular icon does, place the mouse pointer over it until you see its descriptive label appear.

 *To select the entire contents of your text note, press **Ctrl + A**.*

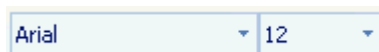

These fields let you view and change the **font** and **font size** of the currently selected text.

Note that you can set a default font, text size and text color for all the text notes you enter in the MindView Options dialog as follows:

- Click the **File** tab.
- Click **MindView Options** in the bottom right.
- Click **Preferences** on the left.
- Choose the required options in the Text Note editor section.





These icons let you increase and decrease the **font size** from their current values. If a piece of text is selected, the size of each character is increased (or decreased) individually from its current value.

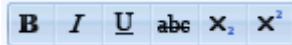

These icons help you set and remove **formatting attributes** in the usual way. You can set the selected characters as superscript or subscript by clicking the relevant icon.



The first of these icons let you change the **color** of the background of the selected text so that it looks highlighted. The second icon lets you change the color of the text itself.

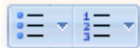

Use these icons to create **bulleted lists** or **numbered lists**. Place the pointer in the relevant paragraph or at the beginning of a new line and click the appropriate icon. Clicking the arrow next to the icon lets you choose between different bullet styles and numbering formats. Clicking the icon again removes the formatting.



Use these icons to increase or decrease the **indent level** of the selected paragraph.



To adjust margins and indents, click the **ruler** icon (if the ruler is not already displayed). Drag the margin markers  at the left and right ends of the ruler to change the left and right margins. Drag the indent marker (which by default is shown directly below the left margin marker on the ruler) to set the indent margin. To indent an entire paragraph (including the first line), set the indent marker to the required position and type a tab character at the beginning of the paragraph. You can insert standard tab stops by clicking the ruler and then dragging them into position. To remove tab stops, drag them away from the ruler.



These icons let you **align** the current paragraph within the text note. You can align it to the left margin, center it, align it to the right margin or justify it so that it is aligned with both left and right margins.



Clicking this icon displays all the special **marks** and **symbols** within your text note, such as line feeds and spaces. Click it again to hide these symbols.



Click this icon to insert a **picture** in the text note.

## Creating a hyperlink

- To convert the selected text to a **hyperlink**, click  or press **Ctrl + H**. This lets you create a link between the selected text and an external element such as a URL.
- To edit the hyperlink, press **Ctrl + H** again or choose **Edit Hyperlink** in its local menu.
- To delete a hyperlink, choose **Delete Hyperlink** in its local menu.
- To activate a hyperlink, press **Ctrl** while clicking the link.

You can set the format of the selected hyperlink as default for all hyperlinks by choosing **Default Hyperlink Style** in its local menu.

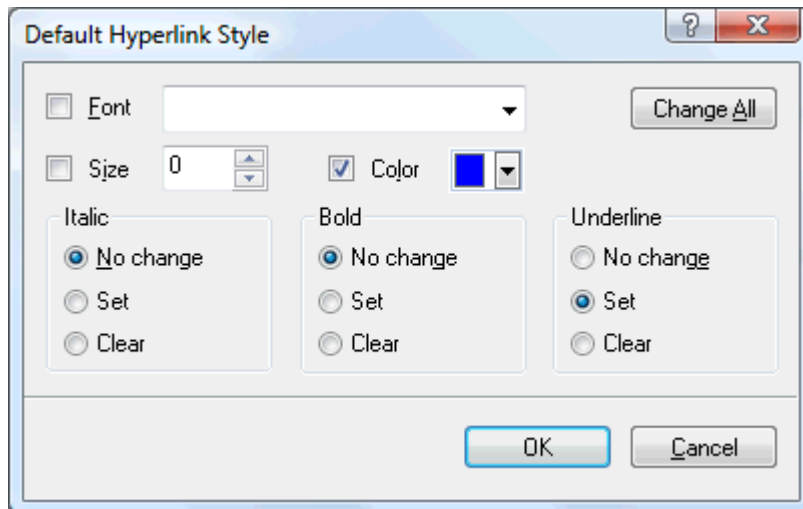

- If you select **No change**, the hyperlink keeps the current italic, bold or underline attribute.
- **Set** applies the relevant formatting (e.g. italic, bold or underline) to the hyperlink.
- **Clear** removes the relevant formatting from the hyperlink.

You can also select a font, size and color for the text by choosing a value and checking the box to the left of the relevant option to apply it.

The **Change All** button allows you to apply the options selected to all the existing hyperlinks.

## Creating a table

The next group of icons relates to tables.

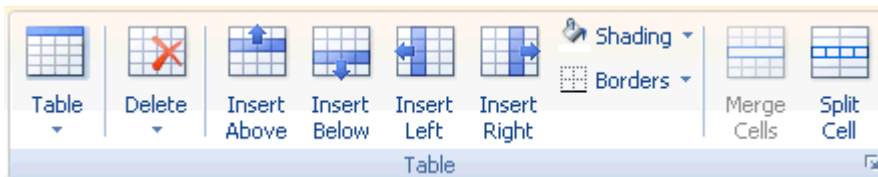

- To insert a table in your text note, click the **Table** icon and choose the initial number of rows and columns required. The table is inserted at the cursor position. To change the height of table rows, or the width of table columns, drag the row or column dividers. You can add and remove rows and columns later using the Insert commands.
- To delete the entire table, click the upper part of the **Delete** icon.
- To delete the selected cell(s), row(s) or column(s), click the arrow in the lower part of the **Delete** icon and choose the relevant command.
- To insert a row or column, place the cursor at the point of insertion, and choose the relevant **Insert** command.
- To change the interior color of the selected cell(s), choose **Shading** and select your preferred color.
- To add and remove borders or change the border color, choose **Borders**.

You can also change the interior and border colors of the cells by choosing **Borders and Shading** to open the dialog below.

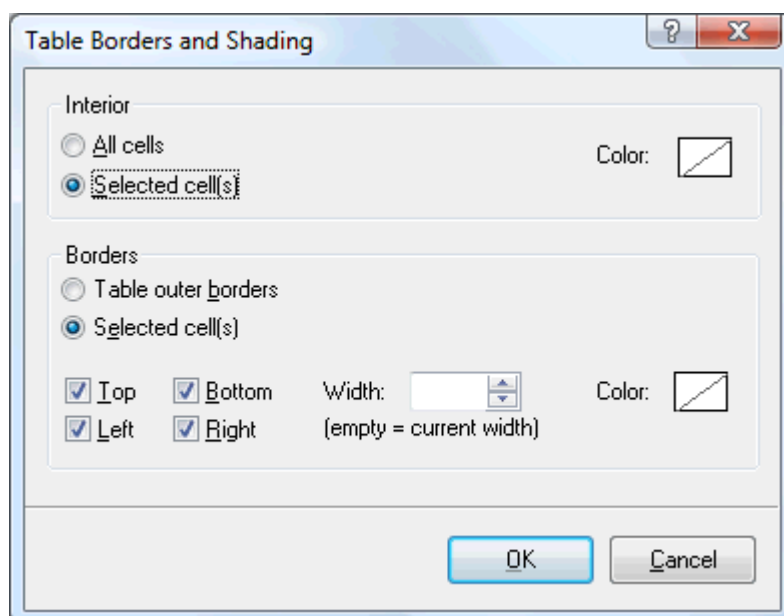

You can assign a background color to all the cells in the table or to the selected cells only. You can also assign a border width and color to the left, right, top or bottom edges of the entire table or to each of the selected cells. To keep the current border width, just leave the Width field empty. Similarly, to keep the current colors, leave the Color field(s) unchanged (diagonal line on a white background).

- To merge cells, select them and choose **Merge Cells**.
- To split a cell into two, select it and choose **Split Cell**.

## Adding a citation

MindView lets you add citations in your text notes to refer to the bibliography sources you have been using. For more information on this, refer to "[Using sources](#)" and "[Using citations](#)".

## Spellchecking a text note



To check the spelling of the text contained in your text note, choose **Spelling**.

Clicking the lower part of the icon will enable you to choose a different language and set the spelling options. See "[Using the spellchecker](#)" for more information about this feature.

## Selecting a text note

When several text notes are attached to a root or branch, you can display the one you want to view as follows:

- Click the tab corresponding to the required text note at the bottom of the Text Note editor, or
- Move the mouse pointer over the paperclip icon  to the right of the root or branch label and click the required text note in the pop-up list, or
- Click the required text note in the Object list of the root or branch.

## Deleting a text note

- To delete a text note, move the mouse pointer over the paperclip icon  to the right of the root or branch label, select the required text note in the pop-up list and choose **Delete** in its local menu.

You can also select it in the Object list and press **Delete** or choose **Delete** in its local menu.



*Remember that if you delete a text note by accident, you can always cancel the deletion by clicking **Undo**  in the Quick Access Toolbar or pressing **Ctrl + Z**.*

## Inserting comments

MindView lets you associate comments with the elements of your map, including the workspace itself, the root and any branch or sub-branch. There are two kinds of comments:

- Floating comments
- Pop-up comments



In addition to these types of comments, you can also associate longer text notes with the branches of your map. For more information on text notes, see "[Inserting text notes](#)".



Once created, both types of comments can be read aloud. To do this, click the comment window and choose **Review | Proofing | Narrate** (or press **F5**). You can stop the narrating by clicking the icon or pressing F5 again. To resume, hold down **Ctrl** while clicking the icon or pressing F5.

## Floating comments



Floating comments are brief notes that stay visible on the screen at all times. You can add as many floating comments as you like to the workspace itself, the root or any branch of your map.

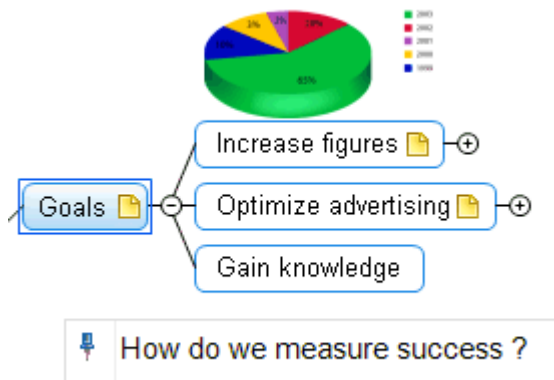

## Inserting a floating comment on a root or branch

- Select the root or branch to which you want to add a floating comment and choose **Insert | Text | Floating Comment** in the main menu or **Insert | Floating Comment** in the local menu.

A small window opens to let you type your comment, and a **Format** tab specific to the comment appears at the right of the ribbon.

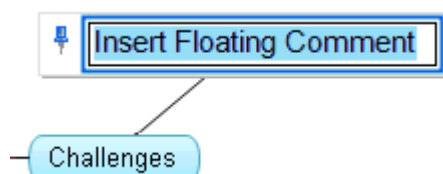

By default, the text wraps around automatically after a certain number of characters. If you want to force the next part of the comment to start on a new line, press **Ctrl + Enter** at the end of the first line.

- Once you've finished typing, press **Enter** or click outside the comment window. A thin line now connects your new comment with the root or branch you attached it to. If necessary, you can move your comment to a more convenient place by dragging it with the mouse or by using the arrow keys of the keyboard.
- (optional) Click the **Format** tab at the right of the ribbon. This tab contains formatting options applicable to the floating comment.

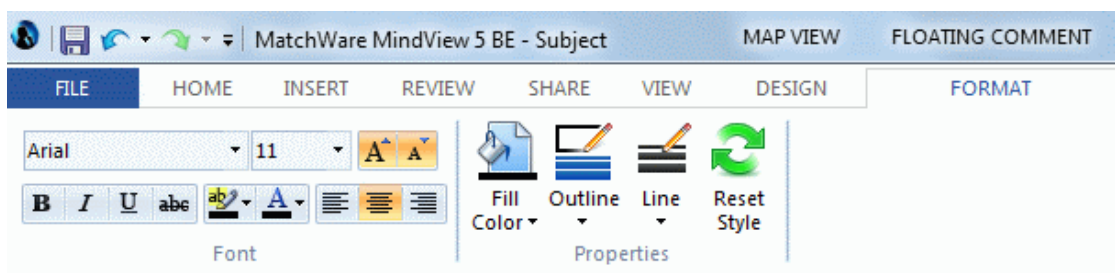

- Browse through the options available in the different panels, checking their effect on your floating comment as you go.

As well as the Format tab, you can also use the Properties dialog to make changes to the floating comment.

See "[Floating comment properties: General tab](#)" and "[Floating comment properties: Text tab](#)" in the Reference section for a detailed description of the properties applicable to a floating comment. For a general description of the Properties dialog, see "[Using the Properties dialog](#)".

### Inserting a floating comment on the workspace

- Right-click the workspace and choose **Insert | Floating Comment** in its local menu.

When you add a floating comment to the workspace in this way, the comment is not attached to anything and no connecting line is visible.

If necessary, you can then move your comment by dragging it with the mouse or by using the arrow keys of the keyboard. You can even connect it to a particular branch by moving it on top of its label.

### Editing a floating comment

- To replace the existing comment, just click it to select it and start typing the new comment.

You can also edit the existing comment. As for branch labels, there are several ways of entering Edit mode:

- Select the comment and click its text, or
- Select the comment and press **F2**, or
- Right-click the comment and choose **Edit Text** in its local menu.

Once you are in Edit mode:

- Place the cursor at the required position to edit the existing comment.
- When you have finished, press **Enter** or click outside the comment window.



Pressing **Esc** while in Edit mode will leave the existing comment unchanged.

### Detaching a floating comment

- To detach a floating comment from a root or branch, select the comment and choose **Detach** in its local menu.

The comment now belongs to the workspace itself rather than to the root or any of its branches.

### Deleting a floating comment

To delete a floating comment, select it and do one of the following:

- Press **Delete**, or
- Choose **Home | Editing | Delete**  in the main menu, or
- Choose **Delete** in its local menu.

## Pop-up comments



By contrast with floating comments, pop-up comments are normally hidden. You can add a pop-up comment to the root or to any branch of your map, but not to the workspace itself. This type of comment can be very useful as a "designer note" while you build your map. You could for instance insert a pop-up comment on a branch to list all the elements that you still need to add to that branch.

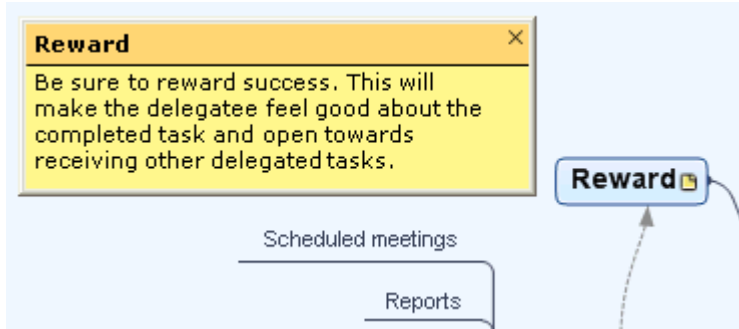

### Inserting a pop-up comment

- Select the root or branch to which you want to add a pop-up comment choose **Insert | Text | Comment** in the main menu or **Insert | Comment** in the local menu.



You can also just press **F11**.

The comment window opens to let you type your comment.

- (optional) Resize the comment window by placing the mouse pointer on one of its edges or corners and dragging in the required direction.
- Once you've finished typing, press **Esc**, click outside the comment window or click the **Close** icon in the top right corner of the comment window.

A yellow comment icon  now appears next to the branch name, indicating that there is a comment associated with this branch. Moving the mouse pointer over this yellow comment icon re-opens the comment window so that you can read the comment. As soon as you move the mouse pointer away from it, MindView hides the comment window again.

If necessary, you can easily move your comment to a more convenient place by dragging its title bar with the mouse.

### Editing a pop-up comment

There are several ways of entering Edit mode:

- Click the yellow comment icon on the right of the root or branch name, or
- Move the mouse pointer over the yellow comment icon and click the comment window, or
- Right-click the root or branch containing the pop-up comment and choose **Insert | Edit Comment** in its local menu.



You can also just press **F11**.

### Deleting a pop-up comment



There are two ways of doing this:

- Right-click the branch containing the comment and choose **Delete | Comment** in its local menu.
- Right-click the title bar of the comment window and choose **Delete** in its local menu.

## Inserting icons



MindView lets you place icons on the branches of your mind map to attract attention or illustrate a particular idea.

You could for instance use one of the Team icons  for all the topics of your map involving a discussion with others, or the Clock icon  for all topics associated with a deadline. Make sure however that you use such icons consistently and sparingly to avoid overloading the map.

### Inserting a MindView icon on a branch

- Select the branch to which you want to add an icon.
- Choose **Insert | Icons** to open the gallery of icons.
- Click the required icon.



The selected icon appears on the left of the branch name.



You can choose as many icons as you like in the Standard set. However, you can only choose one icon in each of the other sets. If for instance you have attached a Priority 3 icon to your branch, choosing a Priority 5 icon for the same branch will remove the Priority 3 icon and replace it with the Priority 5 icon.



Once you have inserted an icon from a set other than the Standard set on a branch, clicking that icon on the branch replaces it with the next icon in the set. If for instance you have inserted a Priority 3 icon on a branch, clicking it replaces it with the Priority 4 icon and so on until Priority 9, then Priority 1 again.

## Deleting an icon

You can delete an icon in two ways:

- Click the icon to select it, then choose **Delete Icon** in its local menu.  
You can also choose **Delete All Icons** to remove all the icons from the branch.
- Right-click the branch, choose **Delete | Icons** and select the icon to be deleted.



## Managing your own sets of icons

MindView also lets you create and modify your own sets of icons.

- Choose **Insert | Icons** to open the gallery of icons.
- Click **Custom Icons** at the bottom of the gallery.

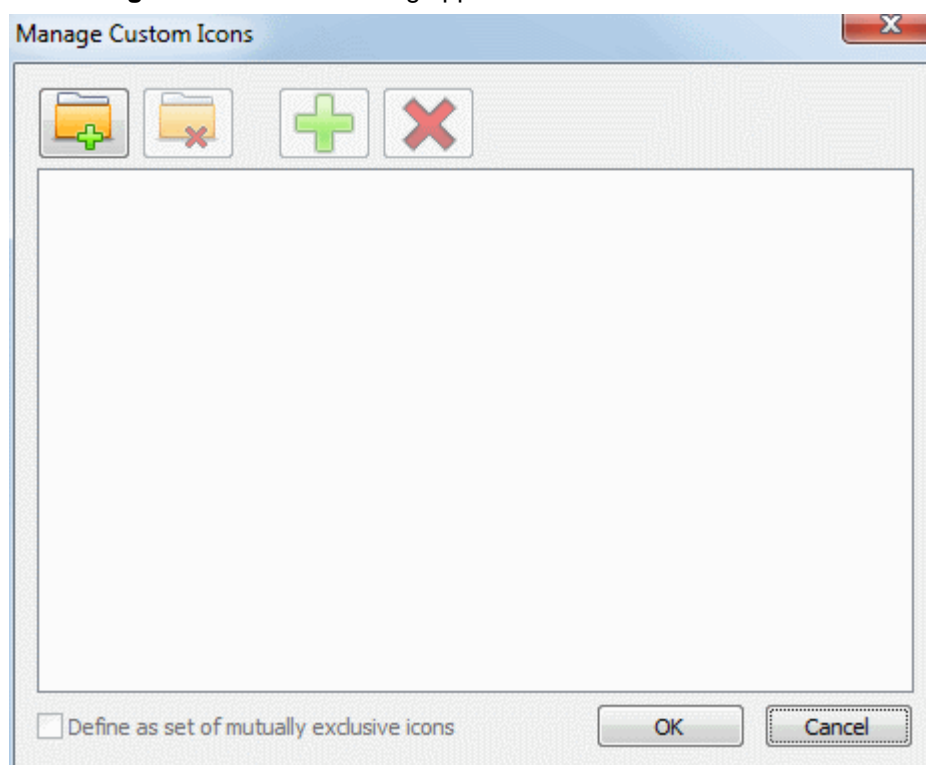
The **Manage Custom Icons** dialog appears.



- Click the **Create Set icon**  to create a new set of icons.
- (optional) If you want your new icon set to contain mutually exclusive icons (meaning that a particular branch can only contain one icon from the set), check **Define as set of mutually exclusive icons**.
- Click the **Add Icon icon**  to browse through your folders and select an icon to add to the set.
- (optional) To rename your custom icon, right-click it and choose **Rename**.

Your new set of icons now appears in the Icons gallery.



If you distribute to other users a mind map in which you have inserted custom icons, the other users will be able to view the custom icons as usual when they open the mind map on their computer. The custom icons are added to the bottom of the Icons gallery in a special set called "Other Icons".

## Inserting pictures

MindView lets you add pictures to the workspace itself, the root and any branch or sub-branch.

As all the research done in this area indicates that the use of pictures significantly enhances memory retention, you should try to use pictures wherever possible to illustrate your map.



Three different types of pictures are available:

- **Branch pictures** 

A branch picture "sits" on the root or branch to which it belongs. You can only add one branch picture to a particular root or branch.

It is considered good practice to insert a branch picture on the root to illustrate the subject of a map, as shown below.



- **Floating pictures** 

Unlike branch pictures, floating pictures can be moved wherever convenient on the workspace. Floating pictures can be connected to the root or particular branches, or just "float" freely on the workspace.

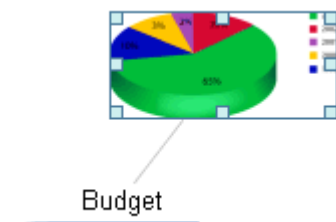

- **Attached picture files** 

MindView also allows you to attach various objects to the root and branches of your map, such as text files, picture files, video files, Flash files and so on. Not only can you activate these objects from within MindView, but you can also choose to include them when exporting your map to a different format, such as HTML or Mediator. See "[Attaching objects](#)" for more information on attached picture files.

## Inserting a picture

### Inserting a branch picture on a root or branch

- Select the root or branch to which you want to add a branch picture and choose **Insert | Pictures | Branch Picture** in the main menu or **Insert | Branch Picture** in the local menu.



You can also choose **Home | Insert | Branch Picture** in the main menu.

- Choose the picture required in the Open dialog.

The picture is now inserted by the root or branch label, at a position determined by the style applied to the map.



*You can also paste a branch picture from the clipboard: select the root or branch, then choose **Paste** or press **Ctrl + V**.*

- (optional) Resize the picture as necessary: first click the picture itself to select it, then move the mouse pointer on the required edge until it changes to a double arrow and drag with the mouse until the picture reaches the correct size.

If necessary, you can reset the picture to its original size by using its aspect ratio property. See "Picture properties" below.

You can also change the position of the branch picture with respect to the branch label, so that instead of being shown above the branch label for example, the picture is shown on its right or on its left:

- Click the branch picture to select it, then drag it over the branch label, using the preview shown in the bounding area to determine its new position. Drop the picture in one of the blue areas on the right or on the left of the branch label to position it accordingly.

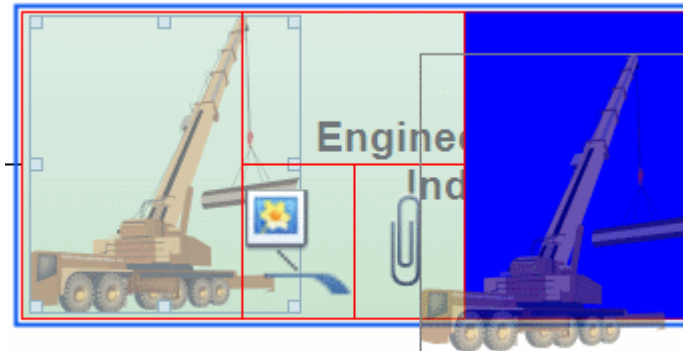

Dropping the picture in the left part of the blue area shown below the branch label converts it to a floating picture.

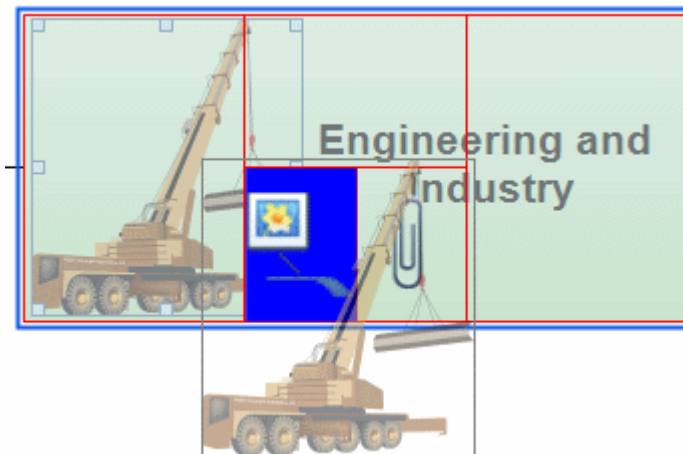

Dropping the picture in the right part of the blue area shown below the branch label converts it to an attached picture file.

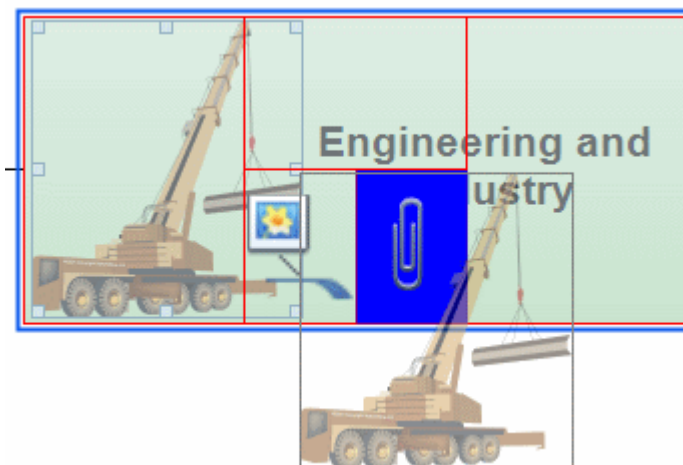

You can also use this method to drag the branch picture to a different branch.

### Inserting a floating picture on a root or branch

- Select the root or branch to which you want to add a floating picture and choose **Insert | Pictures | Floating Picture** in the main menu or **Insert | Floating Picture** in the local menu.
- Choose the picture required in the Open dialog.

The picture appears on the screen, scaled down from its original size if necessary.

- (optional) You can resize the picture as described above. You can also move the picture to a more convenient place by dragging it with the mouse or by using the arrow keys of the keyboard.

A thin line now connects your new picture with the root or branch you attached it to.

### Inserting a floating picture on the workspace

- Click the workspace and choose **Insert | Pictures | Floating Picture** in the main menu or **Insert | Floating Picture** in the local menu.
- Choose the picture required in the Open dialog.

When you add a floating picture to the workspace in this way, the picture is not attached to anything and no connecting line is visible.

- (optional) As above, you can resize or move the picture as necessary. You can even connect it to a particular branch by moving it on top of the branch.

### Dragging a picture

Instead of using the MindView commands described above, you can also add a picture by dragging it from the Multimedia Catalog, Windows Explorer or the Windows Desktop.



For a full description of the Multimedia Catalog, see "[Using the Multimedia Catalog](#)".

### Dragging a picture on a root or branch

- Just drag the picture from the Multimedia Catalog, from Windows Explorer or from the Windows Desktop and drop it on the relevant root or branch when it becomes highlighted.

By default, this creates a branch picture. If necessary, you can convert this branch picture to a floating picture by right-clicking the branch picture and choosing **Detach | Branch Picture** in its local menu.

### Dragging a picture on the workspace

- Just drag the picture from the Multimedia Catalog, from Windows Explorer or from the Windows Desktop and drop it on the workspace at the required position.

### Moving a picture

If necessary, you can easily move a picture from one branch to another branch:

- To move a branch picture to another branch, click the branch picture to select it, drag it to the other branch, and drop it in one of the blue areas of the preview bounding area described above, on the left, on the right or above the branch label.

You can also convert the branch picture to a floating picture by dropping it in the left part of the blue area shown below the branch label, or convert it to an attached picture file by dropping it in the right part of the blue area shown below the branch label.

Dragging a branch picture away from its branch and dropping it on an empty area of the workspace will create a freely floating picture not belonging to any of the branches.

- To move a floating picture from one branch to another branch, click the floating picture to select it, drag it to the other branch until the pointer changes shape, and drop it in the left part of the blue area shown below the branch label.

You can also convert the floating picture to a branch picture by dropping it in one of the blue areas on the left, on the right or above the branch label, or convert it to an attached picture file by dropping it in the right part of the blue area shown below the branch label.

## Detaching a picture

### Detaching a branch picture

- To detach a branch picture and convert it to a floating picture, select the branch to which it belongs and choose **Detach | Branch Picture** in its local menu.

### Detaching a floating picture

- To detach a floating picture from a root or branch, select the picture and choose **Detach** in its local menu.

The picture now belongs to the workspace itself rather than to the root or any of its branches.

## Replacing a picture

### Replacing a branch picture

You can replace a branch picture by another picture as follows:

- Select the branch to which the picture belongs.
- Press the **Ctrl** key while double-clicking the branch picture.

The Open dialog appears, letting you choose a different picture.

### Replacing a floating picture

- Double-click the floating picture.

The Open dialog appears, letting you choose a different picture.

## Deleting a picture

### Deleting a branch picture

You can delete a branch picture in two ways:

- Start by selecting the branch to which the picture belongs, and then either:
  - Click the branch picture itself (resizing handles appear around it) and press **Delete**, or
  - Choose **Delete | Branch Picture** in the branch local menu.



*If you press the Delete key by mistake, the whole branch will be deleted. You can restore it by clicking Undo  in the Quick Access Toolbar or pressing Ctrl + Z.*

### Deleting a floating picture

To delete a floating picture, select it and do one of the following:

- Press **Delete**, or
- Choose **Home | Editing | Delete**  in the main menu, or
- Choose **Delete** in its local menu.

## Picture properties

Pictures have properties, which you can edit with the Properties dialog.

Branches containing branch pictures have an extra Picture tab in their Properties dialog containing the picture properties. See "[Branch properties: Picture tab](#)" for a detailed description of the properties applicable to branch pictures.

See "[Floating picture properties: General tab](#)" and "[Floating picture properties: Picture tab](#)" for a detailed description of the properties applicable to floating pictures.

See "[Using the Properties dialog](#)" for a general description of the Properties dialog.



If the Properties dialog is not visible, choose **View | Show/Hide | Properties** to open it.

## Inserting task data



MindView Business Edition lets you enter task and time-related information on any of the branches of your mind map in order to create different types of documents, such as timelines, task lists and project plans.

This topic explains how to enter task data on the branches of your document to create a simple task list or a project plan. For information about entering time data for a timeline, see "[Inserting timeline data](#)".

Although you can also enter task data directly in other views such as the Outline view (task lists and project plans) and the Gantt view (project plans only), the **Task/Timeline** panel described here allows you to enter task data on your branches while brainstorming your document in one of the standard Mind Mapping views.

## Building a task list

- Click the **Task/Timeline** tab on the right of the workspace or choose **View | Show/Hide | Task/Timeline Panel** to open the panel.
- Make sure the document type is set to **Task Management**.
- Select a branch for which you want to add task data.
- (optional) Enter a **Start date**.
- (optional) Enter an **End date**.
- (optional) Choose a **Priority** level.
- (optional) Choose a percentage value to indicate how far the task has progressed to **Completion**.
- (optional) Assign **Resources** to the task by typing their names separated by semi-colons. You can also click the Resources button to the right of the field to open the Task Resources dialog. See "[Assigning resources](#)" in the "Gantt view" chapter for details about using this dialog and information on how to create a global resources list.
- Repeat the procedure to add task data to other branches.

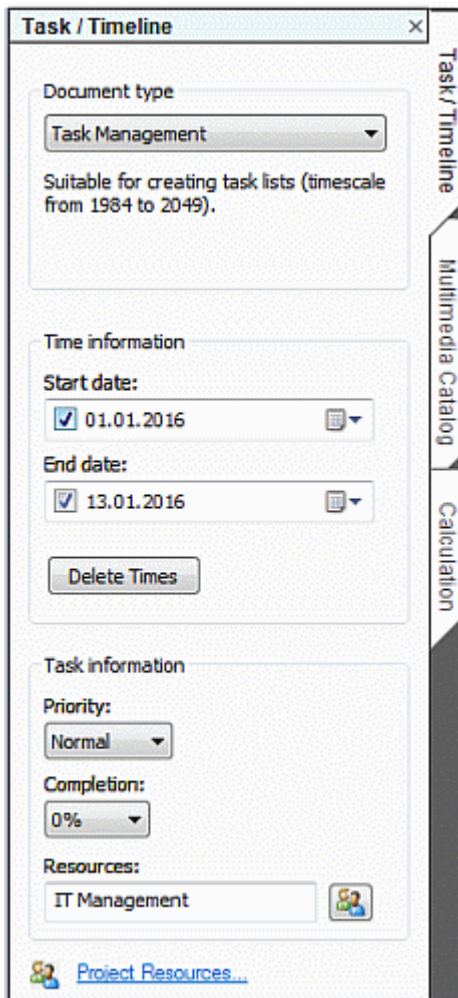

- (optional) To display, directly on the branches of the mind map, the task data you just entered, choose **View | Data | Show Branch Data**  (or right-click the workspace and choose **Show Branch Data**) and check the fields you want to see in the sub-menu.

 You can hide or show the fields on individual branches with the **Show Branch Data** icon of the **Format** tab (or the **Show Branch Data** option in the branch local menu).

It is also possible to format the task data displayed on the map in different ways. For more information, see "[Formatting a branch](#)".

You can delete the time information inserted on a branch at any time by selecting it and clicking the **Delete Times** button.

Once you have finished brainstorming your task list, you can display it in grid format in the Outline view for a better overview and faster editing. You can also obtain a chronological display of the tasks along a horizontal axis by switching to the Timeline view. See "[Using the Outline view](#)" and "[Using the Timeline view](#)" for more information on these two views.

You can also import an existing task list from Microsoft Outlook or export your task list to it, as well as synchronize different versions of the same task list stored in both programs.

For more information on the procedures involved, see "[Exporting to Microsoft Outlook](#)" and "[Importing from Microsoft Outlook](#)".

## Building a project plan

A project plan is a series of interdependent tasks that need to be performed in a particular order.

The MindView Gantt view, specific to the Business Edition, is dedicated to the creation, editing and management of project plans according to the rules of project management. It is the best view to use when working on a project plan, since it allows you to visualize immediately the consequences on the overall plan of any changes you make.

There are two important differences between the way in which MindView handles a simple task list and the way in which it handles a project plan:

- In a project plan, all parent branches become summary tasks. The start dates, end dates and durations of summary tasks are calculated automatically from their sub-tasks and cannot be edited.
- In a project plan, tasks are only scheduled during working time, as defined by the project and resources calendars.

For a full description of the Gantt view, including how to set up, create and manage a project plan, see "[Using the Gantt view](#)" and the topics that follow it in the "Gantt view" chapter.

The Task/Timeline panel described here gives you an alternative way of viewing and editing the information associated with the tasks of your project plan. It is useful if you want to brainstorm your project plan in one of the standard Mind Mapping views rather than using the Gantt view. Once you have finished brainstorming, switching to the Gantt view will enable you to take advantage of the full capabilities of the project management features offered by MindView.

- Click the **Task/Timeline** tab on the right of the workspace or choose **View | Show/Hide | Task/Timeline Panel** to open the panel.
- If you are creating a new project plan, make sure the document type is set to **Project Management**.
- Select a branch for which you want to add task data.
- (optional) Enter a **Duration**, using the drop-down list on the right to choose between different duration types (minutes, hours, days, weeks, months).

For detailed information about the different ways of entering a duration and how MindView uses this value to schedule tasks in a project plan, refer to the paragraph "[Entering a task duration](#)" in "[Entering and editing tasks](#)" (Gantt view).

Although you can add start dates and end dates to your project tasks, it is not recommended unless you understand the implications of doing so. It is normally better to let MindView calculate the start and end dates of the tasks automatically with reference to the project start date, the task durations, and the task links that you might have set up in the Gantt view. For detailed information about how MindView handles start and end dates in a project plan, refer to the paragraph "[Specifying start and end dates](#)" in "[Entering and editing tasks](#)" (Gantt view).

- (optional) Choose a **Priority** level.
- (optional) Choose a percentage value to indicate how far the task has progressed to **Completion**.
- (optional) Assign **Resources** to the task by typing their names separated by semi-colons.  
You can also click the Resources button to the right of the field to open the Task Resources dialog. See "[Assigning resources](#)" (Gantt view) for details about using this dialog and information on how to create a global resources list.
- Repeat the procedure to add task data to other branches.



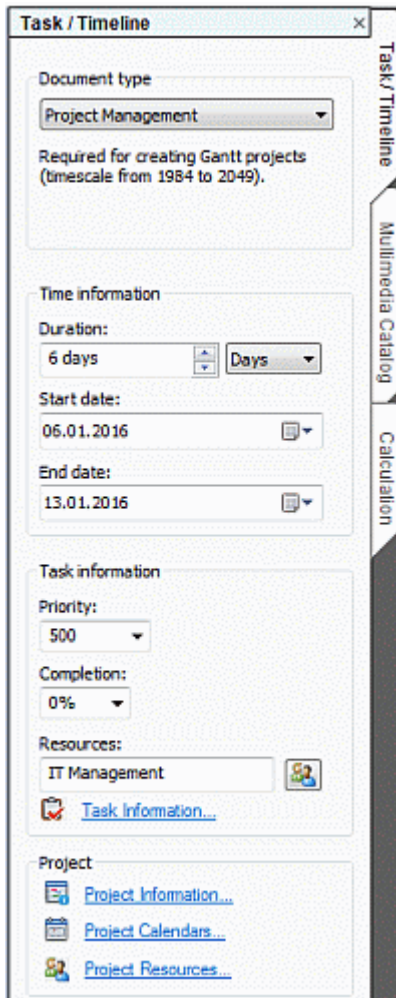

- (optional) To display, directly on the branches of the mind map, the task data you just entered, choose **View | Data | Show Branch Data**  (or right-click the workspace and choose **Show Branch Data**) and check the fields you want to see in the sub-menu.

 You can hide or show the fields on individual branches with the **Show Branch Data** icon of the **Format** tab (or the **Show Branch Data** option in the branch local menu).

It is also possible to format the task data displayed on the map in different ways. For more information, see "[Formatting a branch](#)".

MindView lets you export your project plans to Microsoft Project for further work. You can also import existing Microsoft Project plans into the Gantt view, directly from Microsoft Project or via the Microsoft Project XML format.

For more information on exporting and importing directly from Microsoft Project, see "[Exporting to Microsoft Project](#)" and "[Importing from Microsoft Project](#)". For the export and import options using the XML format, see "[Exporting to XML](#)" and "[Importing from XML](#)".

## Inserting timeline data

MindView Business Edition lets you enter time-related information on any of the branches of your mind map in order to create different types of documents, such as timelines, task lists and project plans.

This topic explains how to enter time information on the branches of your document in order to create a timeline.

For information about how to enter time information for a task list or a project plan, see "[Inserting task data](#)".



Entering time information on the branches of your document allows you to display these branches as chronological events along a horizontal axis in the Timeline view, as shown here:

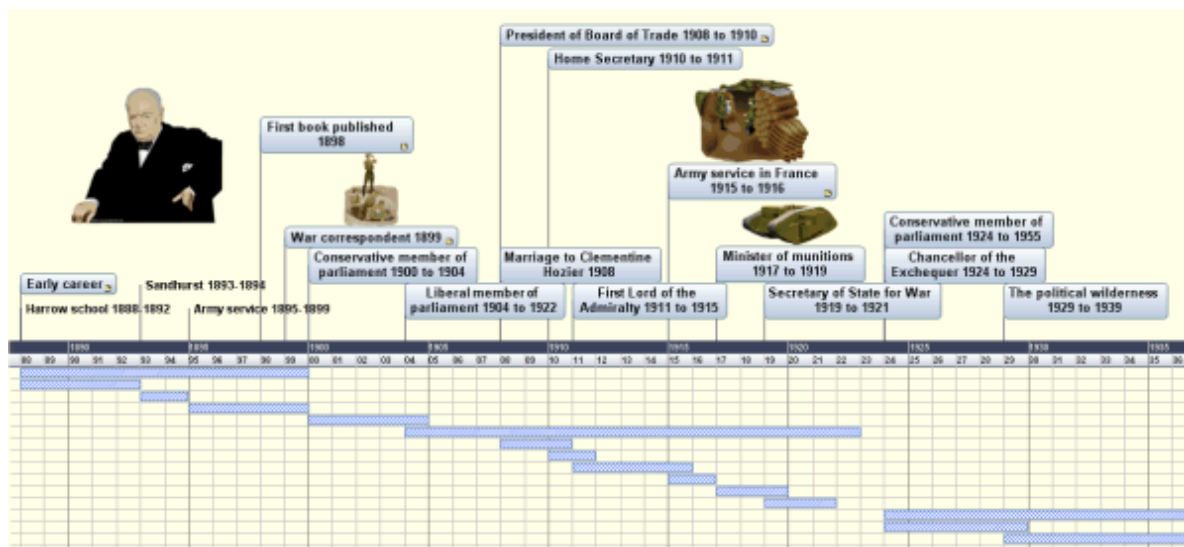

For a full description of the Timeline view, see the topic "[Using the Timeline view](#)". This topic also explains how you can present and export your timelines.

Although you can work directly in the Timeline view when creating a timeline, the **Task/Timeline** panel described here allows you to enter time information on your branches while brainstorming your document in one of the standard Map views.

## Choosing a timescale

Regardless of whether you are working in one of the Map views or in the Timeline view, the first thing you need to do when you are creating a timeline is to define the timescale of your document.

- Click the **Task/Timeline** tab on the right of the workspace or choose **View | Show/Hide | Task/Timeline Panel** to open the panel.
- Choose the document type **Timeline** in the first field.
- Select a **timescale** for the document. The default timescale is Standard.

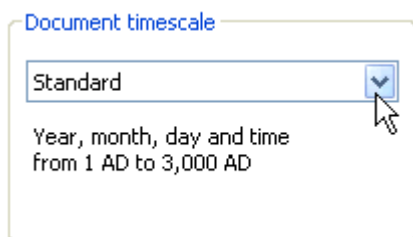

MindView lets you choose between several timescales to cater for different timeline projects:

**Standard:** Use this timescale for normal dates and times. It is also suitable for historical times where you do not need to show BC dates. You can specify the year, month, day and time. The range is 1 AD to 3,000 AD.

**Historic:** Use this timescale for historical dates. You can specify the year (BC or AD), month and day (not the time). The range is 5,000,000 BC to 3,000 AD.

**Geological:** Use this for plotting astronomical, geological or prehistoric events. You can specify dates in thousands or millions of years. Decimal numbers are allowed. The range is  $\pm 20,000,000,000$ .

**Daily:** Use this timescale to plot time by day number, without reference to specific dates or days of the week. For example, you could use it to chart the life cycle of an insect or to map out a process. You can specify day number and time: Day 1 is the first day, Day 17 the seventeenth, Day -3 the third day before the first day, and so on. The range is  $\pm 1,000,000$ .

**Weekly:** Use this timescale to plot time by week number, without reference to specific dates. You can specify week number, day (Monday to Sunday) and time. The range is  $\pm 100,000$ .

 *It is worth taking trouble to choose the timescale that is most appropriate for your subject. If you change the timescale later, you will have to re-enter the time information on all the branches.*

## Entering dates and times

- Select a branch for which you want to add time information.
- Click the button at the right of the **Start time** field in the **Task/Timeline** panel (or press **F12**).

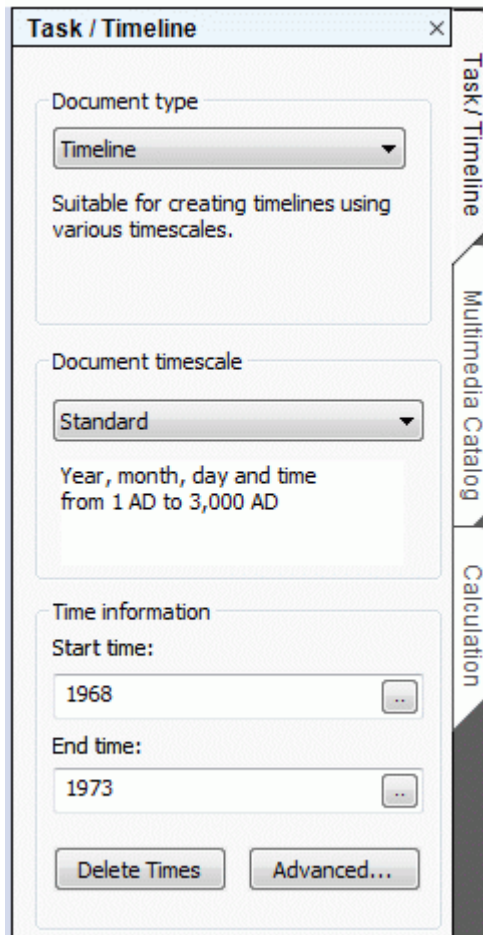

- Specify a **Start time** for the event in the dialog that opens. You do not have to make selections in all the boxes. For example, if you are using the Standard timescale, you can choose just a year, or just a year and month, without specifying an exact date or time.

If you make a mistake or enter a date that in hindsight is too specific for your needs, you can click **Reset** one or more times to undo your choices one by one. If for instance, you specify a date by selecting '2001', 'January' and '22', clicking Reset will remove the information about the day to leave the date as 'January 2001'.

Alternatively, you can just type in the date and time directly in the **Start time** field. You can use various shortcuts and abbreviations, depending on the timescale.

MindView interprets what you type and shows the results in pop-ups as you type: at any time you can click one of these to select it.

Here are some examples (displayed dates will depend on your machine's settings and so may be different from those shown here):

**Standard:**

'12 25 11', '12/25/11', '12-25-11' and '122511' all become Dec 25, 2011 (US settings);

'25 12 11', '25/12/11', '25-12-11' and '251211' all become 25 Dec 2011 (UK settings);

'3 3' becomes 3 Mar of the current year;

You can also specify a time after the date, separating the date and the time with a space. For instance, '2:00 pm' becomes 14:00.

**Historic:** '1211' becomes 1211 AD; '-490' becomes 490 BC;

**Geological:** '100m' becomes 100,000,000; '-5000' becomes -5,000 (i.e. 5,000 years ago); '50t' becomes 50,000.

**Daily:** '20' becomes Day 20; '-20' becomes Day -20; '2 10:pm' becomes Day 2, 22:00.

**Weekly:** '3' becomes Week 3; '3.0' becomes Week 3, Monday; '-2.6 3:' becomes Week -2, Sunday, 3:00.

- Click OK.
- If necessary, you can specify an **End time** by clicking the End time field or pressing **Ctrl + F12**. You do not need to specify an end time if your event has no extended duration. For example, to enter the date of an event that happened on a particular day, all you need to do is to specify the date as the Start time.
- Repeat the procedure to add time information to other branches.
- (optional) To display the time information you just entered on the branches of the map, choose **View | Data | Show Branch Data**  (or right-click the workspace and choose **Show Branch Data**) and check **Start/End time** in the sub-menu.



*You can hide or show the time information on individual branches with the **Show Branch Data** icon of the Format tab (or the **Show Branch Data** option in the branch local menu).*

It is also possible to format the time information shown on the map in different ways. For more information, see "[Formatting a branch](#)".

You can delete the time information inserted on a branch at any time by selecting it and clicking the **Delete Times** button.



As well as using this panel, you can also enter time information on branches from the Outline view or from the Timeline Outline panel shown in the Timeline view. Just double-click the relevant Start Time or End Time cell and fill in the time picker as described above.

## Advanced options

The **End Times Definitions** dialog which opens when you click the Advanced button at the bottom of the panel allows you to specify the way MindView should handle end times. These settings are only relevant when viewing the document in the Timeline view.

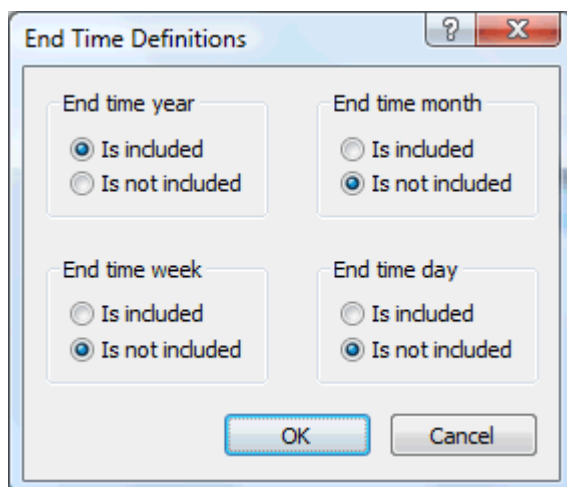

The simplest way to explain how this works is by means of an example. Suppose you are entering dates for a branch concerning World War II. As start date you specify 1939, so the branch displayed on the timeline will start at the beginning of 1939. As end date you enter 1945. There are now two possibilities:

- If the setting for **End time year** on this dialog is set to **Is included**, the end time will be the *end* of 1945. In other words the duration bar for the World War II branch will stretch from the beginning of 1939 to the end of 1945.

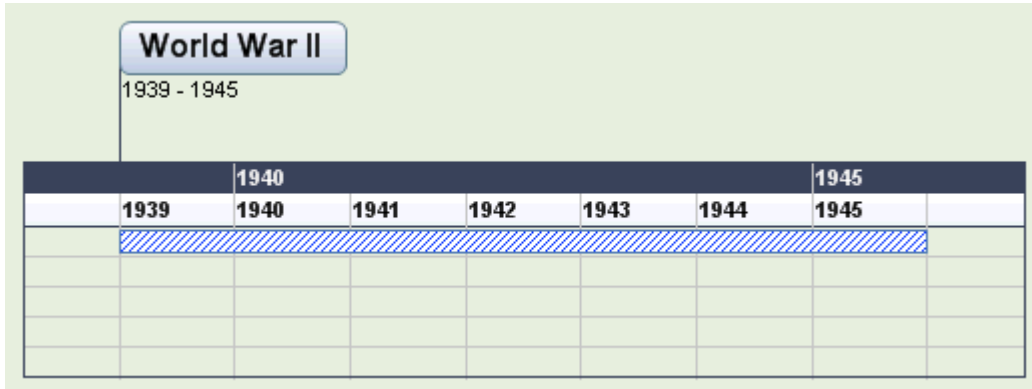

- If the setting for **End time year** on this dialog is set to **Is not included**, the end time will be the *beginning* of 1945. In other words the duration bar will stretch from the beginning of 1939 to the beginning of 1945.

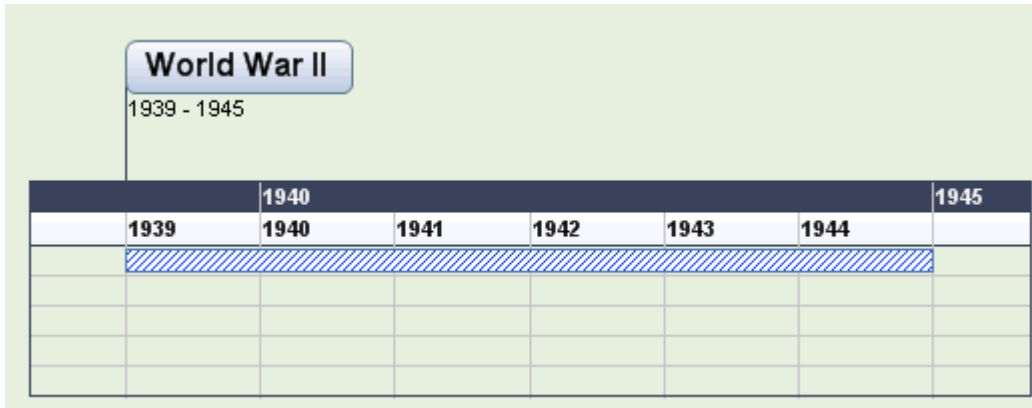

The settings for the other time periods, namely month, week and day, work in the same way.

**Important:** The choices you make in this dialog will apply *only* to the end times you insert from now on, and *only* for the current timeline. The next time you create a timeline, the settings of this dialog will revert to their default values. You are therefore free to choose different options for different timelines.

## Inserting calculation values



MindView Business Edition lets you enter numerical data on any of the branches of your mind map. This allows you to display values, such as sales numbers, costs, exchange rates and so on, and to enter calculations. Built-in functions allow you to display values automatically rolled up from lower sub-branches.

## Entering values on branches

To enter a value for, let us say, 'Units sold' on one or more branches:

- Select the branch(es).
- Click the **Calculation** tab on the right of the workspace or choose **View | Show/Hide | Calculation Panel** to open the panel.
- In the grid, click **<Insert New>** under **Name** and type "Units sold".

Name	Value
< Insert New >	

 If you have entered a value for 'Units sold' on the mind map before, you can skip this step as the 'Units sold' field will already exist.

- In the **Value** column enter the value, for example 2500.

Name	Value
Units sold	2,500.00
< Insert New >	

The value now appears below the branch on your mind map, and the 'Units sold' field (called a 'calculation field') becomes available for use in other branches.

Canada
Units sold: 2,500

 Calculation fields do not display on the mind map if they are empty. So, if a calculation field is created but no value is assigned (for example, if you omitted the final step in the above procedure), it will be available for use but not displayed anywhere. When you give it a value for a branch (other than zero) it will display on that branch.

Values you add directly on branches will override any default values you may have entered (see "Entering defaults" below). If you enter a branch value by mistake you can type **Ctrl + Z** to undo your entry, or right-click the value and choose **Reset to Default**.

 *Rather than adding values (or formulas) branch by branch, it is often quicker to add them using the Defaults and Formats dialog instead. See "Entering defaults" below.*

## Editing values

To edit values on one or more branches:

- Click the **Calculation** tab to open the Calculation panel.
- Select the branch(es).
- On the Calculation panel, make the changes in the **Value** column. Any changes you make will overwrite existing values on all of the selected branch(es).

## Entering defaults

To save unnecessary typing it is often useful to enter defaults for calculation fields. To do this:

- Click the **Calculation** tab to open the Calculation panel.
- Click **Defaults** to open the **Defaults and Formats** dialog.
- Enter values or formulas (see the next section) in the appropriate rows of the **Default Value** column.

The values or formulas you enter here will always be used unless you override them by making different entries for specific branches on the Calculation panel, as described above.

A blank entry means that there is no default. For calculation purposes the value of a blank entry is taken to be zero. An entry explicitly set to zero is not regarded as blank but as a default set to zero.

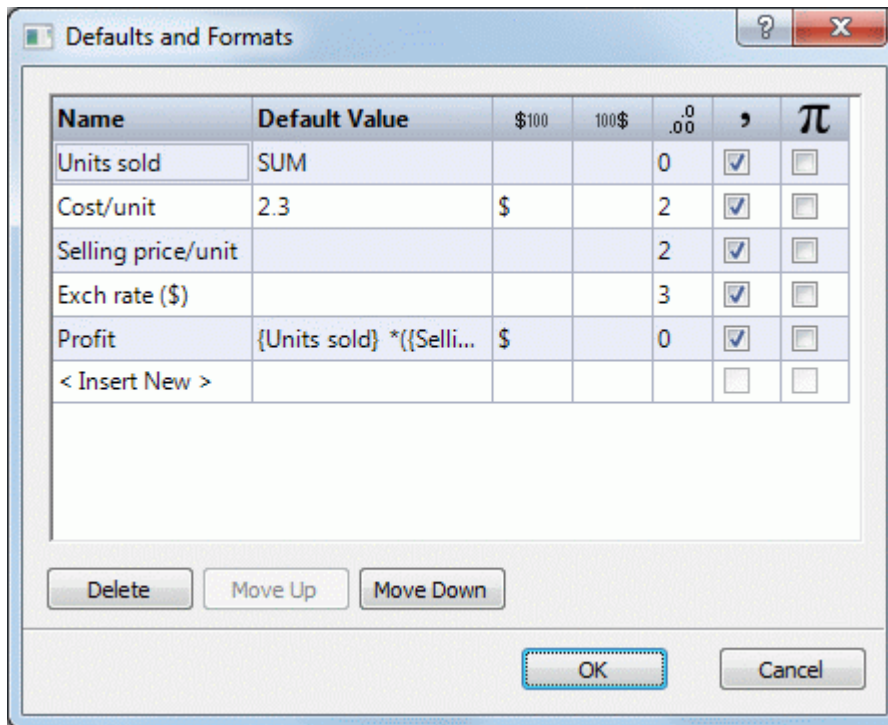

For each calculation field, you can also specify one or more of the following:

- In the \$<sup>100</sup> column enter text to precede the number, for example "\$" to indicate a dollar value.
- In the 100\$ column enter text to follow the number, for example " 000s" to indicate thousands.
- In the .<sup>0</sup>/<sub>00</sub> column enter a number to specify the number of decimal places to be displayed.
- In the , column, check the box to display thousands separators in large values.
- In the π column, check the box to specify that the calculation field should be treated as a constant value. Constant values are not displayed on the branches of the mind map, but can be used in calculations using formulas.

In the example below showing a stationery order, a constant called Delivery has been defined to cover a fixed delivery cost of \$10, to be added to the \$100 order cost. Using a constant in this way makes it much easier to update the map if the supplier increases the delivery cost in the future.

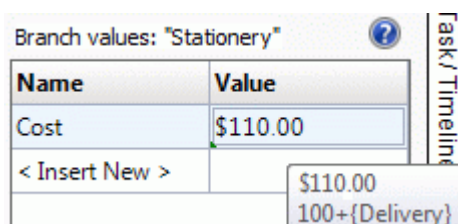

You can add a new calculation field to the mind map by entering its name in <Insert New>, or delete an existing field by selecting it and clicking **Delete**.

You can change the order in which the values display on the mind map, by moving the calculation fields up or down in this list by selecting them and clicking the **Move Up** or **Move Down** button.

### Entering an automatic sum

You can use the built in function SUM to add up values entered on the outermost sub-branches, providing a grand total on the root and sub-totals on the intermediate branches. To do this for our 'Units sold' calculation field, proceed as follows:

- Click the **Calculation** tab to open the Calculation panel.
- Click **Defaults** to open the **Defaults and Formats** dialog.

If you haven't yet created 'Units sold', click **<Insert New>** and type "Units sold".

- Type **SUM** as the default value for 'Units sold'. Alternatively, you can click the sum symbol  $\Sigma$  at the right of the field.

The entry SUM is a simple formula comprising just one function. For more information about formulas see "Entering formulas" below.

- Click OK.

The result is shown below. Values entered for 'Units sold' in the outermost branches are progressively totaled to a grand total on the root branch.

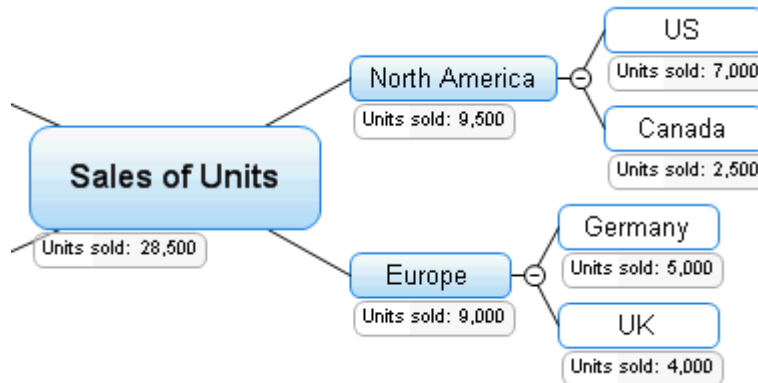

## Entering formulas

You can enter formulas directly on branches or as defaults. The procedures are the same as those described above, except that you enter a formula instead of a value.

You type the formula in the usual way, using values and any of the mathematical operators + - \* / ( ). In addition, the right-hand section of the **Function** icon  $\Sigma$  opens a drop-down list that lets you reference the other calculation fields on the branch. If you include any of these, the formula will use their current values at the relevant points in the calculation (if a field is blank its value is taken to be zero). Field names appear inside curly brackets in the formula.

```
{Units sold} * ({Selling price/unit} * {Exch rate ($) - {Cost/unit})}
```

The functions available when you click the **Function** icon  $\Sigma$  are divided into separate groups, as described below.

The functions in the **Sub-Branches** group automatically calculate a value based on values in the sub-branches:

- **SUM** gives the total created by adding the values, for this calculation field, from the sub-branches one level below the current one. It is useful for creating sub-totals throughout your mind map.



To enter SUM, the most commonly used function, you can simply click the sum symbol  $\Sigma$ .

- **AVG** gives the average of the values for this field from the sub-branches one level below the current one.
- **MIN** gives the minimum value for this field from the sub-branches one level below the current one.
- **MAX** gives the maximum value for this field from the sub-branches one level below the current one.
- **COUNT** gives the number of sub-branches one level below the current one.

The functions in the **Project Management** group are all related to Gantt projects and are therefore only available when you are working in Project Management mode (i.e. when your document type is set to "Project Management" in the Task/Timeline panel). For more information about Gantt projects, see "[Using the Gantt view](#)", and in particular "[Assigning resources](#)".



- **COST** gives you the overall cost of the resources (human and material) that have been allocated to the current task (branch).
- **ACTUALCOST** gives you the cost incurred so far by the current task, on the basis of the overall resources cost and the percentage of completion of the task.
- **REMAININGCOST** is the difference between the overall resources cost and the actual cost.
- **WORK** gives you the overall amount of work to be performed on the current task by all its resources.
- **ACTUALWORK** gives you the amount of work performed so far, on the basis of the overall amount of work and the percentage of completion of the task.
- **REMAININGWORK** is the difference between the overall amount of work and the actual work.



The three work values are calculated and expressed in seconds.



*If you are viewing your Gantt project in one of the standard Mind Map views, you can display these values directly on the branches of the mind map as explained in "Showing or hiding" values below. You can also define the currency symbol and the number of decimal digits to be used. See "[Currency](#)" in the topic "[Setting up your preferences](#)".*

The functions in the **Math & Trig.** group calculate a value based on values or field references which you enter:

- **POWER(value,power)** returns the result of a value raised to a power. For example, POWER(6,2) returns the value 36 which is six squared.
- **SQRT(value)** returns the square root of a value. For example, SQRT(2) returns the value 1.41, the square root of two.
- **LN(value)** returns the natural logarithm (log to base e) of a value. For example LN(123.4) returns the value 4.82.
- **LOG(value)** returns the logarithm to base 10 of a value. For example LOG(123.4) returns the value 2.09.
- **ABS(value)** returns an absolute value, in other words a negative value becomes positive. For example, ABS({payment}) returns the value 200 if the value in the field {payment} is 200 or -200.
- **INT(value)** returns the whole number, or integer, part of a value. For example INT(3.9) returns the value 3.

The functions in the **Financial** group also calculate a value based on values or field references which you enter:

- **FV(rate,periods,payment)** returns the future value of a series of equal payments at constant interest rate. For example, FV(0.025,5,-120) gives 630.76, the result of saving \$120 annually for 5 years at an interest rate of 2.5%. Note that the payment figure (money out) is negative whereas the end result (money in) is positive.
- **PV(rate,periods,payment)** returns the amount you would need to invest today in order to match a series of future payments. For example, suppose you have the choice of receiving a life insurance payout of \$10,000 now or 10 annual payments of \$1,200 a year, which would be the better option, supposing the annual interest rate over the 10 years to be 4% (0.04)? The calculation PV(0.04,10,-1200) gives a result of \$9,733 which is the amount that would need to be invested today for 10 years in order to match the value of the 10 annual payments of \$1200, assuming 4% interest. In other words the lump sum of \$10,000 is better. Note that the payment figure (money out) is negative whereas the end result (money in) is positive.
- **EFFECT(rate,periods)** returns the effective yearly interest rate based on the nominal interest rate and the number of compounding periods in the year. For example, if you have a field called Rate that contains an interest rate of 0.05 (5%) and a field called Periods that contains 12, the number of compounding periods in the year, then EFFECT({Rate},{Periods}) returns 0.0511 (5.11%). In other words, an annual rate of 5% compounded monthly is equivalent to 5.11% if only a single annual interest payment is made. This function is the reverse of NOMINAL, below.



- **NOMINAL(rate,periods)** returns the annual nominal interest rate based on the effective interest rate and the number of compounding periods in the year. For example, **NOMINAL(0.0511,12)** returns 0.05. In other words a yearly return of 0.0511 (5.11%) is equivalent to 0.05 (5%) if compounding is done monthly. This function is the reverse of **EFFECT**, above.

In the Calculation panel, it is the *result* of the formula that is displayed in the Value column, not the formula itself. To edit or view the underlying formula, double-click to enter edit mode. On the mind map itself, the formula never displays, always the result.

If there is an error in a formula you will see the value **#NAN** or **#NULL!**:

- The value **#NAN** indicates a division by zero, which leads to an invalid result. Check the divisor(s) in the formula to ensure that they cannot become zero.
- The value **#NULL!** indicates that a value needed by the formula is missing. This can happen if you have deleted a calculation field referenced by the formula. If you have just deleted the field, you can restore it by pressing Ctrl + Z. To help identify missing fields, they are shown in black, rather than the usual green, in the formula. If you reinstate a previously deleted field, the error will disappear, but you may have to re-enter values for the field.

## Reviewing values

Current values are displayed directly on the mind map.

The **Calculation** panel shows further information about the values on a selected branch:

- A difference marker at the bottom left of a calculation field alerts you that its value is different from its default. This is useful because it is easy, while developing a mind map, to mistakenly overwrite a default value by entering a value or formula directly on a branch.

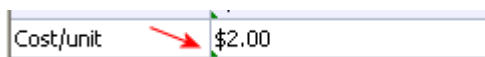

- The difference marker relies on there being a default for the value: if there is no default (in other words a blank entry on the Defaults and Formats dialog), the marker never appears.
- If you move the cursor over an entry in the Values column the hover text will show you the value and, if it is generated by a formula, the formula as well.

## Showing or hiding values

To display or hide calculation fields for the whole mind map:

- Click the **View** tab in the ribbon.
- Choose **Data | Show Branch Data**.
- Check (or uncheck) the calculation fields you want to show (or hide).

To display or hide calculation fields for a selected branch or branches:

- Select the branch(es).
- Click the **Format** tab in the ribbon.
- Choose **Data | Show Branch Data**.
- Check (or uncheck) the calculation fields you want to show (or hide).

It is also possible to format the calculation values displayed on the map in different ways. For more information, see "[Formatting a branch](#)".

## Example

Here is an example of part of a mind map that uses calculation fields.

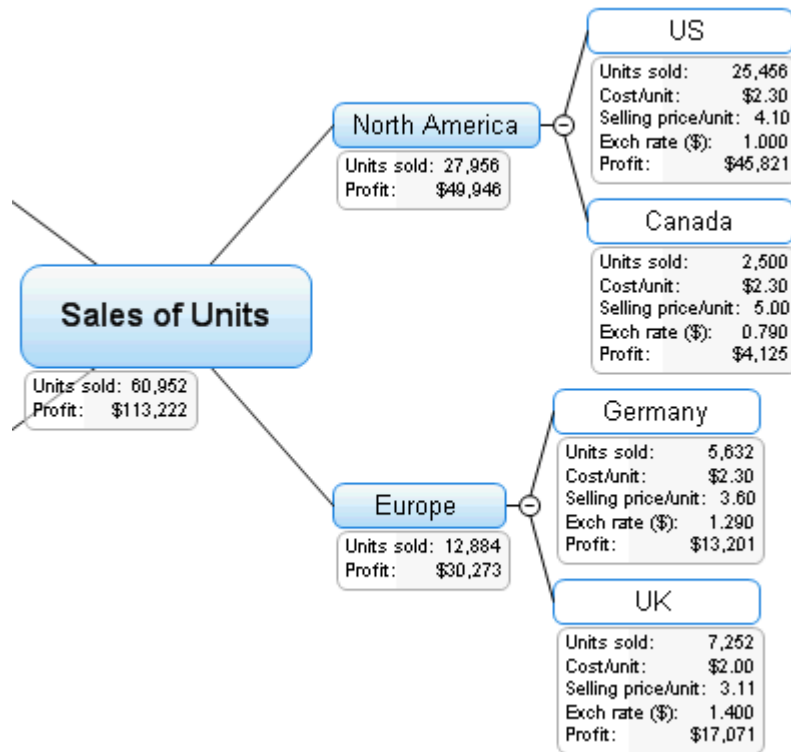

The calculation fields are:

- **Units sold** For the outermost sub-branches, values are added branch by branch. A default value of SUM creates subtotals for the remaining branches and a grand total for the root.
- **Cost/unit** This is the cost of each unit in dollars: it is displayed only on the outermost sub-branches. In most cases the value is \$2.30, so this is entered as a default. A different value has been entered directly on one of the branches. In such cases, and wherever a value is different from its default, you will see a difference marker in the Calculation panel, as here:

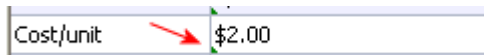

- **Selling price/unit** This the selling price of each unit in local currency: it is displayed only on the outermost sub-branches. It has no default value.
- **Exch rate (\$)** This the exchange rate that converts local currency into dollars: it is displayed only on the outermost sub-branches. It has no default value.
- **Profit** On the outermost sub-branches this is calculated by a default formula. An overriding formula, SUM, is added to each of the remaining branches and the root to create subtotals and a grand total.

The default values and calculation field formats, accessed by clicking **Defaults** on the **Calculation** panel, are:

Name	Default Value	\$100	100\$	.00	,	π
Units sold	SUM			0	<input checked="" type="checkbox"/>	<input type="checkbox"/>
Cost/unit	2.3	\$		2	<input checked="" type="checkbox"/>	<input type="checkbox"/>
Selling price/unit				2	<input checked="" type="checkbox"/>	<input type="checkbox"/>
Exch rate (\$)				3	<input checked="" type="checkbox"/>	<input type="checkbox"/>
Profit	{Units sold} *{(Selli...	\$		0	<input checked="" type="checkbox"/>	<input type="checkbox"/>

### Using Quick Data

The **Quick Data** area is only useful when you select two or more branches. It shows you the results of common operations on the calculation field selected in the grid above for the selected branches.

- Select two or more branches.
- Select a calculation field in the grid at the top of the Calculation panel.
- View the results in the Quick Data area. **Sum** shows the total of the relevant values for the selected branches, **Avg** shows the average of the values, **Min** shows the minimum value, **Max** shows the maximum value, and **Count** shows the number of branches selected.

Quick Data: Profit

<b>Sum:</b>	\$113,222
<b>Avg:</b>	\$16,175
<b>Min:</b>	\$3,792
<b>Max:</b>	\$45,821
<b>Count:</b>	7

## Printing a mind map



To print your map:

- Click the **File** tab.
- Choose **Print**.



You can also press **Ctrl + P**.

This opens the Print Preview window, which shows you what your map will look like on paper.

The preview of the map immediately reflects the changes you make in this window, allowing you to experiment with the various settings.



The preview area always shows the map exactly as it is shown on the workspace. This means that if you have restricted the display of the map in some way, for instance by showing only 2 levels of branches, focusing on a particular branch or using an advanced filter, only the part of the map shown in the preview area (and the workspace) will be printed. See "[Viewing a mind map](#)", "[Focusing on a branch](#)" and "[Filtering a mind map](#)" to learn more about these display options.

## Customizing the printing

Apart from the usual print operations, the Print Preview window lets you choose settings to optimize the printing of your map.

**Fit to Page:** This resizes the map so that its entire contents fit on the single page or page spread chosen.

**Page Spread:** These options allow you to spread your map on several pages, which is useful for large maps. If for instance your map is quite wide (as may be the case in Top Down view), you can click **Increase Width** to add one or more pages horizontally, thereby ensuring that its entire contents will be easily legible. Similarly, if your map is quite tall, you can click **Increase Height** to add one or more pages vertically. Whenever you increase or decrease the page spread, the map is automatically resized to occupy all the space available.

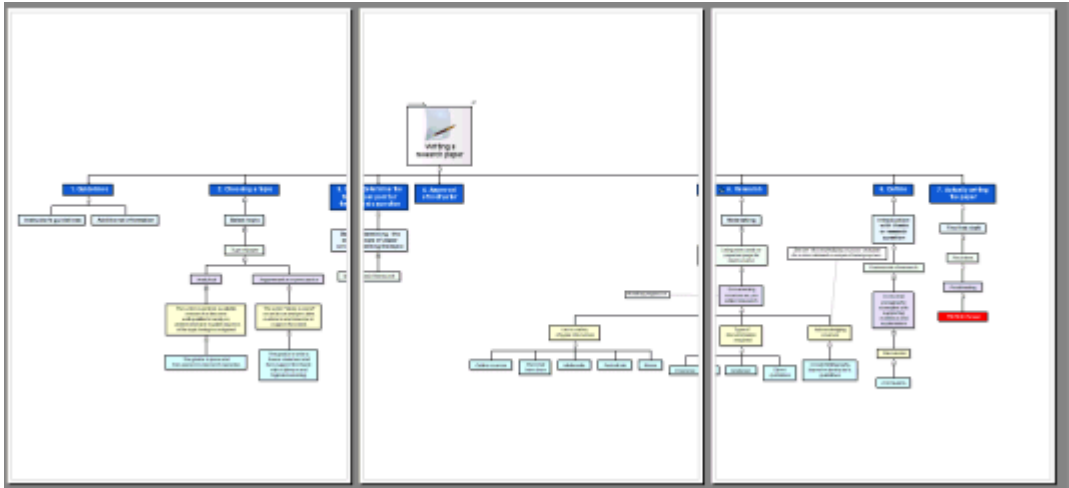

**Logo:** These options let you display a company logo or any other logo on the printed page or page spread, at the position defined by the placement icons shown on the right of the panel.

**Document Info:** These options let you display information about the document on the printed page or page spread, such as its title, its author and the current date, at the position defined by the placement icons shown on the right of the panel.

You can customize this information as follows:

- Click the down arrow on the right of the **Properties** field to choose the data you want to display.

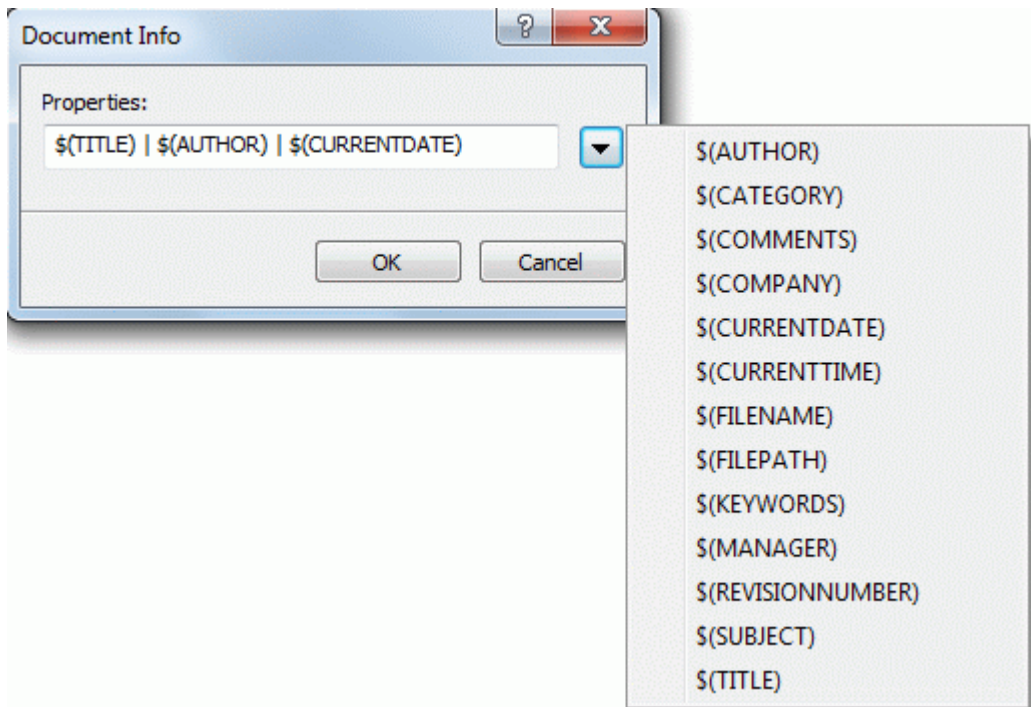

Each new piece of information is added to the right of the string. You can however rearrange the properties as you wish, and even enter your own free text to separate them. Note that most of the properties are taken from the data shown in the **Document Properties** dialog (click the **File** tab and choose **Prepare | Properties**).

### Moving or resizing the map

When moving the mouse pointer over the map in the Preview area, a red outline appears around it. You can move the map within the page or page spread by dragging the outlined area with the mouse.

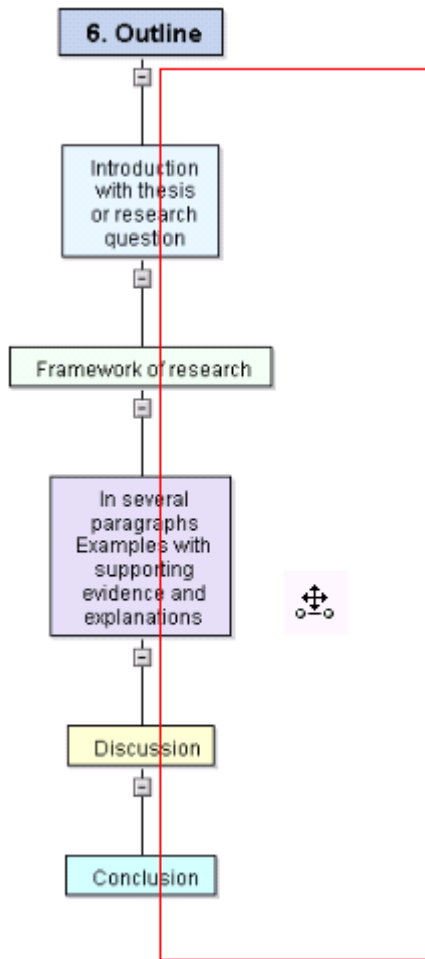

You can also resize the map within the page or page spread by moving the mouse pointer to one of its edges until it becomes a double arrow (the red outline becomes a blue outline), and dragging the edge in the direction required.

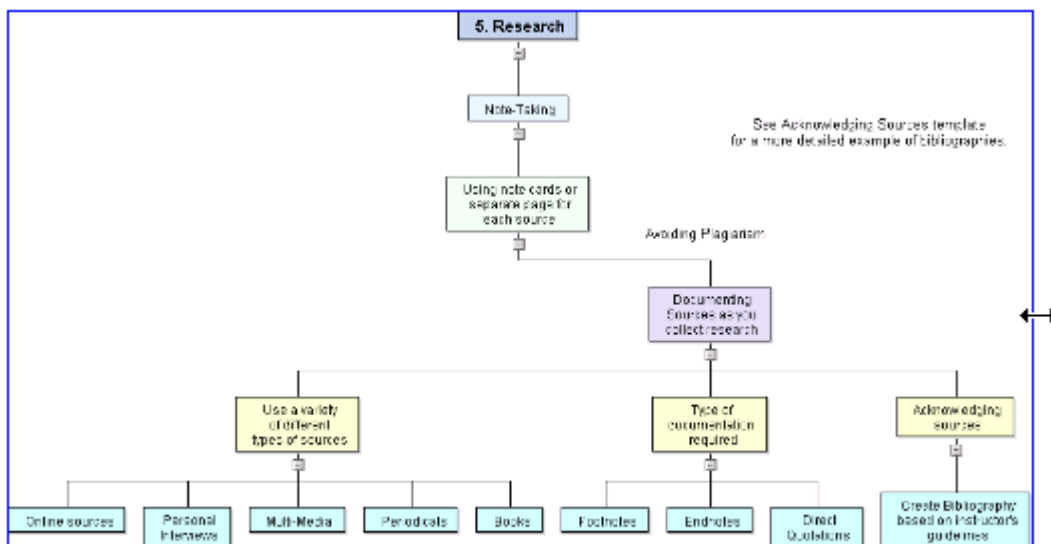

## Further tasks

### Formatting a branch

MindView lets you perform various operations on the root of your map or any of its branches, such as changing their shape, choosing a different fill color, defining a branch boundary, or selecting different text attributes. All these formatting options help you add visual interest to your map.

- Select the root or branch you want to format.



To apply the same formatting attributes to all the branches, it is much easier to use the **Design** tab, whose predefined styles and design options apply to the entire map. See "[Designing a mind map](#)" for more information.

You can however select several branches to give them the same formatting attributes. See "Selecting several branches" below for more information.

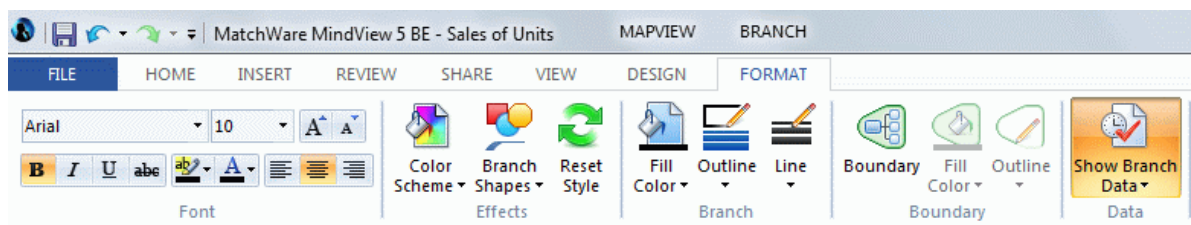

- Click the **Format** tab that appears at the right of the ribbon.

This tab contains formatting options applicable to the selected root or branch.



- Browse through the options available in the different panels, checking their effect on your branches as you go.



A quick way of copying the formatting attributes from one branch to another is to use the **Format Painter** . Select the branch whose formatting you want to copy and choose **Home | Clipboard | Format Painter** or press **Ctrl + Shift + C**. The cursor changes to a paintbrush icon . Click the branch you want to copy the formatting to. Pressing **Ctrl** while clicking the branch will let you continue copying the format to other branches by clicking each one in turn. To return the icon to its normal shape after the copying, click the **Format Painter** icon again.

If necessary, you can undo your changes and return the branch to the original map style defined in the **Design** tab by choosing **Effects | Reset Style**.



To return all the branches to the initial style, select them all (**Ctrl + A**), and choose **Effects | Reset Style** in the **Format** tab.



To return the entire map to the initial style (i.e. not only the branches, but also the global map properties such as page color or page pattern), choose **Effects | Reset Style** in the **Design** tab.

### Selecting several branches

Selecting several branches at once allows you to apply the same change to all of them simultaneously.

- Click the first branch, then press and hold down the **Ctrl** key while clicking the other branches one by one.

Each of the branches you click becomes highlighted to indicate that it is selected.

- To deselect one or more branches simply click them again while holding down the **Ctrl** key.

You can also select several branches by drawing a frame around them with the mouse. All the branches contained within the frame become selected.

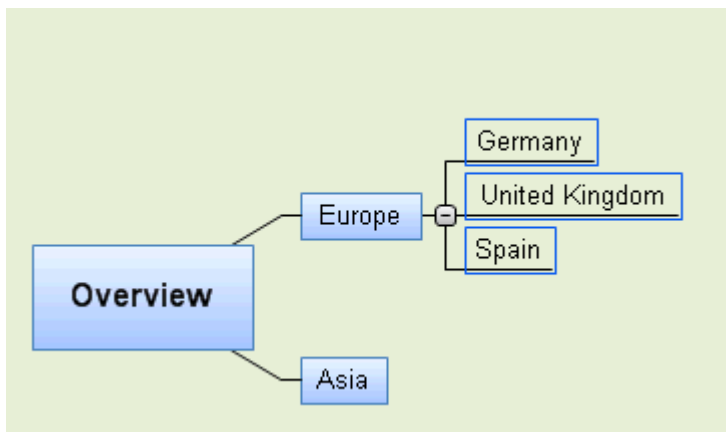
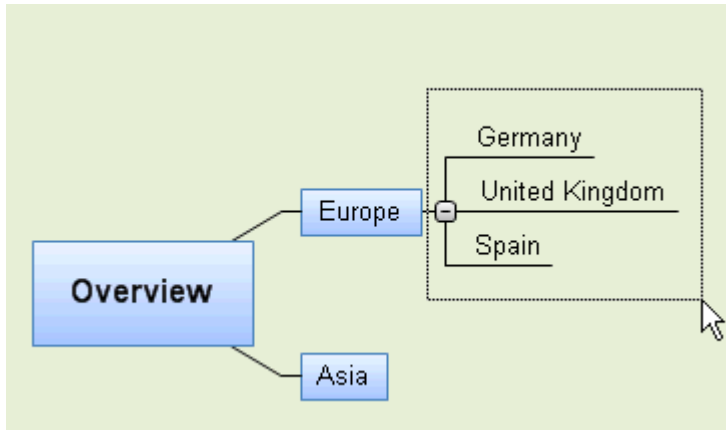

Press **Ctrl + A** to select all branches.



When you select several branches in this way, the header of the Format tab changes to **Multiple Branches**, indicating that any changes you make will apply to all the selected branches. If the branches you selected belong to different levels (for instance, some main branches as well as some sub-branches), only the options that the different levels have in common are shown in the Format tab.

## Formatting branch data

If you have added information on your branches such as task data or calculation values, you can display this data directly on the branches:

- Choose **View | Data | Show Branch Data**  (or right-click the workspace and choose **Show Branch Data**) and check the fields you want to see in the sub-menu.



You can hide or show the fields on individual branches with the **Show Branch Data** icon of the Format tab (or the **Show Branch Data** option in the branch local menu).

If you have chosen to display resource cost information on the branches (such as Cost, Actual Cost or Remaining Cost), you can define the currency symbol and the number of decimal digits to be used for the entire document. See "[Currency](#)" in the topic "[Setting up your preferences](#)".

You can also specify how this data should be represented.



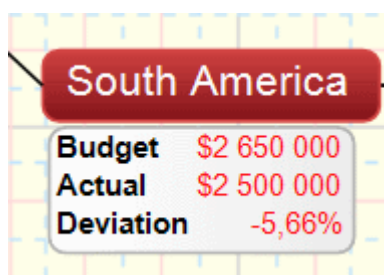

<b>South America</b>	
<b>Budget</b>	\$2 650 000
<b>Actual</b>	\$2 500 000
<b>Deviation</b>	-5,66%

- Select the branch whose data you want to format by clicking it.
- Click the block of branch data displayed below the branch.
- Click the **Format** tab that appears at the right of the ribbon.

This tab contains formatting options applicable to the branch data of the selected branch.

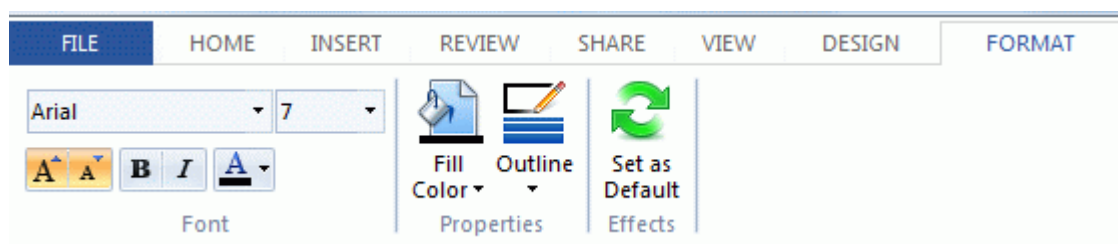

- Browse through the options available in the different panels, checking their effect on the branch data as you go.

You can also give specific text attributes to the different elements of the branch data. To do this, click the particular element within the block of branch data, and choose the required attributes in the Format tab.

 *Once you have formatted the branch data to your liking, you can easily apply that formatting to the data of all the other branches by clicking the **Set as Default** icon.*

## Branch properties

As well as the Format tab, you can also use the Properties dialog to make changes to the selected root or branch. The Properties dialog always lists all the properties applicable to the element currently selected in the workspace.

- Select the root or branch you want to format, or the block of branch data you want to format.
- Choose **View | Show/Hide | Properties** to open the **Properties** dialog.

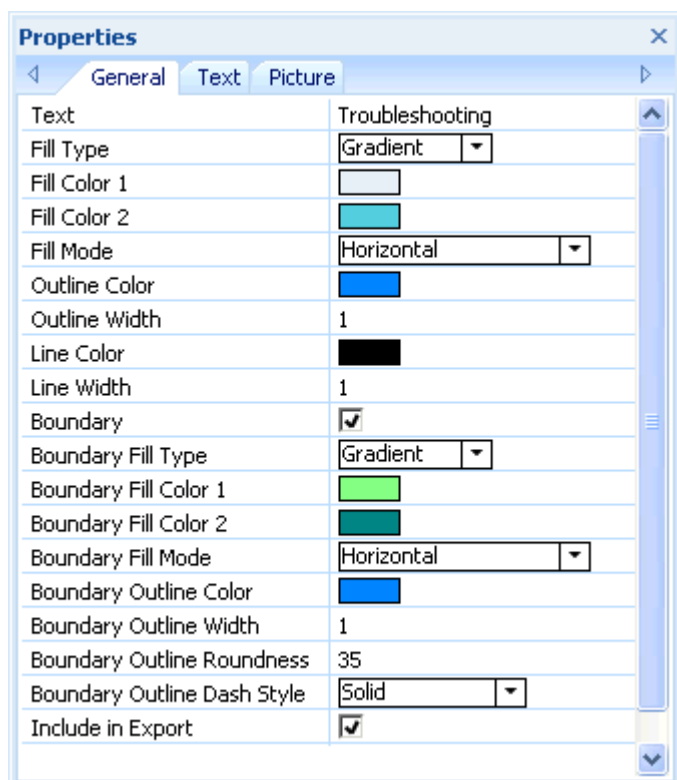

See "[Using the Properties dialog](#)" for a general description of the Properties dialog.

See "[Root properties: General tab](#)" and "[Branch properties: General tab](#)" in the Reference section for a detailed description of the general properties applicable to a root or branch.

See "[Root properties: Text tab](#)" and "[Branch properties: Text tab](#)" for a description of the properties applicable to the branch label.

See "[Branch data properties: General tab](#)" in the Reference section for a detailed description of the properties applicable to branch data.

## Moving a branch

As your map grows and you start analyzing its various topics, you may realize that some of them don't in fact belong to the branch you first allocated them to, but should be moved to a different branch.

This topic describes how to perform the following operations:

- Moving a main branch or a sub-branch and inserting it at a different hierarchical level in the mind map
- Cutting, copying and pasting a branch in the same document or in another document
- Moving a main branch manually to a different position by disabling the Auto-layout mode

### Moving a main branch or a sub-branch and inserting it at a different level

You can move an entire branch, including any sub-branches and objects attached to it, to a different branch of your map. As you work on organizing your ideas, you can for instance decide to convert a sub-topic to a main topic by moving the corresponding sub-branch to the root, or allocate a sub-topic to a different main topic by moving the corresponding sub-branch to a different main branch.

- Select the branch you want to move to a different location by clicking it with the left mouse button.
- While keeping the left mouse button down, drag the branch to the required location.  
The mouse pointer changes to a different shape and a line shows you where the branch will be inserted when you let go of the mouse button.

- Release the mouse button to insert the branch at the required location.

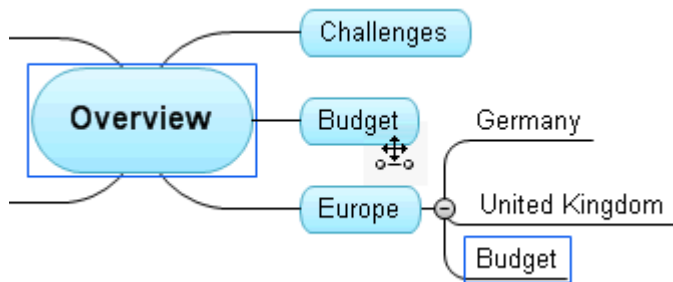



If you are viewing your map in the Mind Map or Left/Right views, you can also use the **Ctrl + Up** and **Ctrl + Down** keyboard shortcuts to move the currently selected branch up or down in the map. Similarly, the **Ctrl + Right** and **Ctrl + Left** keyboard shortcuts allow you to move a branch right or left in the Top Down view.

## Cutting, copying and pasting a branch

You can apply the standard Cut, Copy and Paste functions to any branch of your mind map. This allows you to copy or move an entire branch, including all its sub-branches and attached objects, to a different part of your map, at the same hierarchical level or at a higher or lower level, in the same document or in a different document.

You can also apply the Cut, Copy and Paste functions to the root itself. This allows you for instance to copy an entire map from one document and add it as a main branch or a sub-branch in a different document. This is a very useful feature if you need to consolidate several different documents into a master document, as described in "[Packing a mind map](#)".

- To cut a root or a branch with all its sub-branches and attached objects to the clipboard (in other words to place the root or branch on the clipboard while removing it from your map), you first need to select it. You can then either:
  - Choose **Home | Clipboard | Cut**  in the main menu, or
  - Choose **Cut** in the local menu of the branch, or
  - Press **Ctrl + X**.
- To copy a root or a branch and all its sub-branches and attached objects to the clipboard (in other words to place the root or branch on the clipboard while leaving it in place in your map), you first need to select it. You can then either:
  - Choose **Home | Clipboard | Copy**  in the main menu, or
  - Choose **Copy** in the local menu of the branch, or
  - Press **Ctrl + C**.
- To paste a root or a branch and all its sub-branches and attached objects, you first need to select its new location, either in the same document or in a different document. You can then either:
  - Choose **Home | Clipboard | Paste**  in the main menu, or
  - Choose **Paste** in the local menu of the destination branch, or
  - Press **Ctrl + V**.

The clipboard root or branch is added as a sub-branch of the destination branch you selected.



If you cut and paste a branch that is the starting point of a branch connection (see "[Creating branch connections](#)"), the branch connection will be moved with the branch. However if you cut and paste a branch that is the end point of a branch connection, the branch connection is not kept.

## Moving a main branch to a different position by disabling Auto-layout

By default, MindView automatically arranges the main branches as you insert them to prevent any overlap. You can however choose to reposition the main branches yourself after their insertion by disabling Auto-layout mode.

- Click the workspace so that no other element is selected.
- Choose **View | Show/Hide | Properties** to open the Properties dialog for the view.
- Click the **Branches** tab.
- Uncheck **Auto-layout**.

You can now position the main branches of your map as you wish by dragging them with the mouse.

Note that this only applies to main branches. MindView always arranges sub-branches automatically.

**Important:** If you re-enable Auto-layout mode at any point while still working on your map, the main branches you repositioned will be placed back in their default position. You can however click Undo  in the Quick Access Toolbar (or press Ctrl + Z) to cancel the re-enabling of Auto-layout and revert the display of the main branches to your own positioning.

## Focusing on a branch



As your map grows, you might find it useful to concentrate on a particular area by viewing only a chosen branch or set of branches. This also gives you more workspace to add comments, text notes, icons and other objects on the particular branch or set of branches you are viewing.

- Click the branch that you want to isolate.
- Choose **View | Detail | Apply Branch Focus**  in the main menu or **Apply Branch Focus** in its local menu.

You can also just press **F6**.

Now only the branch you selected is shown on the workspace, together with any sub-branches it may have.



To focus on one of the sub-branches, just select it and click **Apply Branch Focus** again.

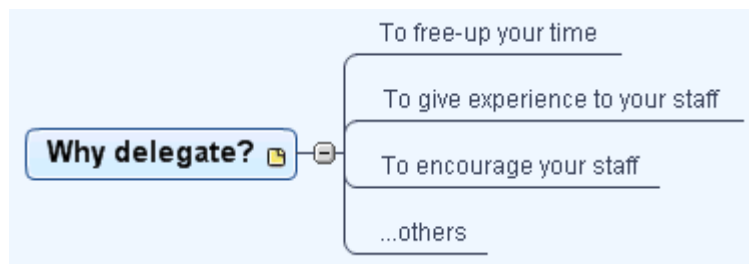

Note that when restricting the display in that way, any branch connections leading to branches outside the area shown are not represented.



To display the entire map again, you can either:

- Click the **Clear Branch Focus** icon  in the main menu, or
- Select the branch again and choose **Clear Branch Focus** in its local menu, or
- Right-click the workspace and choose **Clear Branch Focus** in its local menu, or
- Press **Ctrl + Shift + F6**.



If you save and close a document to which you have applied a branch focus to concentrate on a specific branch or set of branches, next time you open the document, a message warns you that you may be viewing only part of the map. Click the **Clear Branch Focus** button next to the message to see the entire map again.

 This document has a branch focus set. Clear Branch Focus

 You can also collapse the entire mind map to just one level of branches, two levels, three levels or four levels by using the **Detail Level** icons  of the View tab. The **All Levels** icon  expands the mind map so that it shows all its branches down to the last level.

 You can also press *Ctrl + 1* to display just one level of branches, *Ctrl + 2* to show two levels etc. *Ctrl + 5* shows all levels.

## Filtering a mind map

 MindView lets you filter your map to only display branches that meet specific criteria. Using a filter, you can for instance show only the branches that contain the word "budget", or, if you are working on a timeline, events starting at a given date. You can also combine different criteria, so that only the branches that meet all or some of these criteria are shown.

All the filters you define are saved with the MindView document. It is also possible to import and export filters for use in other MindView documents.

 If you save and close a document to which you have applied a filter to show only specific branches, next time you open the document, a message warns you that you may be viewing only part of the map. Click the **Clear Filter** button next to the message to see the entire map again.

 This document has a filter set. Clear Filter

## Defining a filter

- Choose **View | Filter** and click the down arrow at the bottom of the **Filter** icon.
- Choose **New**  in the sub-menu.

The **Filter** dialog opens.

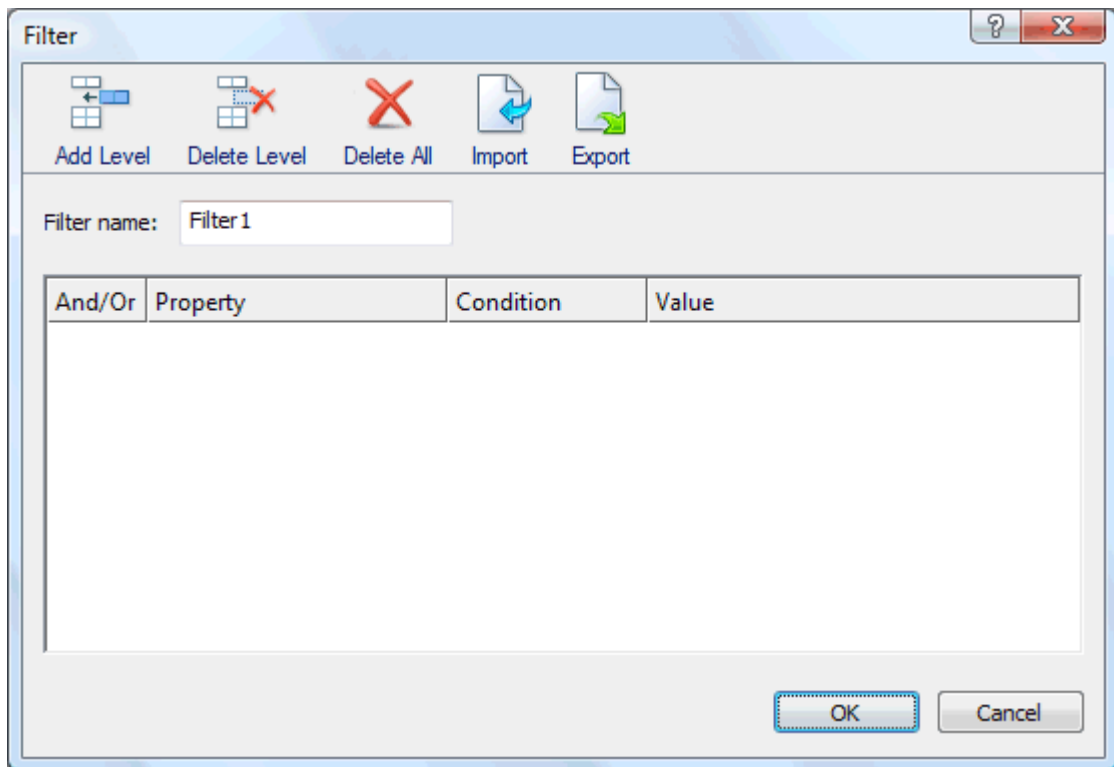

- Enter a name for your filter in the 'Filter name' field.

- Click **Add Level** to define your first condition.
- Click the **Property** field and choose the branch element that you want to use to filter the map. If for instance you want to restrict the display to all the branches on which you have placed a Priority 1 icon, select the entry "Branch icons" in the list.
- 💡 *For a definition of the property "Total slack", see "[Reviewing a project plan](#)".*
- Click the **Condition** field and choose the required condition. In our example, you would choose the entry "Equal to" or "Contains" (in case some branches contain more than one icon).
- Click the **Value** field to define the condition to be applied to the branch. In our example, you would choose the Priority 1 icon in the icon gallery that opens when you click the Value field.
- (optional) Click **Add Level** again to define a second condition, using the **And/Or** field to indicate whether both conditions must be met for the branch to display, or whether meeting just one of the two conditions is enough for the branch to display.
- (optional) Continue adding conditions as required and click OK.

The mind map now only shows the branches that meet the criteria you have defined.

The Filter icon stays highlighted to remind you that you are only viewing part of the map.

If necessary, you can add further criteria to the filter by editing it (see below) or define new filters.

### Clearing a filter

- To go back to the full map display, just choose **View | Filter | Filter** again to clear the filter.

The Filter icon goes back to its normal state, indicating that the map is no longer filtered.

### Applying a filter

When you have several filters, you can apply any one of them as follows:

- Choose **View | Filter** and click the down arrow at the bottom of the **Filter** icon.
- Click the required filter from the list shown at the bottom of the sub-menu.

### Editing a filter

- Choose **View | Filter** and click the down arrow at the bottom of the **Filter** icon.
- Choose **Edit**  in the sub-menu, select the filter you want to edit and proceed as described above.

### Deleting a filter

You can also delete a filter previously defined permanently from the MindView document if you no longer need it:

- Choose **View | Filter** and click the down arrow at the bottom of the **Filter** icon.
- Choose **Delete**  in the sub-menu and select the required filter.

## Attaching objects



One of the strengths of MindView is that it allows you to attach objects to the root or any branch or sub-branch of your mind map. This means that you can enhance your map with a variety of multimedia features, such as sounds, video sequences or Flash animations, as well as add all the relevant backing documents to each of your branches (e.g. Microsoft Excel spreadsheets, Microsoft Word documents, etc.)

Not only can you activate these objects from within MindView, but you can also choose to include them when exporting your map to a different format, such as a web site or a Microsoft PowerPoint presentation.

 Although MindView does not apply any restriction on the type of files it is possible to attach to a branch, you will only be able to open an attached file from the mind map if a program associated with its file type (e.g. bmp, doc, xls etc.) is installed on your computer.

 By default, when you attach a file to a branch in this way, it is added to the mind map as a link to the file stored on your hard disk. If you intend to distribute your mind map to others, you should first use the Pack feature to pack all the attached files into the mind map, thereby ensuring that your colleagues have access to all the files you are using. See "[Packing a mind map](#)" for more information. If you want to send your mind map by e-mail, you can use the Send feature to create this packed version automatically. See "[Sending a mind map](#)" for more information.

MindView also allows you to create a link between a branch and an external element such as a URL. See "[Creating hyperlinks](#)" for more information on links.

## Attaching an object to a root or branch

There are two ways of attaching an object:

- Select the required root or branch, choose **Home | Insert | Attachment** in the main menu or **Insert | Attachment** in the local menu, and select the object you want to add.
- Drag the required file from Windows Explorer and drop it on the root or branch.

 You can also attach a picture from the clipboard: select the root or branch, press and keep the **Shift** key down, and choose **Paste**.

As soon as you add an object to a root or branch, a paperclip icon  appears to the right of its label to indicate the presence of the attached object. Moving the mouse pointer over this paperclip icon displays a pop-up list of all the objects attached.

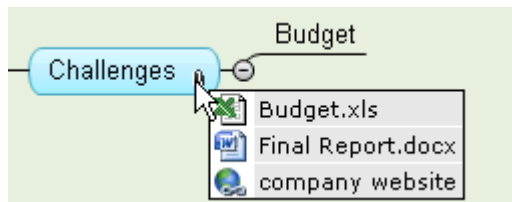

The attachment is also added to the Object list of the root or branch, giving you a complete overview of the objects you have attached to it.

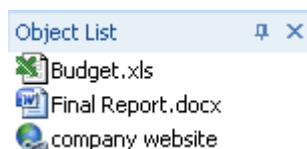

See "[Using the Object list](#)" for more information.

## Activating an object

Once attached, there are several ways to activate an object:

- **Double-click** the object in the Object list, or
- Select the object in the Object list and choose **Execute** in its local menu, or
- Display the object pop-up list by moving the mouse pointer over the paperclip icon  and click the object required.

These actions all activate the object, which opens in the viewer associated with its extension type. For instance, if the attached object is a Word document, it will open in Microsoft Word. If it is a video, it will open in the video playing software installed on your computer, and so on.

## Moving an object

You can easily move or copy an attached object from one branch to another.

- To move an object, select it in the Object list of the original branch and drag it to the branch you want to move it to.



- To copy an object, select it in the Object list of the original branch, press the Ctrl key and drag it to the branch you want to copy it to while keeping the Ctrl key down.

## Deleting an object

To delete an object, select it in the Object list and do one of the following:

- Press **Delete**, or
- Choose **Delete** in its local menu.



Remember that if you delete an attached object by accident, you can always cancel the deletion by clicking **Undo**  in the Quick Access Toolbar or pressing **Ctrl + Z**.

## Object properties

Objects have properties, which you can edit in the **Properties** dialog.

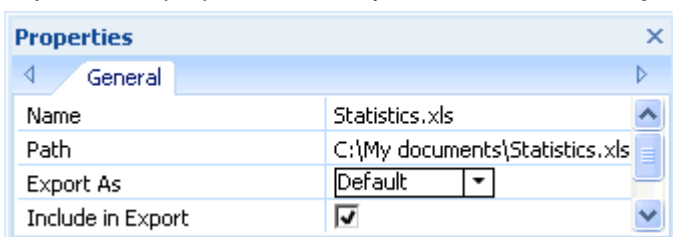

See "[Attachment properties: General tab](#)" for a detailed description of the properties applicable to objects and "[Using the Properties dialog](#)" for a general description of the Properties dialog.



If the Properties dialog is not visible, choose **View | Show/Hide | Properties** to open it.

## Inserting sounds



MindView lets you record sounds directly from within the program and add them to the branch or sub-branch of your choice.

- Select the root or branch to which you want to add a sound.
- Choose **Insert | Links | Sounds**.

The **Sound Recording** toolbar appears.



- Press the **Record** button to start recording.
- Press the **Play** button to playback and check your recording.
- When you are satisfied with your recording, press the **Save** button (on the right) to save it in the folder of your choice.

A paperclip icon  now appears to the right of the branch label to indicate the presence of an attached object. Moving the mouse pointer over this paperclip icon displays a pop-up list of all the objects attached.

The sound is also added to the Object list of the root or branch, giving you a complete overview of the objects you have attached to it.

See "[Using the Object list](#)" for more information.

## Playing a sound

Once attached, there are several ways to playback a sound:

- **Double-click** the sound in the Object list, or
- Select the sound in the Object list and choose **Execute** in its local menu, or

- Display the object pop-up list by moving the mouse pointer over the paperclip icon  and click the sound.

## Moving a sound

You can easily move or copy a sound from one branch to another.

- To move a sound, select it in the Object list of the original branch and drag it to the branch you want to move it to.
- To copy a sound, select it in the Object list of the original branch, press the Ctrl key and drag it to the branch you want to copy it to while keeping the Ctrl key down.

## Deleting a sound

To delete a sound, select it in the Object list and do one of the following:

- Press **Delete**, or
- Choose **Delete** in its local menu.



*Remember that if you delete a sound by accident, you can always cancel the deletion by clicking **Undo**  in the Quick Access Toolbar or pressing **Ctrl + Z**.*

## Sound properties

Like all objects, sounds have properties, which you can edit in the Properties dialog.

See "[Attachment properties: General tab](#)" for a detailed description of the properties applicable to sounds and "[Using the Properties dialog](#)" for a general description of the Properties dialog.



If the Properties dialog is not visible, choose **View | Show/Hide | Properties** to open it.

## Creating hyperlinks



The Hyperlink command lets you create a link between a branch and external elements, such as a URL, an external file or an email address. Once the hyperlink is inserted, activating it automatically opens the viewer associated with the linked element on your computer (such as browser, application or email program).

## Inserting a hyperlink on a root or branch

- Select the required root or branch and choose **Home | Insert | Hyperlink** in the main menu or **Insert | Hyperlink** in the local menu.

The **Hyperlink** dialog opens.

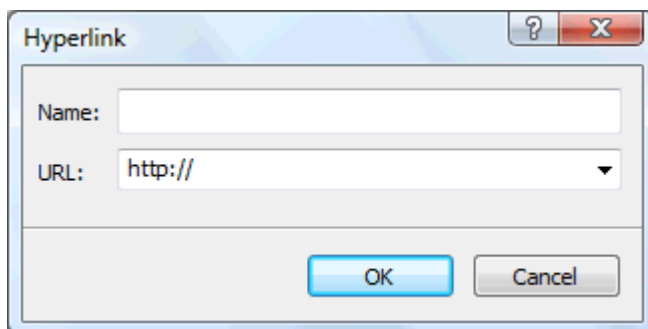

- Type a name for your hyperlink. If you export your map, this is the text that will make up the hyperlink.
- Enter the required URL. To enter other elements, click the down arrow at the right of the input field and choose the required prefix.



You can open this dialog again at any time to change its settings by choosing **Edit Link** in the hyperlink local menu.

 To insert a web page hyperlink onto a branch, just drag the link from the web page displayed in your Internet browser. The Hyperlink dialog is then automatically filled in with the URL of the link.

As soon as you add a hyperlink to a root or branch, a paperclip icon  appears to the right of its label to indicate the presence of the hyperlink. Moving the mouse pointer over this paperclip icon displays a pop-up list of all the objects attached.

The hyperlink is also added to the Object list of the root or branch, giving you a complete overview of the objects you have attached to it.

See "[Using the Object list](#)" for more information.

## Activating a hyperlink

There are several ways of activating a link from within MindView:

- **Double-click** the hyperlink in the Object list, or
- Select the hyperlink in the Object list and choose **Execute** in its local menu, or
- Display the object pop-up list by moving the pointer over the paperclip icon  and click the hyperlink.

These actions all activate the linked element:

- If your hyperlink contains a URL, the web page opens in your default browser.
- If your hyperlink contains a path to a file, the application associated with the file type on your computer opens and displays the contents of the file.
- If your hyperlink contains an email address, a message window opens in your default email program, with the address supplied already filled in.

## Moving a hyperlink



You can easily move or copy a hyperlink from one branch to another.

- To move a hyperlink, select it in the Object list of the original branch and drag it to the branch you want to move it to.
- To copy a hyperlink, select it in the Object list of the original branch, press the Ctrl key and drag it to the branch you want to copy it to while keeping the Ctrl key down.

## Deleting a hyperlink

To delete a hyperlink, select it in the Object list and do one of the following:

- Press **Delete**, or
- Choose **Delete** in its local menu.

 Remember that if you delete a hyperlink by accident, you can always cancel the deletion by clicking **Undo**  in the Quick Access Toolbar or pressing **Ctrl + Z**.

## Hyperlink properties

Hyperlinks have properties, which you can edit in the **Properties** dialog.

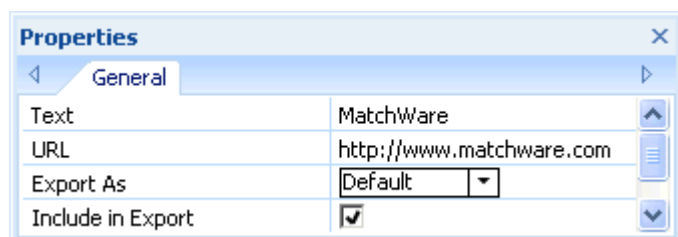

See "[Hyperlink properties: General tab](#)" for a detailed description of the properties applicable to hyperlinks and "[Using the Properties dialog](#)" for a general description of the Properties dialog.

 If the Properties dialog is not visible, choose **View | Show/Hide | Properties** to open it.

## Creating branch connections



MindView allows you to indicate visually that two or more branches of your map are conceptually related by adding branch connections between them.

You can create two types of branch connections:

- **Internal branch connections**, which connect two branches of the same map, or
- **External branch connections**, which connect two branches belonging to two different maps.



To create an external branch connection, both maps must be open. You must also make sure that the map where you want the connection to end has already been saved at least once.

### Creating a branch connection

- Choose **Insert | Links | Branch Connection**.  
The mouse pointer changes to a different shape.
- Click the branch or sub-branch you want the connection to start from.  
A thin line appears connecting the branch you selected and the mouse pointer.
- Click the branch where you want the connection to end.



If you are creating an external branch connection, you will first need to click the tab of the second map in order to display it.

A line ending with an arrow now connects your start branch with your end branch.

A paperclip icon  appears to the right of the start branch label to indicate the presence of an attached object. Moving the mouse pointer over this paperclip icon displays a pop-up list of all the objects attached. The branch connection also appears in the Object list of the start branch. By default, its name is the name of the end branch.

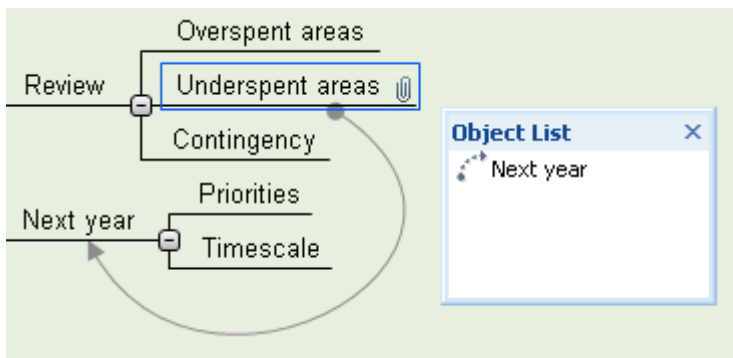

- (optional) Click the **Format** tab that appears at the right of the ribbon.  
This tab contains formatting options applicable to the branch connection.
- Browse through the options available in the different panels, checking their effect on the branch connection as you go.

As well as the Format tab, you can also use the Properties dialog to make changes to the branch connection.

See "[Branch connection properties: General tab](#)" in the Reference section for a detailed description of the properties applicable to branch connections and "[Using the Properties dialog](#)" for a general description of the Properties dialog.



To create several branch connections quickly, keep the **Ctrl** key down while connecting the various branches.

### Changing the curve of a branch connection

You can change the curve of a branch connection as follows:

- Click the branch connection to select it, either directly on the map or in the Object list of the start branch.

A handle appears at each end of the connection, made up of a straight line and a square.

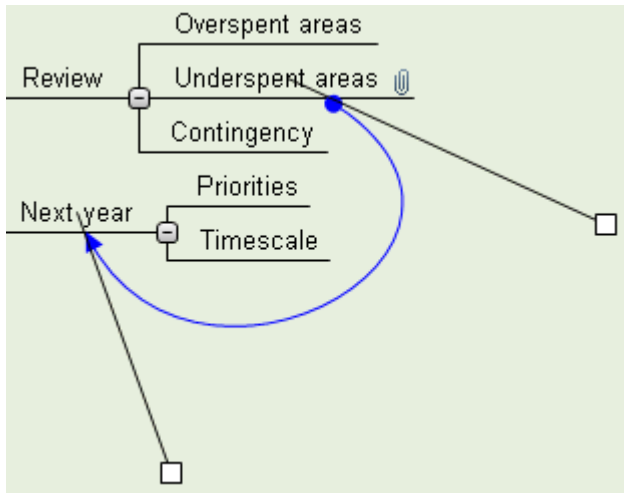

- Click the square of one of the handles and start dragging it.

The shape of the branch connection changes as you move the handle. As you extend the handle, the branch connection becomes more curved. Conversely, if you reduce the length of the handle, the branch connection becomes flatter.

- Move each handle in turn until you are satisfied with the shape of the branch connection curve.

### Activating a branch connection

If you are working on a large map, you can quickly go to the end point of a branch connection as follows:

- Select the start branch, then :
  - **Double-click** the branch connection in the Object list, or
  - Select the branch connection in the Object list and choose **Execute** in its local menu.

If the connection ends in a different map, MindView opens it automatically in a separate tab.

### Making a branch connection start or end on a different branch

You can easily change the start or end point of a branch connection without having to delete the existing branch connection and create a new one. To do this:

- Click the branch connection to select it, either directly on the map or in the Object list of the start branch.
  - To make the branch connection start from a different branch, drag the dot placed at the start of the connection to the new start branch.
  - To make the branch connection end on a different branch, drag the arrow placed at the end of the connection to the new end branch.

### Deleting a branch connection

To delete a branch connection, select it in the Object list and do one of the following:

- Press **Delete**, or
- Choose **Delete** in its local menu.



*Remember that if you delete a branch connection by accident, you can always cancel the deletion by clicking **Undo**  in the Quick Access Toolbar or pressing **Ctrl + Z**.*

## Using sources

If you are working on a research project or writing a paper, you will probably want to include a bibliography in your finished work. MindView can help you compile and maintain bibliography entries (known as **sources** in MindView) that you can use in your maps. When you export a map to Microsoft® Word, the sources used in the map are also exported and included in the resulting Word file as a bibliography.

If you want to add citations to particular elements of the map, you will have to create one or more sources first. It is not, however, necessary to use citations; you may create any number of sources without necessarily referring to them in any of the map elements, and just use them as a bibliography when you export your map. See "[Using citations](#)" for more information on inserting citations.



### Adding sources

- Choose **Review | Sources** and click **Add New Source** in the submenu.

The **Add New Source** dialog opens.

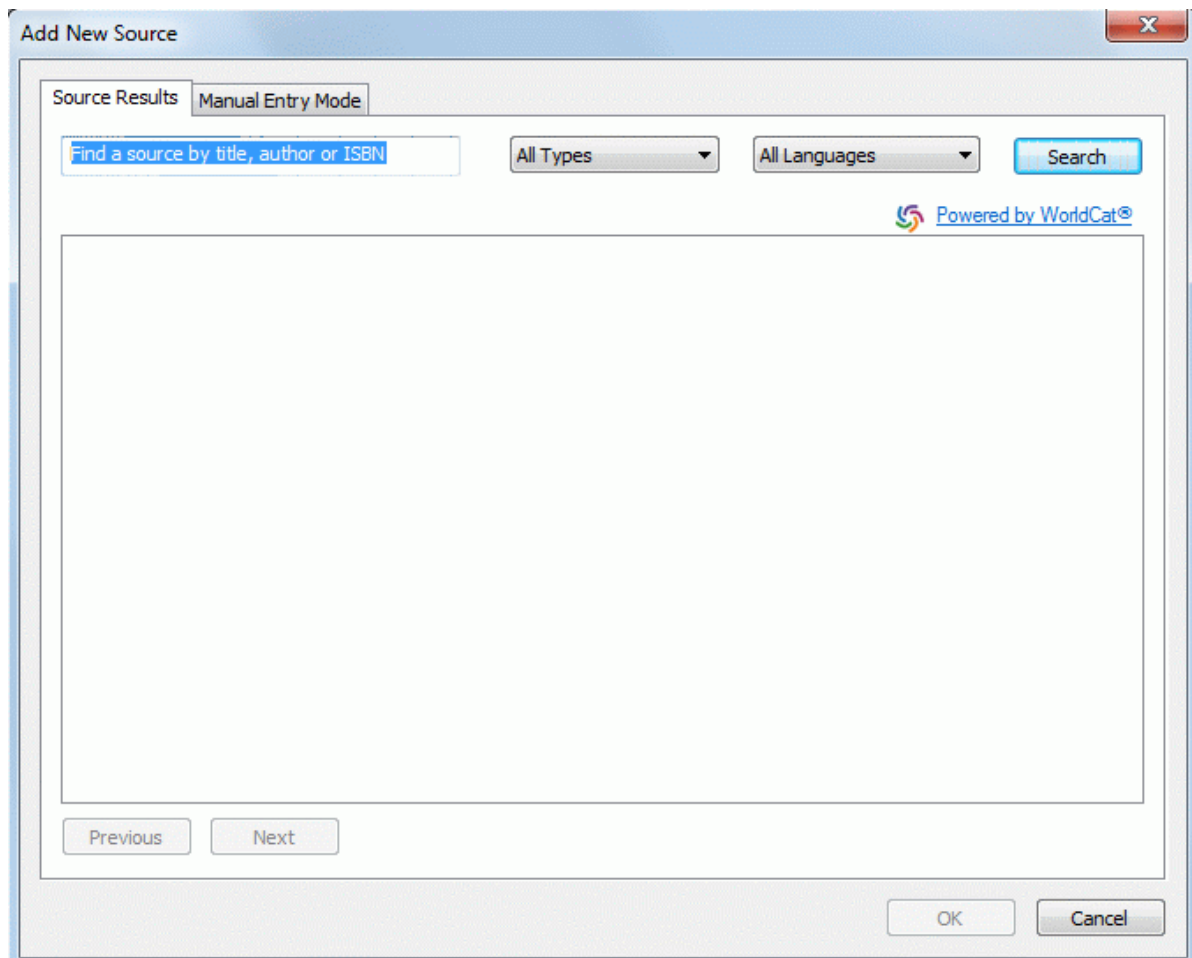

You can now search for sources online or enter source information manually.

### Searching for sources online

- Select the **Source Results** tab.
- Enter search criteria (e.g. an author's name or a publication title) in the search field.
- Select the source type and source language to search for on the drop-down lists.
- Click **Search**.

MindView searches the online library catalog WorldCat. Search results are shown in the dialog.

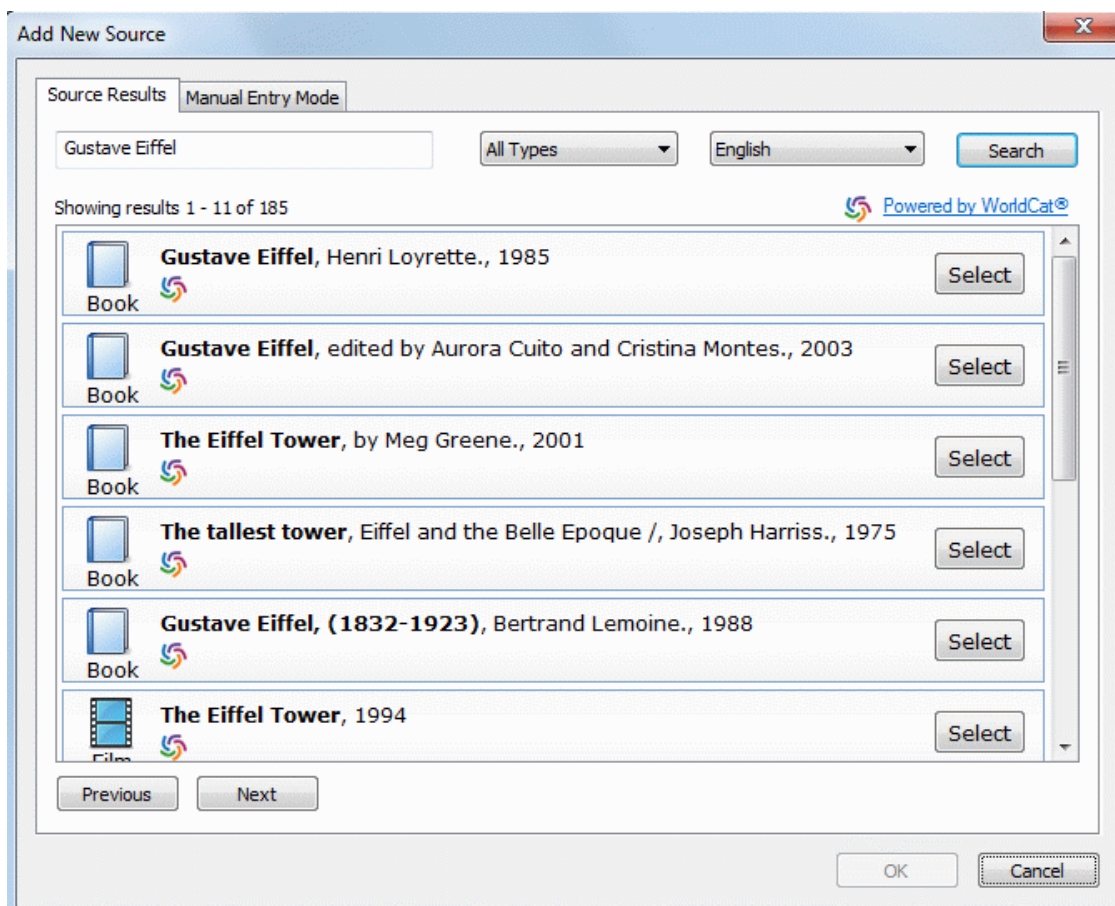

The source types found are indicated using icons:



Book



Film



Journal article

- Use the **Previous** and **Next** buttons to navigate between result pages, if applicable.
- Click the **Select** button for the source you want to include.



You may also click the **WorldCat** icon  to see the entry for the result on the WorldCat web site.

The application switches to the **Manual Entry Mode** tab where you may add information about the selected source.



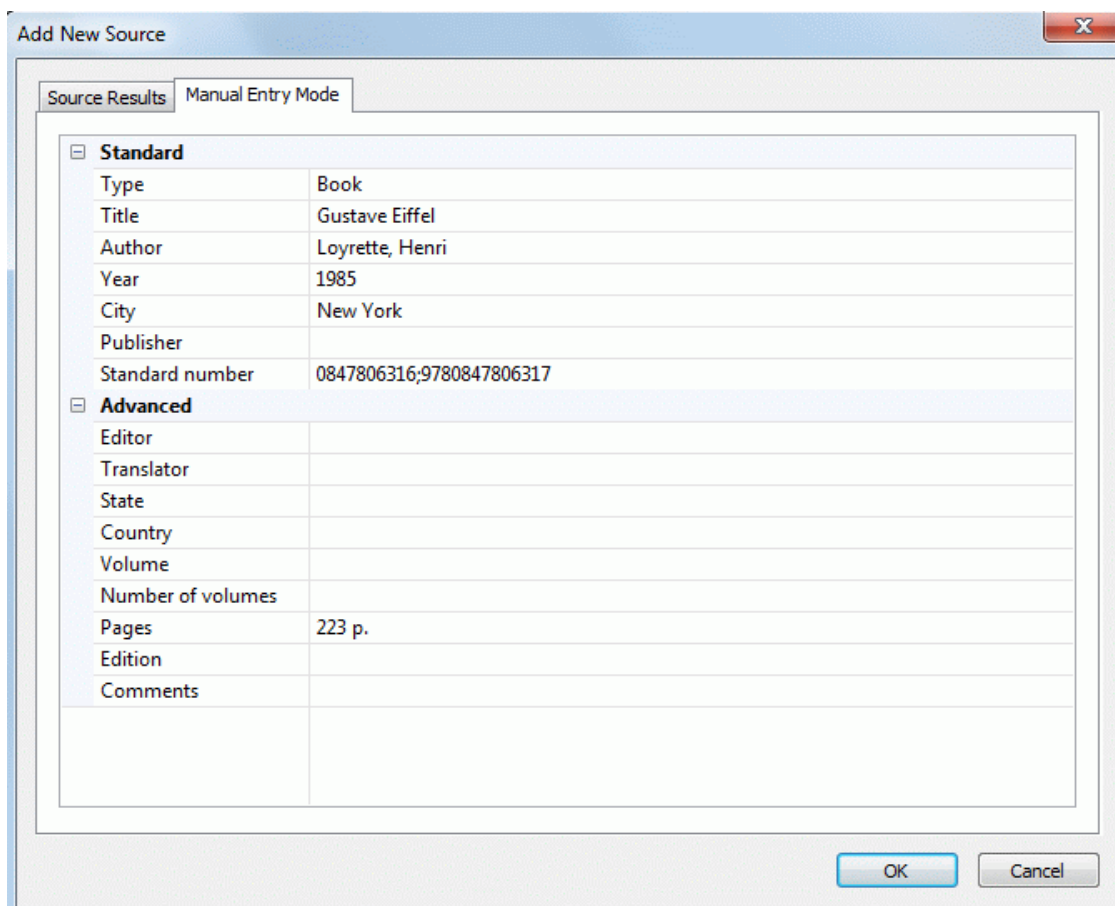

- Click OK to add the source to the map.

### Manually entering source information

- Click the **Manual Entry Mode** tab.

Standard	
Type	Book
Title	
Author	
Year	
City	
Publisher	
Standard number	
Advanced	
Editor	
Translator	
State	
Country	
Volume	
Number of volumes	
Pages	
Edition	
Comments	

- Select the source type to add on the **Type** drop-down list: **Book, Video, Internet site, Journal article**.
- Enter the desired information about the new source in the fields below the drop-down list. The fields available depend on the source type chosen.
- Click OK to add the source to the map.

### Viewing and managing sources

- Choose **Review | Sources** and click **Manage Sources** in the submenu.

The **Sources** dialog opens. Sources that have already been added to the map are displayed under **Existing Sources**.

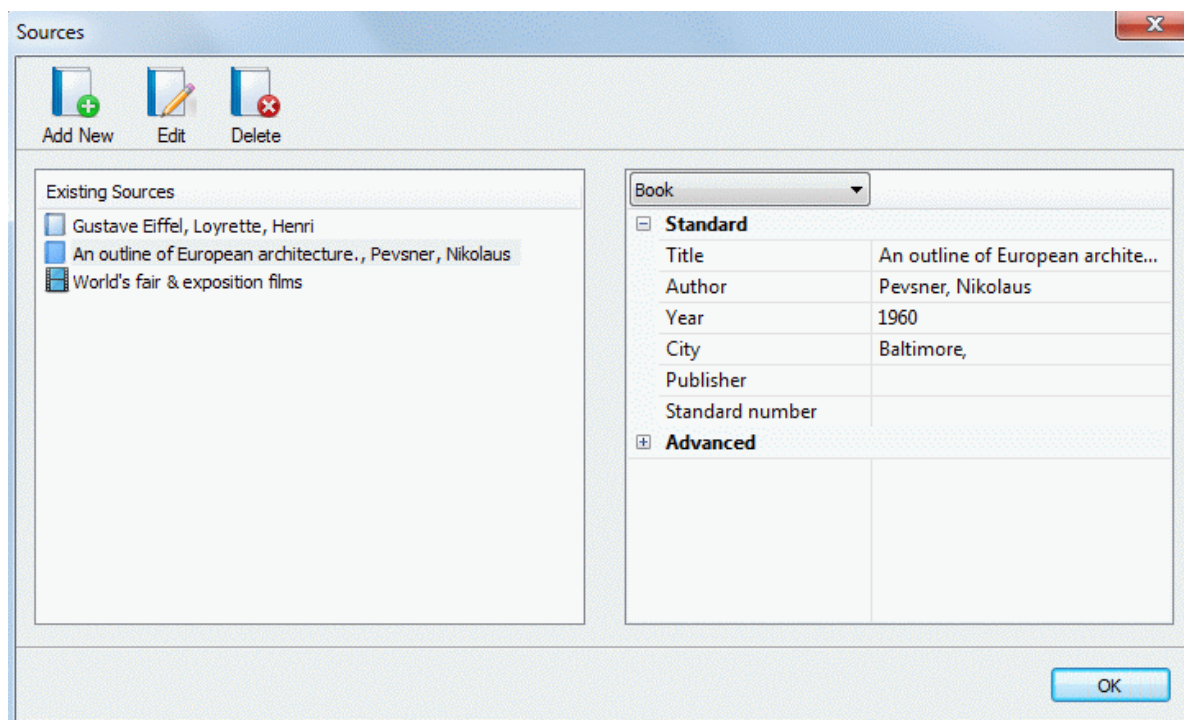

### Editing a source

- Select the source to be edited in the **Sources** dialog.
- Click **Edit**.

The **Add New Source** dialog opens on its **Manual Entry Mode** tab.

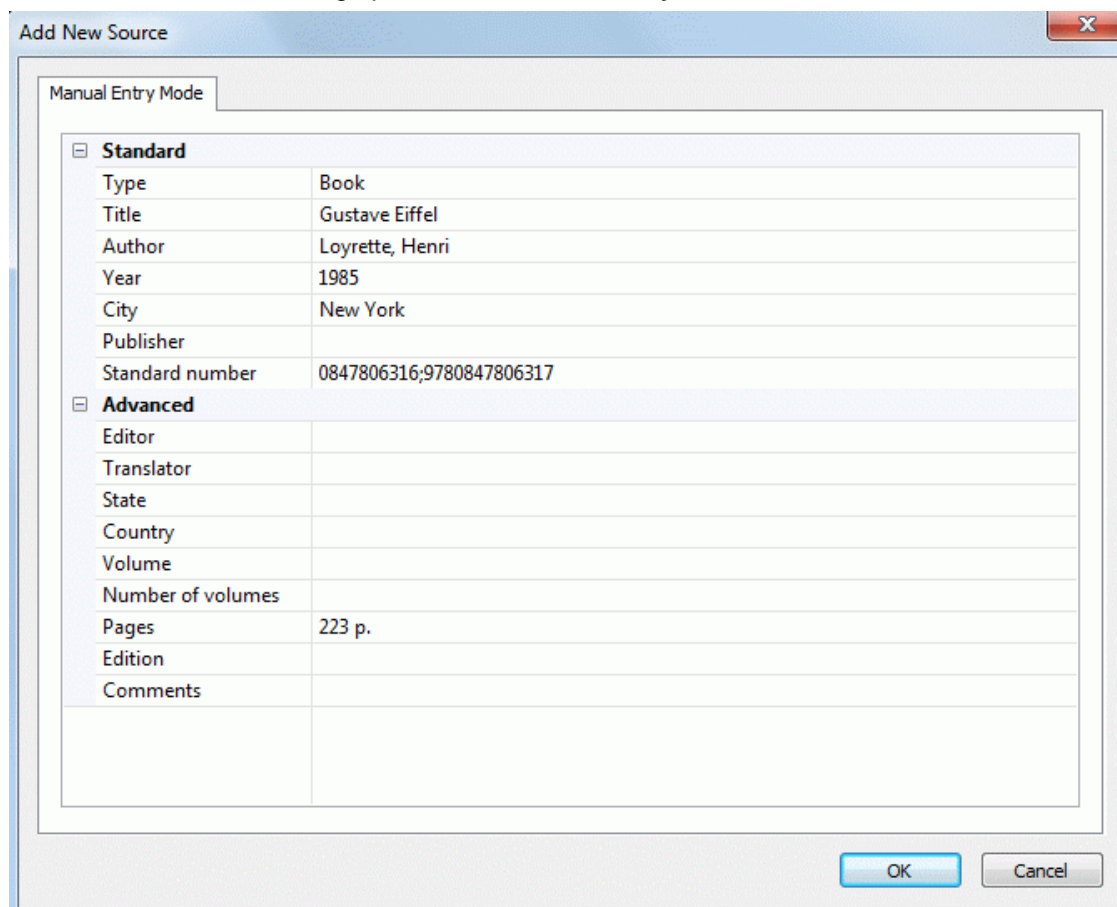

- Edit the desired information about the source.  
The fields available depend on the source type chosen.
- Click OK to update the source in the map when you have finished editing all fields.

### Deleting a source

- Select the source to be deleted in the **Sources** dialog.
- Click **Delete**.



If you delete a source that is cited on a branch or other element of the map, the actual citation is not deleted but the connection between citation and source is lost. If you then export the map to Microsoft® Word, the exported document will contain an error message because Word cannot find a source for the citations.

### Adding a source

- Click **Add New** and follow the procedure described under "Adding sources" above.

## Using citations

A citation is a reference to a published work. Citations may be handled in a number of ways but the standard method is to provide a page number and the name or author(s) of the source cited in parentheses, possibly preceded by a direct quotation from the source in quotation marks as in the following example:

"Everyday life presents itself as a reality interpreted by men and subjectively meaningful to them as a coherent world" (Berger & Luckmann, 33)

The text in quotation marks is a **quotation** while the text in parentheses is a **citation**. Full details of the source cited must then be provided in the bibliography (as the basic information provided in parentheses is not sufficient to properly identify the book (or other work) cited).

MindView cannot automatically insert quotations. If you need to enter a quotation (which is only possible in text notes), you must enter it manually. MindView can be used, however, to insert citations in text notes to link your quotation to a source. You can also insert citations directly on the branches of the map, on attachments and on hyperlinks.

If you export your map to Microsoft® Word, all the citations you have added are automatically placed in the correct location of the Word document. The full details of the corresponding sources are included in the Bibliography section located at the end of the Word document.



To insert a citation you must first create a source in the map. See "[Using sources](#)" for more information.

### Inserting a citation in a text note

- Open the text note where the citation is to be inserted.
- Place the cursor at the position where the citation is to be inserted in the note.
- (Optional) Type a quotation from the source.
- Choose **Insert | Links | Citation** and click **Insert Citation** in the submenu.  
The **Insert Citation** dialog opens.

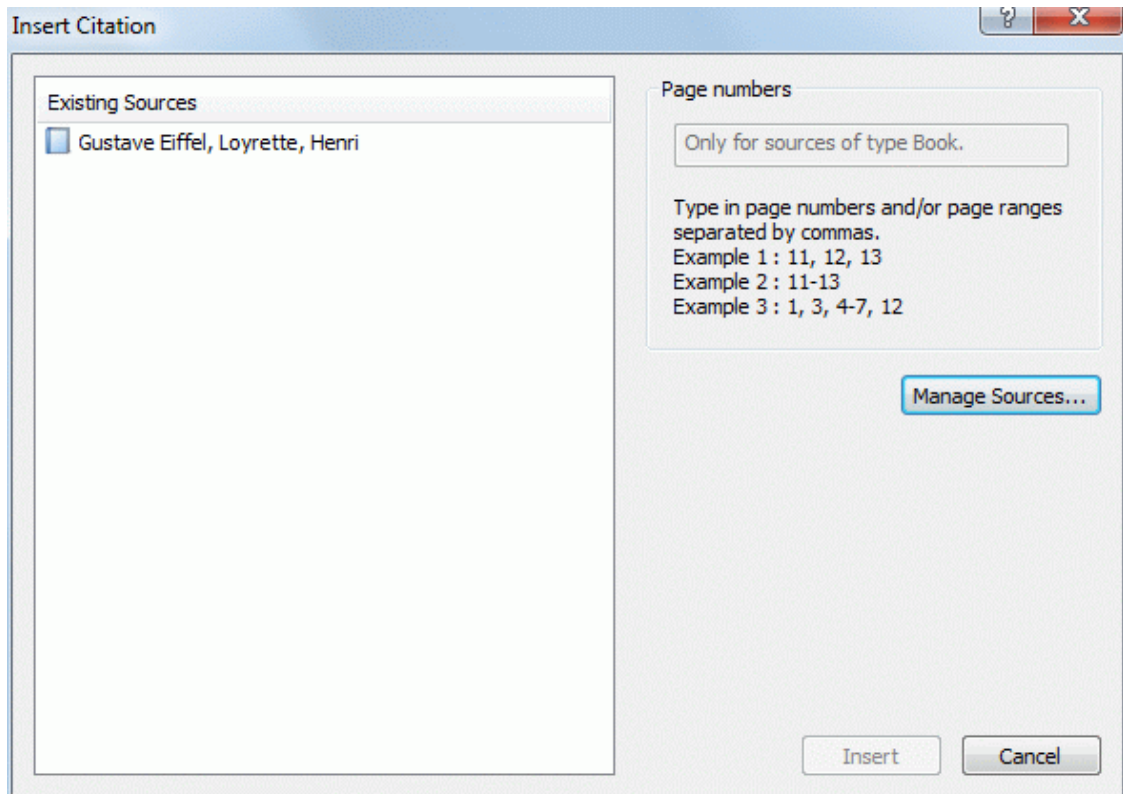

- Select a source in the **Existing Sources** list.



If you have not created any sources yet, you can click **Manage Sources** to do so. See "[Using sources](#)" for more information.

- (Optional; citations from books or articles only) Insert page numbers in the **Page numbers** field.
- Click **Insert**.  
The citation is now inserted in the note.

### Inserting a citation on a branch

You can also insert citations directly on branches.

To do this, select the branch, then follow the procedure described above for text notes.





When inserting a citation on a branch, the citation is not visible on the branch itself. To see a list of the citations you have inserted on a branch, select the branch, choose **Insert | Links | Citation** and click **Manage Citations**.

### Inserting a citation on an attachment or a hyperlink

You can also insert citations on attachments and hyperlinks.

To do this:

- Select the branch containing the attachment or hyperlink.
- Move the mouse pointer over the paperclip icon  shown on the right of the branch label to indicate the presence of the attachment or hyperlink.
- Right-click the attachment or hyperlink in the pop-up list that opens and choose **Citation | Insert Citation** in the local menu.
- Follow the rest of the procedure described above for text notes.

 As is the case for branches, citations inserted on attachments and hyperlinks are not visible. To see a list of the citations you have inserted on an attachment or a hyperlink, right-click that attachment or hyperlink and choose **Citation | Manage Citations** in its local menu.

## Viewing and managing citations

- Select the element containing the citation as follows:
  - For text notes and branches, choose **Insert | Links | Citation** and click **Manage Citations** in the submenu.
  - For attachments and hyperlinks, choose **Citation | Manage Citations** in the local menu.

The **Manage Citations** dialog opens.

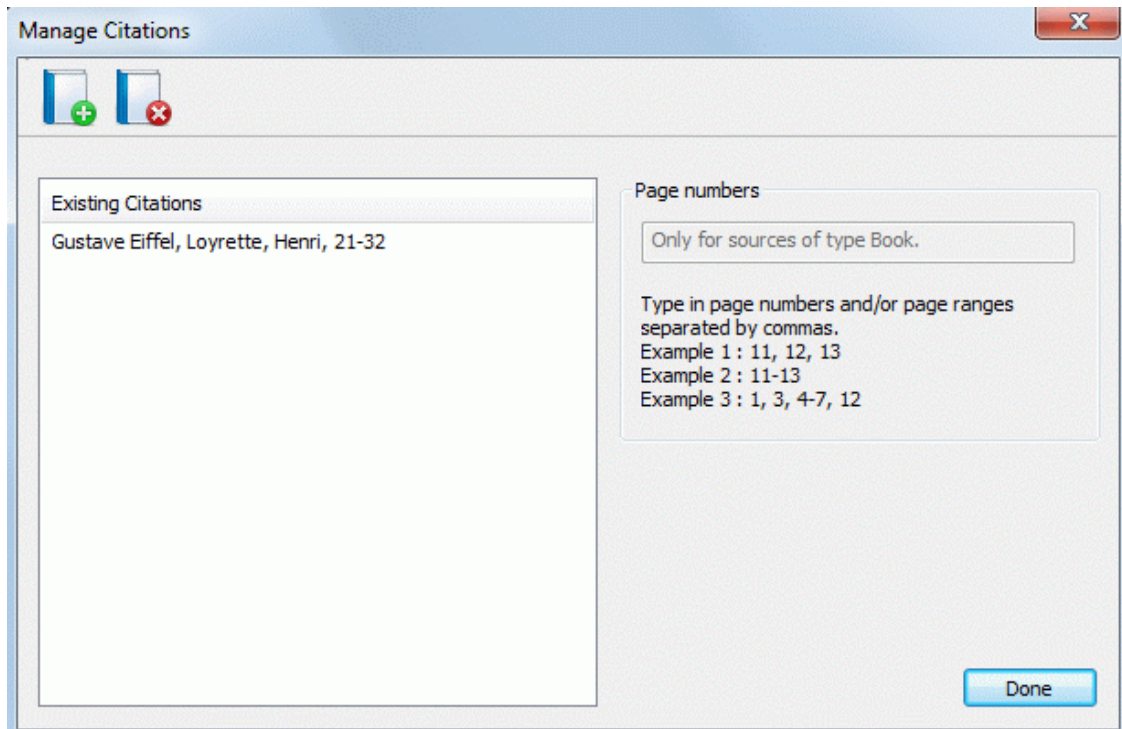

- You can now:
  - Add a new citation by clicking the **Add** button at the top of the dialog.
  - Remove a citation by selecting it, then clicking the **Remove** button at the top of the dialog.
-  This deletes the citation, but does not delete the corresponding source, which stays included in the map.
  - Edit the citation's page numbers (books and articles only).
- Click **Done** to save your changes.

## Finding and replacing text



MindView lets you search for every occurrence of a specific word or phrase and replace these automatically with a new word or phrase you specify.

You can find and replace text in the following elements:

- Branch names
- Floating comments



- Pop-up comments
- Text notes
- Object names

## Finding text

- Choose **Review | Editing | Find/Replace** or press **Ctrl + F**.

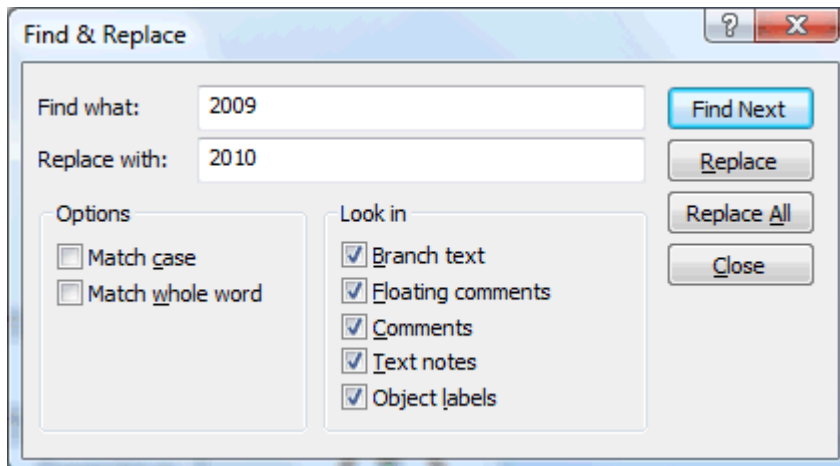

- Enter the text that you want to search for in the **Find what** field of the Find dialog.
- Select the search options required in the **Options** group.
- Select the elements that you want MindView to search in the **Look in** group.
- Click **Find Next**.

MindView goes through your document, looking for the text you specified in the elements you selected. As soon as it finds an occurrence of the text, it selects the element containing the text and highlights it.

You can now:

- Close the Find dialog and continue your work.
- Look for the next occurrence of the text by clicking **Find Next**.
- Replace the text with another word or phrase you specify in the Find dialog.

## Replacing text

- Type the replacement text in the **Replace with** field.
- Click **Replace** to replace the current occurrence only or **Replace All** to replace all occurrences throughout the document.



To cancel a search in progress, press **Esc**.

## Desktop search

MindView supports Windows Search on Windows XP and above, letting you locate specific data within all the mind maps stored on your hard disk and identify the relevant files instantly. All the data contained within your MindView documents is searched, including branch text, comments and searchable embedded files (such as Word documents).



To search file contents in Windows Vista, perform an Advanced Search and check the option "Include non-indexed files".

For more information on how to use Windows Search to locate information stored in your documents, please refer to your Windows help system.



## Inserting a new root



MindView allows you to create several maps in the same view by inserting several roots in it. This can be useful if, while working on your map, you have ideas as yet unrelated to your existing topics (i.e. branches). Once you have decided how they should be related, you can convert your new maps into branches of your existing map, or even move them to new documents altogether, as described below.



This procedure is only relevant to the standard Map views, namely Mind Map, Top Down and Left/Right.

## Inserting a new root in the view

You can do this in two ways:

- Choose **Insert | Branches | New Root** in the main menu, or
- Right-click the workspace and choose **Insert | New Root** in its local menu.



You can also create a new map by detaching a branch of your existing map, either to the same document or to a new document. See "[Detaching a branch](#)" for more information.

## Attaching a newly created map to an existing map

If you have created a second map in your document by inserting a new root into it, you can integrate it to your original map as follows:

- To attach it as a main branch, drag its root to the original root.
- To attach it as a sub-branch, drag its root to the branch or sub-branch you want to attach it to.

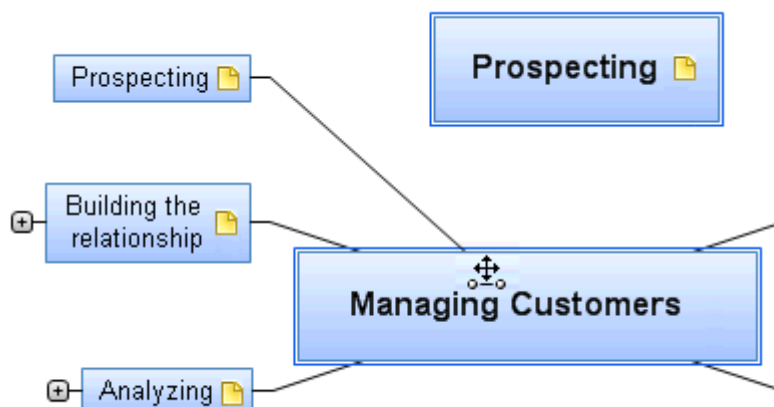

## Moving a newly created map in a separate document

- Select the root of your new map and choose **Cut** in its local menu or **Home | Clipboard | Cut** in the main menu (or press **Ctrl + X**).
- Create a new document (click the **File** tab and choose **New** or press **Ctrl + N**).
- Once the new document tab opens, right-click the workspace and choose **Paste** in its local menu or **Home | Clipboard | Paste** in the main menu (or press **Ctrl + V**).
- (optional) Delete the default root created automatically in the new document.

## Detaching a branch

MindView allows you to create several maps in the same view by inserting several roots, as described in "[Inserting a new root](#)". You can also create a second map by detaching an existing branch of your mind map, either to the same document, or to a new document. This can be useful when you realize that one of your existing topics (i.e. branch) does not in fact belong to your map, or if you want to consider a particular branch as the source of a new map.



This procedure is only relevant to the standard Mind Map views, namely Mind Map, Top Down and Left/Right.

### Detaching a branch to the same document

- Select the branch you want to detach and choose **Detach | Branch** in its local menu.

### Detaching a branch to a new document

- Select the branch you want to detach and choose **Detach | Branch as New Document** in its local menu.

In both cases, the selected branch and all its sub-branches, inserted elements and attached objects becomes a new mind map.

## Setting a password



MindView helps you to prevent unwanted access to your documents by protecting them with a password. Password-protected documents are also automatically encrypted. Longer passwords give a stronger level of encryption.

- Click the **File** tab.
- Choose **Set Password**.

The **Set Password** dialog appears.

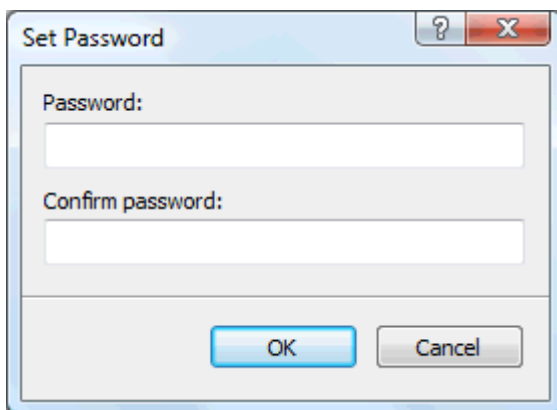

- Enter the password in the top field.
- Click the bottom field and enter exactly the same password. Confirm by clicking OK.

From now on, MindView will prompt you to enter the password every time you try to open the document.

You can change the password by entering a new password in the dialog.

To remove the password, clear both fields and save the document.



*Do not lose your password! It is not possible to open a password-protected MindView document without entering the correct password.*

## Tracking changes



MindView lets you track all the changes that have been made to your document, by yourself or any other user who has access to it. This is particularly useful if you are sharing your document with other colleagues or students, or if you are working on an online document, as it allows you to review all the changes made by other people.

- To enable the tracking of changes, choose **Review | Track Changes**.
- (optional) Click the down arrow at the bottom of the Track Changes menu and choose **Show Changes** to display the Changes Review panel.

All the significant changes you make to your document from this point are now listed in this panel as soon as you complete them.

Changes			
	Date	Description	User
	09.11.15 15:17:23	Edit Text: Quality systems	Genevieve
	09.11.15 15:17:56	Edit Text Note	Genevieve
	09.11.15 15:18:05	Insert Floating Comment	Genevieve
	09.11.15 15:18:12	Edit Text: Need to check ...	Genevieve
	09.11.15 15:18:34	Insert Branch	Genevieve
	09.11.15 15:18:56	Edit Text: Next stage	Genevieve
	09.11.15 15:19:05	Delete Branch: S.W.O.T.	Genevieve

To see on the mind map what branch or MindView element a particular change relates to, just click its entry in the Changes panel. You can also use the **Next** and **Previous** icons to navigate from one change to the other.

By default, new changes are added at the bottom of the Changes panel. You can however resort the list in reverse date order by clicking the arrow next to the Date header, or sort the list by Description or User.

As long as the tracking of changes is enabled, any change made to the document by anyone gets added to the Changes panel, even if the document is closed by its current user and re-opened by the same user or a different user at a later date. To stop the tracking of changes, you need to click Review | Track Changes again to disable it.

If you want to reset the list of changes, you can empty it by clicking the down arrow at the bottom of the Track Changes menu and choosing **Delete Changes History**.

## Creating a legend



Adding a legend to your map can make it much easier to read and interpret. You can for instance apply a particular color to some of the branches of your map, and then use a legend to give the meaning of this color.

In the example below showing the tasks to be considered when organizing an event, the tasks that have been completed have been tagged with a tick icon, and the next tasks that need to be done urgently have been highlighted using a red outline.

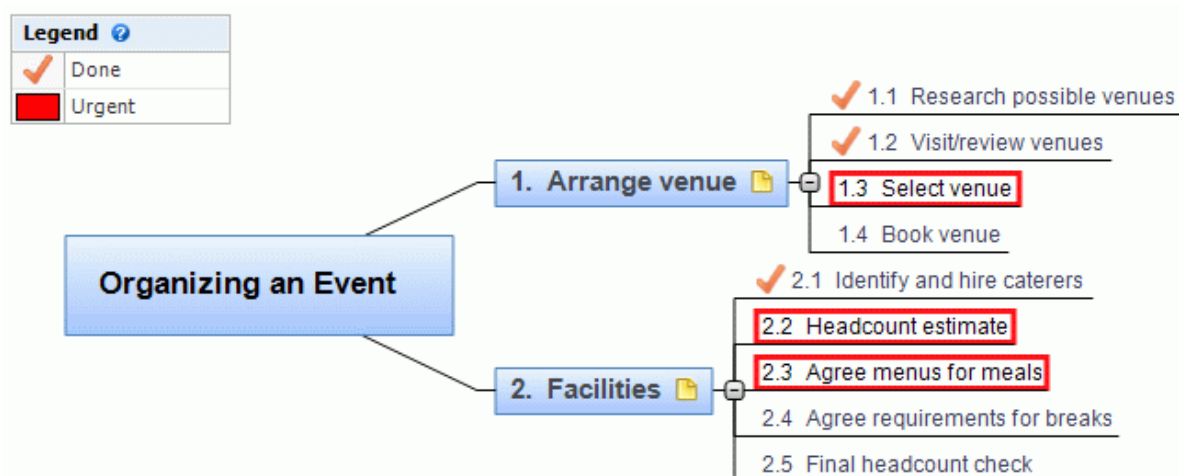

## Adding a legend entry

- Choose **View | Show/Hide | Legend** to display the **Legend** window.
- Move the mouse cursor over the Legend window.

- Click **Add Item**.

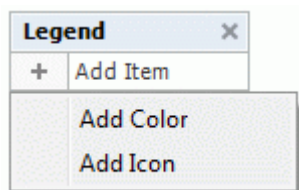

- Choose **Add Color** or **Add Icon** depending on whether you want to define your legend entry with a color or an icon.
- Choose the required color or icon in the dialogs that open.
- Replace the default label with the label of your choice.

You can now apply that color or icon to the branches that you want to single out.

## Removing a legend entry

- To remove a legend entry, just click the cross shown to the right of its name in the Legend window.

## Presenting a mind map







The MindView presentation mode lets you present your mind map to your audience branch by branch in full screen mode. To do this:

- Choose **View | Window | Presentation Mode**.

Your mind map is now displayed in full screen mode, and a small toolbar of icons appears.



These icons let you perform the following actions:

- Clicking the **Back** icon  lets you present your mind map in reverse (anti-clockwise) branch order by displaying the branch preceding the selected branch in the hierarchy.
- Clicking the **Next** icon  lets you present your mind map in normal (clockwise) branch order by displaying the branch following the selected branch in the hierarchy.
- Clicking the **Settings** icon  lets you configure the presentation mode.
- Clicking the **Exit** icon  lets you return to the normal Mind Mapping design mode.

## Configuring the presentation mode

When you click the **Settings** icon , the following dialog appears.

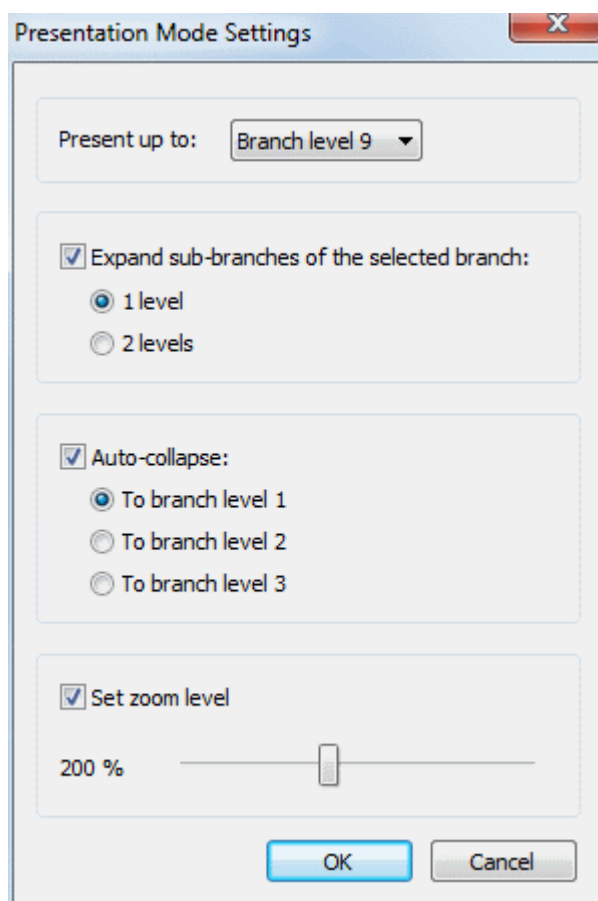

**Present up to:** This field lets you specify the number of branch levels to present when using the Next and Back icons. For example, if you choose to present your mind map up to Branch level 2, clicking the Next icon will select all the main branches and their first level of sub-branches, one after the other, but not their second and further levels of sub-branches.

**Expand sub-branches of the selected branch:** This field lets you specify how many levels of sub-branches of a particular branch should be displayed when that branch is selected. For example, if you choose to expand the sub-branches of the selected branch by 2 levels, when you present a main branch (i.e. that main branch is currently selected), MindView automatically expands its sub-branches (the first level) and their own sub-branches (the second level).

**Auto-collapse:** This field lets you specify how much of the branches of the mind map *other than* the selected branch should be visible, in other words how many levels of their sub-branches should be displayed on the mind map at any time. For instance, if you choose to auto-collapse the branches to Branch level 3, MindView always displays 3 levels of branches for all the branches other than the selected branch (whose behavior is controlled by the "Expand sub-branches" parameter above). Therefore when you enter presentation mode, you will see the root, the main branches and their first level of sub-branches.

**Set zoom level:** This setting allows you to adapt the zoom factor used while presenting your mind map. If for instance you have chosen to present all the levels of sub-branches, lowering the zoom factor will ensure that all the branches to be presented are always visible on the screen, without any need for horizontal or vertical scrolling.

## Checking a mind map



Before you export your map to other formats, or send it to colleagues, you may find it useful to check the list of all the files that you have included in it. This will also help you identify potential problems, for instance when a data file that you added to a particular branch as an attachment is no longer located in the folder you indicated when adding it.

- Click the **File** tab.

- Choose **Prepare | Data Files** to open the following dialog:

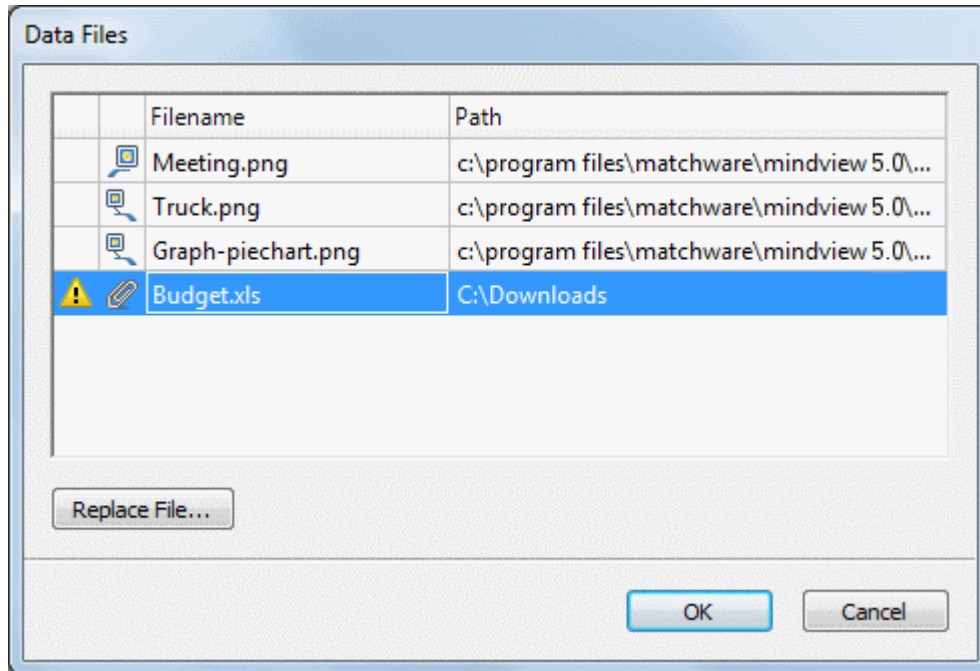

This dialog is made up of several columns:

- A Warning icon in the first column highlights a particular problem. Move your pointer on top of this icon to obtain more information about the problem.
- The second column contains icons that represent the nature of the data files that are listed: branch picture, floating picture, attachment and so on.
- The third column lists the names of the data files.
- The fourth column lists their respective paths.
- To replace a file by another or change its location, select the file in the list and click **Replace File**. You can also just double-click the file name in the dialog and browse to the new file or location.

## Packing a mind map



This feature makes it very easy to distribute your mind map to other users.

With a few mouse clicks, you can create a complete packed version of your mind map, ready to be sent via email, shared over the network or distributed via DVD or CD-ROM.

- Click the **File** tab.
- Choose **Prepare | Pack**.

As soon as you click OK in the message dialog that appears, MindView integrates all the external files that are attached to the mind map document (floating pictures, branch pictures, attachments and so on) within the .mvdX map file.

Once a map is packed, you can continue working with it as normal. Any attached file you activate from within the map opens in the relevant external application, letting you edit it as you wish. When you close this external application, all the changes you have made to the attachment are saved in the version of the attachment that is integrated to the .mvdX map file.

### Notes:

- Once you have packed a mind map, all the files you subsequently add to it (floating pictures, branch pictures, attachments and so on) are automatically packed in the .mvdX map file.
- If you have used the Additional Folders command to specify a list of folders to include when exporting to HTML, all the files contained in these folders are also integrated in the .mvdX file when packing the map. See "[Additional folders](#)" for more information about that command.

- If the MindView view contains several maps (i.e. several roots), they are all packed within the .mvdX file.
- When MindView opens a packed map, it starts by checking all the attached files that are packed in it. If the original version of any of these files has been updated since you packed the map, meaning that the version contained in the mind map is no longer the most up to date version, it displays a message to that effect, giving you the option of updating the mind map to the latest version.

## Unpacking a mind map

Although you can work in a packed map as normal as mentioned above, you also have the possibility of unpacking it. This may be useful if you want to retrieve the individual files that may have been attached to it, or to reduce the size of the .mvdX map file.

To do this:

- Click the **File** tab.
- Choose **Prepare | Unpack**.
- Choose a folder in which to place all the files attached to the map.

## Merging packed mind maps in a master map

You can easily merge into a master map several mind maps that have been packed using the Pack feature:

- Open your master map in MindView.
- Open each packed map in turn. Each document opens in a separate tab in MindView.
- Merge each packed map into your master map by copying its root (Ctrl + C) and pasting it onto the relevant branch of your master map. See "[Moving a branch](#)" for more information about copying and pasting branches.

 While performing this operation, make sure you do not close any of the packed maps before you have saved the master map.

## Sending a mind map



This feature makes it very easy to send your mind map to other users via e-mail.

- Click the **File** tab.
- Choose **Send**.

A message appears, asking you if you want the map to be packed into a single file before sending it:

- Choose **Yes** if you want to integrate all the external files that are attached to the mind map document (floating pictures, branch pictures, attachments and so on) within the .mvdX map file. For more information about the packing feature, see "[Packing a mind map](#)".
- Choose **No** if you only want to send the .mvdX map file, without the files that you may have attached to it.

A message is created in your default mail program, containing the mind map and a link to a free MindView viewer in case the recipients of your message do not have MindView installed on their computer. All you have to do is fill in the name of the recipients and the subject of your mail message before sending it.



## Using the Multimedia Catalog



The Multimedia Catalog contains a vast collection of high quality clipart pictures organized in many different categories or themes.

As well as business and web-related pictures, the Multimedia Catalog contains a large number of pictures created specifically to support both the curriculum-aligned templates included in MindView and your own curriculum-based mind maps.

All the Multimedia Catalog elements are free for you to use in your mind maps.

You can also store your own elements in the Multimedia Catalog. This enables you to re-use them whenever needed by dragging them from the Multimedia Catalog into your mind maps.

Finally, you can connect one or more of your User Area categories to one of your hard disk folders or to a shared network folder in order to view and use their contents. This feature is particularly useful when several users want to make use of the same multimedia elements stored on a shared network folder.

You can for instance connect one of your user categories to a folder containing different types of elements, such as videos, sounds or Flash files, which you can then drop onto your branches as attached objects.

- Click the **Multimedia Catalog** tab on the right of the workspace or choose **View | Show/Hide | Multimedia Catalog** to open it.

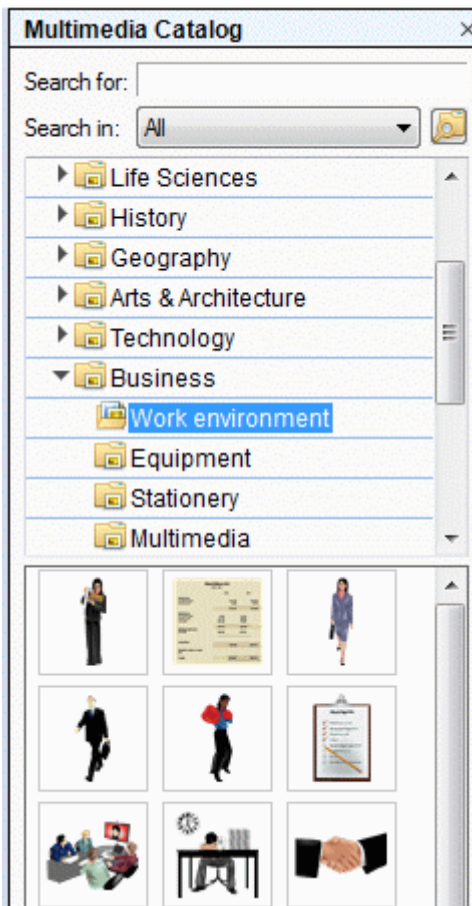

*You can resize the Multimedia Catalog window by placing the mouse pointer on one of its edges until it changes to a double arrow and dragging with the mouse.*

## Overview of the Multimedia Catalog

- **User Area:** This area is reserved for your own use. You can add or drag any element to it, create as many sub-categories as needed and even connect one or more of your user categories to an external folder. See "[Adding elements to the Multimedia Catalog](#)" below for more information.
- **Clipart:** Contains more than 1500 high quality illustrations covering many different educational fields, as well as business and web-related illustrations.
- **Favorites:** Place in this category any element you want to be able to find again quickly.
- **Recent:** When you add a Multimedia Catalog element to your document, this element is automatically copied to the Recent category. This allows you to quickly find recently used multimedia elements in case you want to use them again.
- **Search Results:** This category only appears once you have done a search in the Multimedia Catalog. It shows all the elements of the catalog that correspond to your search criteria.

## Browsing the Multimedia Catalog

- To see the contents of a category, select it by clicking it or by pressing the up or down arrow key on the keyboard.  
A right-pointing arrow next to a category name indicates that this category contains sub-categories.
- Click this arrow or press the right arrow key on the keyboard to show the list of sub-categories.

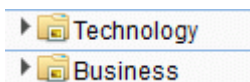

You can collapse a category again by clicking its arrow or by pressing the left arrow key on the keyboard.

- To examine a particular multimedia element more closely, place the mouse pointer over it.  
This shows an enlargement of the element as well as relevant information such as its name and size.

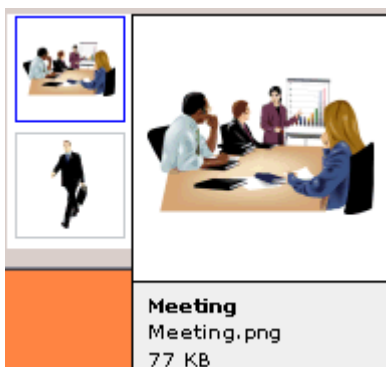

- To insert a Multimedia Catalog element in your mind map, just drag it from the catalog.

## Using the Favorites category

If you often use the same elements, placing them in the Favorites category allows you to find them again very quickly. You can do this in two ways:

- Right-click the relevant element and choose **Add to Favorites** in its local menu.
- Drag the element from one of the Multimedia Catalog categories to the Favorites category.



The element is now copied to the Favorites category. If you want to remove it from this category at a later stage, right-click it again and choose **Remove from Favorites** in its local menu.

## Searching the Multimedia Catalog

If you need a picture related to a particular theme (for instance Europe), you can search the entire catalog for that theme:

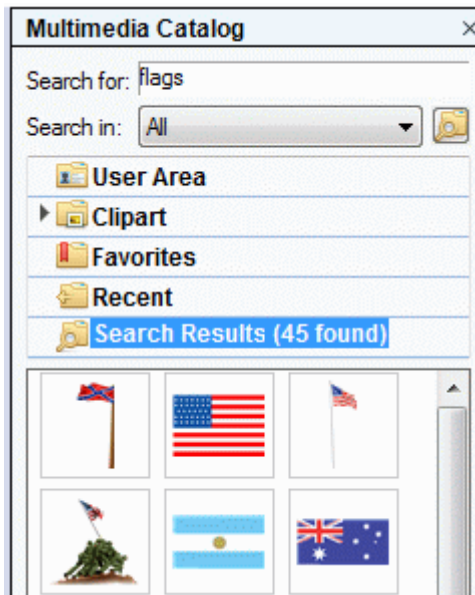
- Type a search word in the **Search for** field. For instance, if you are working on a map describing various countries and want to insert their flags on the map, start typing the word "flags". As soon as you enter the 3rd character (i.e. the letter "a"), pictures of flags appear in the Search Results category.
- (optional) If you want to restrict the search to a particular category, select this category in the **Search in** field and click the **Search** icon  to restart the search.
- Scroll down the Search Results category until you find the flag you require.



 During a search, the Search icon changes to . You can interrupt a search at any time by clicking this icon.

Searches in the Multimedia Catalog are keyword-based. Many different keywords have been associated with the Multimedia Catalog elements to help you find rapidly what you need. By way of example, here is a small selection of the many different keywords you can search for:

people, men, women, children, buildings, symbols, countries, maps, flags, animals, plants, computing, transport

When you enter the first few characters of a word or a full word in the 'Search for' field, MindView goes through all the keywords that have been associated with the Multimedia Catalog elements. All the elements which have one or more keywords containing the characters you entered appear in the Search Results category.

You can view the keywords associated to a particular element and even add your own as follows:

- Right-click the element in the Multimedia Catalog display area.
- Choose **Properties** in its local menu.

The **Properties** dialog appears.

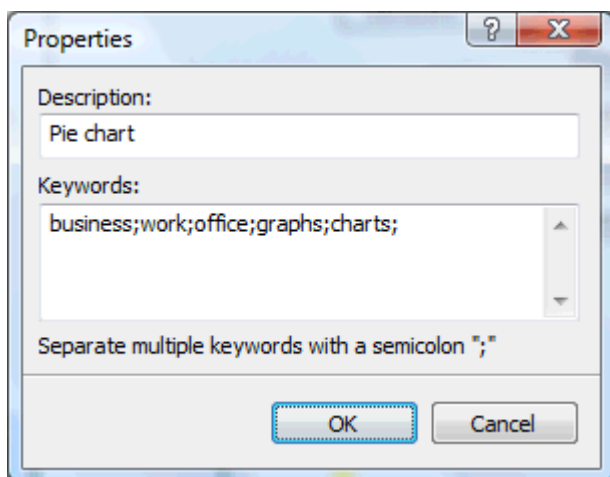

- Type the new keywords you want to associate with this element, separating them with semicolons.



The Properties dialog also lets you edit or remove unwanted keywords or change the description that appears when you view an enlargement of the element.

### Adding elements to the Multimedia Catalog

You can keep your own elements in the Multimedia Catalog for future use, either in an existing category or in the User Area. You are also free to create your own categories within the User Area, rename them or delete them.

- Any element you add to one of the existing categories of the Multimedia Catalog is identified by a small shortcut icon, indicating that the element is not actually copied to the Multimedia Catalog, but only inserted as a link to the actual element.



- Any element you add to one of the User Area categories is identified by a small gray arrow.

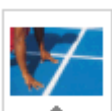

There are different ways of adding an element to the Multimedia Catalog. Here is one of them:

- Select the category to which you want to add the element.
- Right-click the category and choose **Add Element** in its local menu.
- Choose the required element in the Open dialog.

You can also add elements by dragging them from the Windows Explorer or the desktop.

### Renaming an element

You can give relevant names to all the elements you add to the Multimedia Catalog or rename existing elements as follows:

- Right-click the element you wish to rename and choose **Properties** in its local menu.
- Enter a new description for the element.

The new description will appear whenever you view the enlargement of the element.

### Deleting an element

You can delete any element you have added to the Multimedia Catalog as follows:

- Right-click it and choose **Delete** in its local menu or select it and press Delete.

## Creating a category within the User Area

You can create your own categories within the User Area as follows:

- Right-click the User Area or the sub-category of the User Area in which you want to create a category.
- Choose **Create Category** in the local menu.
- Type the new category name in the white box that appears.

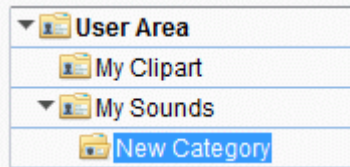

You can also rename or delete any category in the User Area by right-clicking it and choosing **Rename Category** or **Delete Category** respectively in its local menu.

## Connecting a category to an external folder within the User Area

MindView allows you to connect one or more of your user categories to one of your hard disk folders or a shared network folder. This feature is particularly useful when several users want to make use of the same multimedia elements stored on a shared network folder.

You could also connect one of your user categories to a folder containing different types of elements, such as videos, sounds or Flash files, which you can then drop onto your branches as attached objects.

- Right-click the main User Area or one of its sub-categories.
- Choose **Connect to Folder** in its local menu.

The **Connect Category to Folder** dialog appears.

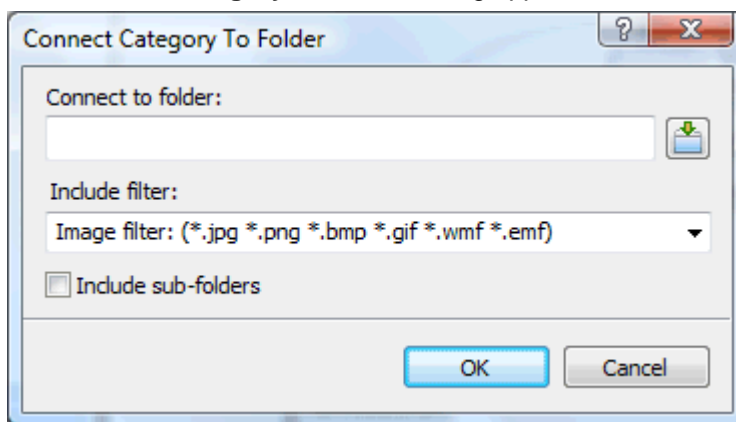

- Type the path of the folder you want to connect to or use the Browse button  to locate it.
- Choose the required filter. If for instance you only want to view the available videos, choose the Video filter.

Note that you can also type your own filter, such as \*.bmp; \*.jpg (separating the formats with a semi-colon as shown here) to see only pictures using these file formats or \*.\* to view all the files contained in the connected folder.

- (optional) Check the 'Include sub-folders' option if you also want to see the contents of all the sub-folders of the connected folder.

A new category is now created within the User Area, filled with all the contents of the connected folder that match the filter you specified. The new category takes the name of the folder that you connected it to. It is identified by a special icon to show that it is a connected category.

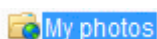

If the contents of the connected folder are likely to change while you are working with the Multimedia Catalog, for instance if the connected folder is a shared network folder to which other

users have access, you can refresh the connected category to make sure you see the latest contents.

- Right-click the connected category and choose **Refresh** in its local menu.

Note that you can also refresh any of the sub-folders of the connected category.



*If the connected folder is very large, the Refresh operation may take a long time. You can interrupt it by right-clicking the connected category and choosing Stop Refresh in its local menu.*

Finally you can change the filter used to view the contents or even change the connection by connecting to a different folder as follows:

- Right-click the connected category and choose **Modify** in its local menu.
- Choose a different path and/or a different filter in the Connect to Category Folder dialog as described above.

You can disconnect a connected category at any time as follows:

- Right-click the connected category and choose **Disconnect** in its local menu.



Disconnecting a connected category removes the link between your User Area and the folder you connected to, but does not affect the external folder or its contents in any way.

## Resetting the Multimedia Catalog

You can restore the original contents of the Multimedia Catalog at any time as follows:

- Click the **File** tab.
- Click **MindView Options** in the bottom right.
- Click **Preferences** on the left.
- Set **Reset Multimedia Catalog** to Yes.
- Click OK.

This will leave your User Area untouched, but removes all the elements you might have added to any other category.

## Using the Properties dialog



The Properties dialog shows the properties of the MindView element currently selected, for example the root, a branch or a floating comment. If nothing is selected the properties of the current view are shown.

You can use the Properties dialog to make fine-tuning changes to these elements.



*Rather than applying properties one by one to enhance the visual aspect of your branches, it is normally easier to use the **Format** tab shown at the right of the ribbon when the branch is selected. Using this tab, you can apply branch shapes, branch colors and other coordinated attributes in one step. Similarly, the **Design** tab lets you apply predefined layouts and styles to the entire map in one step.*

### Notes:

- If the Properties dialog is not visible, choose **View | Show/Hide | Properties** to open it.
- The properties described are not always applicable to all views. The Properties dialog only lists the properties applicable to the selected element in the current view.



*You can resize, dock and undock the Properties dialog according to your needs. See "[Using the MindView panels](#)" in the topic "[Setting up your workspace](#)" for more information.*

The Properties dialog shown below illustrates the general properties applicable to a branch. To see the properties applicable to the branch label, you would click its Text tab.

For a complete description of all the properties available for the various MindView elements, see the Reference section.

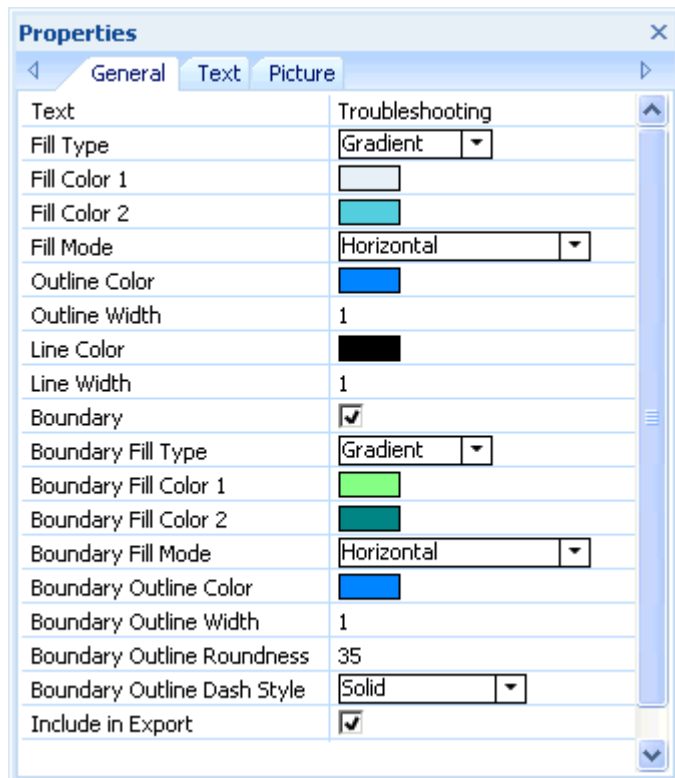

You can make the same change to several elements at once by selecting all the elements required first. Let's suppose for instance that you want to change the branch color of three of your 10 branches. All you have to do is to select the three branches before choosing the color with the 'Fill color' property.

## Editing properties in the Properties dialog

The way you edit a property depends on its type as follows:

- **Label:** Type in the new name or edit the existing name in the input field.
  - **Number:** Type in the new value in the input field.
  - **Check box:** Click the box to select it, click it again to deselect it.
  - **Path:** Type in a new folder and/or file name or edit the existing one, or click the Browse button  on the right side of the input field.
  - **Color:** Click the small rectangle and choose the new color in the Windows Color dialog. The upper left corner of the dialog shows all the predefined colors. To define your own color, click the required area of the color matrix on the right and use the slider on the extreme right of the dialog to adjust the color attributes. You can also enter the RGB values (Red, Green, Blue) or the Hue, Saturation and Luminosity values manually. The easiest way to experiment with different colors is to press and hold the mouse button and move the mouse pointer around the color matrix. To save a color for future use, click Add to Custom Colors.
- Once you have made the required change, press Enter to save the edited property.



You can also use the **Up** and **Down** arrow keys to move between properties and press **Enter** to start editing.

## Using the Overview panel



The Overview panel gives you a miniature view of your entire document.

- To display the Overview panel, choose **View | Show/Hide | Overview**.



The Overview panel is not available in the Outline view or the Gantt view.



 You can resize, dock and undock the Overview panel according to your needs. See "[Using the MindView panels](#)" in the topic "[Setting up your workspace](#)" for more information.

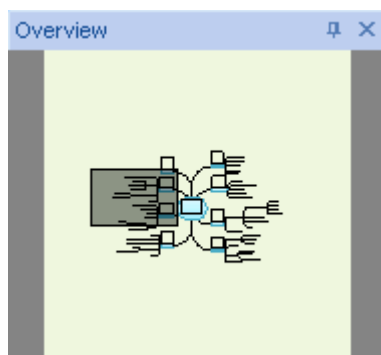

If your map is very large, the Overview panel can be a very useful tool to reach its different areas.

- Move the mouse pointer over the gray rectangle contained in the Overview panel until it takes the shape of a hand.
- Drag it in the direction of the map you want to explore and release the mouse button.

The main view changes to reflect the new position of the gray rectangle. Note that the positions of the elevators in the workspace scroll bars also change accordingly.

 You can achieve the same effect by using the workspace scroll bars, but the Overview panel has the advantage of giving you a complete representation of your map.

## Using the Object list



The Object list gives you a complete overview of the objects placed on the selected branch. It allows you to perform various operations on them, such as activating them, deleting them or displaying their properties in the Properties dialog.



If the Object list is not visible, choose **View | Show/Hide | Object List** to open it.

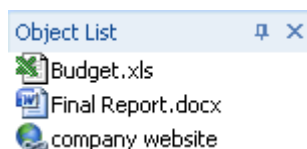

You can resize, dock and undock the Object list according to your needs. See "[Using the MindView panels](#)" in the topic "[Setting up your workspace](#)" for more information.

## Manipulating objects in the Object list

The Object list allows you to perform the following operations:

- Select an object by clicking its name.
  - The contents of the Properties dialog immediately changes to reflect the properties of the selected object, which you can then edit as required.
- Activate an object by double-clicking its name or choosing **Execute** in its local menu.
- Move an object up or down the list by drag and drop. This is only relevant if you intend to export your document and want the objects to be exported in a particular order, as it is the order of the objects in the Object list that dictates the order in which they are exported.
- Delete an object by choosing **Delete** in its local menu.

## Collaborating

### Accessing online workspaces



An online workspace is a remote site on the web where you can work collaboratively. Your documents are stored in the workspace where other users, such as colleagues or fellow students, can also access them provided they have your permission. You assign permissions (read only access, read/write access) to other users as necessary.

MindView supports two types of online workspaces:

- **Microsoft SharePoint®**

When you open a shared document in SharePoint, it is locked so that other users cannot make changes while you are working on it.

For information about Microsoft SharePoint, see the Microsoft web site.

- **MatchWare Shared Workspace**

This workspace, specific to MatchWare, lets several users access a shared MindView document at the same time. Changes to the document are updated continuously as you work so that other users can see the changes you make. If necessary you can assign permissions to individual branches of your own shared mind maps so that, for example, only particular users can make changes to particular branches.

The MatchWare Shared Workspace is hosted at: <https://workspace.matchware.com>. It is a service that is integrated with MatchWare MindView, but subject to its own Terms of Service. Accounts on the MatchWare Shared Workspace can be purchased from MatchWare as a yearly subscription. The service is also available as a 30-day free trial.

It is possible for organizations to host their own MatchWare Shared Workspace server. For more information, please contact MatchWare directly.

To find out how to open an online document, see "[Opening and saving online documents](#)".

To find out how to manage online workspaces, see "[Managing online workspaces](#)".

### Managing online workspaces



To add, change or delete connection details for an online workspace:

- Click the **File** tab or the **Share** tab on the ribbon.
- Choose **Open Online** or **Save Online** and then **Manage Online Accounts**. You can then:
  - Create new workspace access details by clicking **Add**. On the **Edit Workspace** dialog, enter a name for the workspace, its URL, and your user name and password. You can click **Test** to check that the access details are correct. Click **Save**.
  - Modify an existing workspace entry by selecting it and clicking **Edit**. The procedure is as described in the previous paragraph.
  - Delete a workspace entry by selecting it and clicking **Delete**.
- Click OK.

To find out how to open an online document, see "[Opening and saving online documents](#)".

### Opening and saving online documents



This topic explains how to open MindView documents hosted on an online workspace and how to save documents on the workspace, whether they were initially located on the workspace or not.

#### Opening an online document

- Click the **File** tab or the **Share** tab on the ribbon.

- Choose **Open Online**.
- Choose the relevant workspace.



If your documents are hosted on a SharePoint server, please see the Microsoft documentation or web site for information about how to use the SharePoint interface.

If you have chosen to work on documents hosted on the MatchWare Shared Workspace, the following dialog appears:

- Enter your MatchWare Shared Workspace user name and password and click **Connect**.

If you don't have a user name and password, click **Need an account?**. This will take you to the MatchWare Shared Workspace, where you will be able to create an account, provided that you or your organization are an authorized subscriber to this service. The service is also available as a 30-day free trial.

The **MatchWare Workspace** dialog now opens.

The upper part of this dialog lists all the workspace folders and documents which belong to you, whereas the lower part lists the workspace folders and documents which belong to other users, but to which you have been given access.

Name	Owner	Sharing	Access	Size	Date Modified
<b>My Documents</b>					
Accounts	gen@company.com	Shared	Read/Write		
Misc	gen@company.com	Not shared	Read/Write		
Projects	gen@company.com	Not shared	Read/Write		
Report 1.mvdx	gen@company.com	Shared	Read/Write	22.63 KB	24/10/2015 22:38:35
Report 2.mvdx	gen@company.com	Not shared	Read/Write	23.94 KB	24/11/2016 00:33:06
<b>Shared With Me</b>					
My Documents	richard@company...	Not shared	Read/Write		
Sales	richard@company...	Shared	Read Only		

The icon on the left of a folder name indicates the sharing status of the folder:

 denotes a folder belonging to you, that you have not shared with anyone.

 denotes a folder belonging to you, that you have shared with others.

 denotes a folder belonging to someone else, but that has been shared by its owner with you.

The name of the owner of the folder or document, and the sharing attributes you have to that element, are shown in the **Owner** and **Sharing** columns respectively.

The access rights (Read Only or Read/Write) you have to the folder or document are shown in the **Access** column.

If you see a folder identified as "not shared" listed in the "Shared With Me" section, it means that although the folder itself is not shared, it contains one or more document that the owner of the folder has shared with you specifically. To access these documents, double-click the folder to open it.

 Access rights to MindView documents and folders are managed online from the MatchWare Online Workspace. For more information, see the online help available on the workspace itself.

- If necessary, open the appropriate folder
- Select a document and click **Open**.

To find out how to work on a shared online document, see "[Collaborating on an online document](#)".

### Saving an online document

- Click the **File** tab or the **Share** tab on the ribbon.
- Choose **Save Online**.
- Select the relevant workspace.

If you have chosen to save your document on the MatchWare Shared Workspace, the MatchWare Workspace dialog described above now opens.

- Select the folder in which to save your document and supply a filename.
- Click **Save**.

 A document that is held on the MatchWare Shared Workspace is saved automatically whenever you make a change to it, so you do not need to save it explicitly, unless you want to save under a different name or to a different folder.

### Collaborating on an online document

 The procedures described here apply only to mind maps held on the MatchWare Shared Workspace. For information about using Microsoft SharePoint, refer to the Microsoft documentation or web site.

Any document held on the MatchWare Shared Workspace can be worked on from within MindView by several people at once, provided that the folder containing the document, or the document itself, has been shared by its owner and that all collaborating users have been given appropriate access rights.

Each time a user makes a change to the document using MindView, the change is automatically saved to the workspace and made visible to the other users of the document in MindView. Consequently, all users see the changes made by others as work progresses.

Access rights to MindView documents and folders are managed online from the MatchWare Online Workspace. For more information, see the online help available on the workspace itself.

### Branch locking

As well as determining who can access their folders and documents, the owner of a shared document can also assign permissions to individual branches of the mind map from within MindView, so that only particular users can make changes to particular branches.

Such restrictions are denoted by the presence of a Lock icon  to the right of the branch label. Moving the pointer over this icon gives you additional information about the operations you are allowed to perform on the branch.

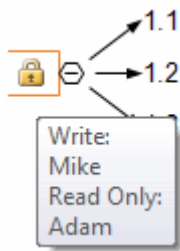



If you are the owner of a shared document, this is how you can assign permissions to individual branches of the mind map to particular users:

- Choose **Open Online** and select the document from the MatchWare Shared Workspace.
- Select the relevant branch.
- Choose **Share | Manage Locks**.

The **Branch Locking** dialog opens.

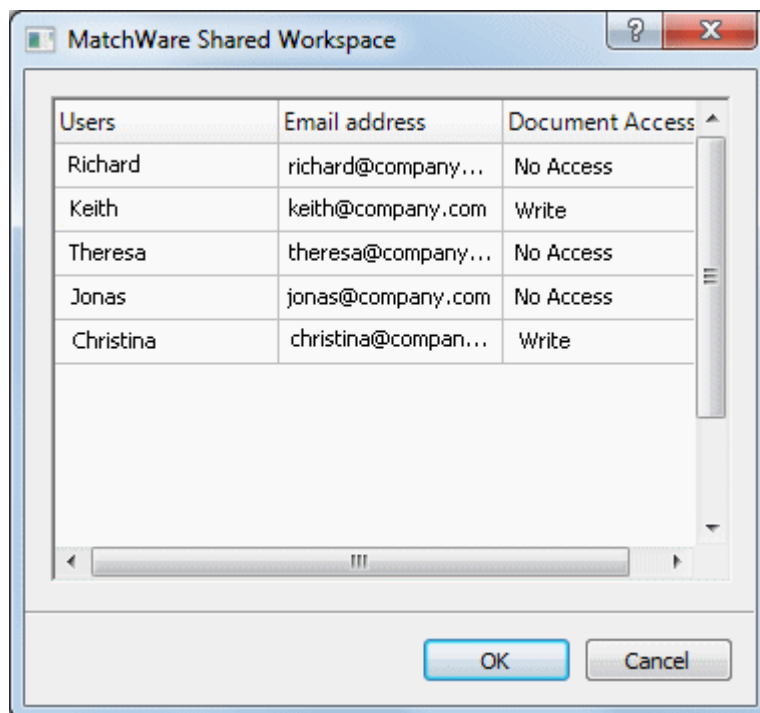
- Click **Add** and select the user or users to whom you want to grant specific branch permissions.



 The **Document Access** column records the access right that each user has to the document itself on the shared workspace. This access right must match the branch permission you are intending to give to the selected users. Let us suppose you intend to grant a Write permission to user Mike for the branch. If Mike only has Read access to the document, you can still grant him a Write permission to the branch, but he will not be able to edit that branch until you give him a Write access to the document from the shared workspace. For more information about granting access rights to documents from the shared workspace, see the online help available on the workspace itself.

- Click OK.
- In the **Branch Locking** dialog, give each user the appropriate permission, **Read Only** or **Write** (read/write). The permissions you assign apply to the branch you selected and all its sub-branches.

If you give a particular user a Write permission on a branch, all the other authorized users (except for yourself as the document owner) are automatically restricted to a Read Only permission on that branch. There is therefore no need for you to give them each individually a Read Only permission.

You can of course grant a Write permission on that same branch, or some of its sub-branches, to one or more other users individually, thereby allowing these users to work on the same branch at the same time, in true multi-editing mode.

As the owner of the document, you are not restricted by any Write permission given to other users, and are always able to edit the branch.

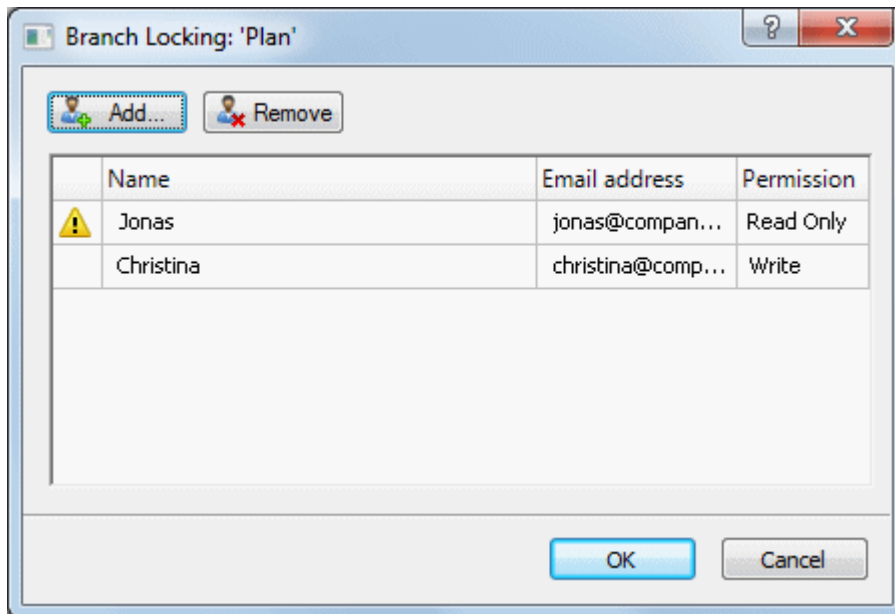

🔗 If a user does not have sufficient access rights to the document itself to grant him or her the branch permissions you have selected here, a warning icon ⚠ appears next to his or her name. As explained above, MindView allows you to grant such permissions, but they only become operational once you have given the required access rights to these users from the shared workspace.

- Click OK.

The Lock icon 🔒 now appears to the right of the branch label. Hovering that icon gives you a reminder of the permissions you have granted.

As owner, you can make changes to the permissions at any time by selecting the branch and clicking **Manage Locks**.

You can also remove all permissions on a locked branch at any time by selecting it and clicking **Remove All Locks**.

## Document locking

As well as locking specific branches, the owner of a document can also apply a lock to the entire document, by granting a Write permission to the document to a particular user. This will prevent all the other users from making any changes at all to the document, including inserting pictures and comments floating freely on the workspace.

As the owner of the document, you are not restricted by any Write permission given to other users, and are always able to edit the document.

You can however prevent all the other users from editing the document by giving yourself a Write permission to it.

The procedure to follow is almost identical to the procedure described above:

- Choose **Open Online** and select the document from the MatchWare Shared Workspace.

- Click the workspace to make sure no branch is selected.
- Choose **Share | Manage Locks**.
- Follow the rest of the procedure described above.

## Managing and tracking tasks



If you are using MindView to create an online task list or project plan, you can distribute the tasks to all the resources involved via email to the MatchWare Shared Workspace. The resources can then view and update the status of their tasks directly on the shared workspace as they work on them. You can then monitor the task status from MindView by re-importing the updated tasks into your online document.



For information on creating a task list or a project plan, see "[Inserting task data](#)".

Note that you can also export your task lists to Microsoft Outlook. For more information on the procedures involved, see "[Exporting to Microsoft Outlook](#)".

This procedure assumes that your MindView document is an online document hosted on the MatchWare Shared Workspace. If this is not the case, you will need to start by saving your document on the workspace. See "[Opening and saving online documents](#)" for more information.

The distribution of tasks via the shared workspace relies on email communication. You therefore need to enter valid email addresses in the online document for all your resources. For more information about this, see "[Assigning resources](#)".



You can only distribute tasks from an online document if you are the owner of that document. However, you do not need to be the owner of the document to be able to import tasks into it, provided that the owner has shared it with you. If the owner of the document has restricted your access by giving you Read Only status on some branches, the tasks corresponding to these branches will not be imported. If you are the document owner, all the tasks are imported.

## Distributing the tasks to the resources

To distribute the tasks to the resources via the workspace, proceed as follows:

- Choose **Share | Distribute Tasks to Resources**.

There are two distribution modes available:

- **Quick distribution**

The Quick distribution mode allows you to distribute the tasks to the resources straight away, using the MindView defaults.

- **Advanced distribution**

The Advanced distribution mode gives you more flexibility about the data to be distributed, as detailed below.



*If you have already distributed these tasks previously, you will be warned that it is safer to start by re-importing them from the shared workspace into your document, to avoid overwriting any task updates made online by the resources in the meantime.*

## Advanced distribution options

When you choose **Share | Distribute Tasks to Resources | Advanced Distribution**, the options you can choose from differ slightly depending on whether your document is a task list or a project plan. The dialog illustrated below assumes you are working on a Gantt project.



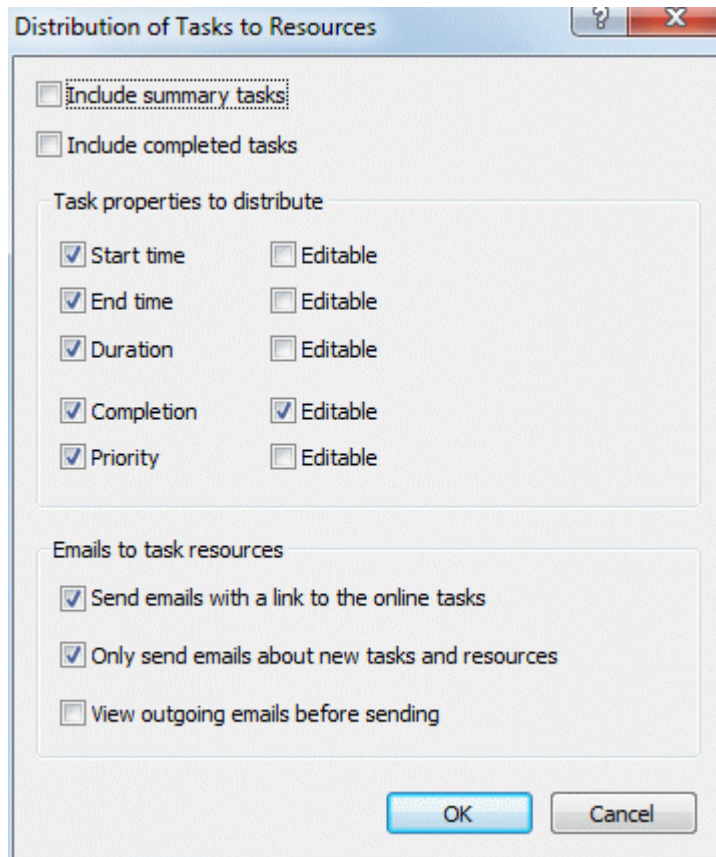

**Include summary tasks:** This option only appears if you are working on a Gantt project. Check it if you also want to distribute the summary tasks to the resources.

**Include completed tasks:** If this option is not checked, MindView only distributes incomplete tasks, i.e. tasks whose completion level is less than 100%.

**Task properties:** Check the task properties that should be visible to the resources on the shared workspace. For each property, you can also specify whether the resource should be allowed to modify the property online from the shared workspace or not.

**Send emails with a link to the online tasks:** If you check this option, MindView automatically sends a message to each of the resources, containing a link to the shared workspace where they can view and update their tasks as they start working on them.

**Only send emails about new tasks and resources:** When this option is checked, MindView only sends messages to the resources who have been allocated new tasks since the last distribution.

**View outgoing emails before sending:** If you check this option, MindView will prepare the messages, but will not send them automatically. This gives you the possibility of checking them and possibly adding your own message before sending them yourself.

- Click OK.

The tasks will now appear in the personal area of each of the resources on shared workspace, where they will be able to view them and update them. For information about managing tasks on the shared workspace, see the online help available on the workspace itself.

## Importing the tasks from the shared workspace

Once resources start working on their tasks and updating their status online on the shared workspace, you can periodically re-import these tasks into your MindView document to get an overview of the overall progress. To do this:

- Choose **Share | Import Tasks from Resources**.

Any task update made online is now imported into your document, letting you review the changes, make any adjustments needed to tasks or resources, and if necessary, redistribute the tasks.



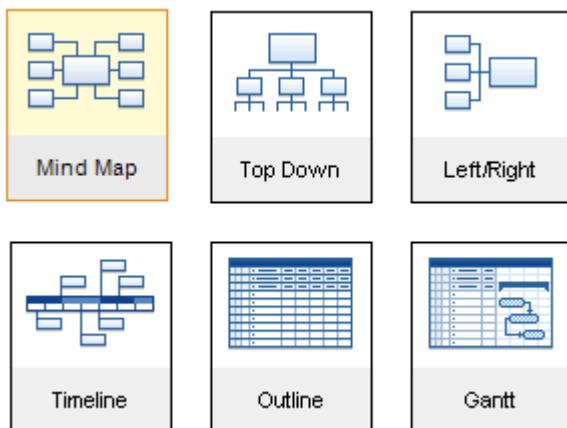

## Views

### Using different views



MindView allows you to view your mind map in different ways, depending on your personal preference, the nature of your data and the use you want to make of it.



The first four views, collectively referred to as "Map Views", are traditional Mind Mapping views:

-  The **Mind Map** view represents the map with the root in the center, and all the main branches radiating from it in a clockwise direction. See "[Using the Mind Map view](#)" for more information.
-  The **Top Down** view represents your map as a hierarchical pyramid, with the root at the top, the main branches underneath, the sub-branches below the main branches, and so on. See "[Using the Top Down view](#)" for more information.
-  The **Left** view represents your map as a list of topics placed on the left of the root. See "[Using the Left/Right view](#)" for more information.
-  The **Right** view represents your map as a list of topics placed on the right of the root. See "[Using the Left/Right view](#)" for more information.

The remaining views are specific views adapted to a particular purpose:

-  The **Timeline** view lets you display the branches of your map that contain time information in chronological order on a horizontal time axis. See "[Using the Timeline view](#)" for more information.
-  The **Outline** view represents the map as a hierarchical list which you can expand and collapse as required. See "[Using the Outline view](#)" for more information.
-  The **Gantt** view is dedicated to the creation, editing and management of project plans according to the rules of project management. See "[Using the Gantt view](#)" and all the topics that follow it for more information.

Once you have created your document, you can display it at any time in another view by choosing that view in the **Home | View** or **View | View** panels in the main menu or by right-clicking the workspace and choosing **View Map As** in the local menu.

Going from one view to another only affects the way the document is displayed. The contents of the document are not modified, unless you edit them yourself while working in the new view.

The only exception to this rule is the Gantt view. Going to the Gantt view automatically enables project management features, which may have consequences for your data.

## Mind Mapping views

### Using the Mind Map view

 This view represents the map with the root in the center, and all the main branches radiating from it in a clockwise direction. This is a good view to use when brainstorming all the ideas related to the main subject of the map without worrying about evaluating them or structuring them.



To display your mind map in this view, you can:

- Choose **View | MapView | Mind Map** in the **Home** or **View** tabs of the main menu, or
- Right-click the workspace and choose **View Map As Mind Map** in the local menu, or
- Press **Ctrl + Shift + 1**.

To find out how to use this view, refer to the "Basic tasks" and "Further tasks" sections of this documentation.

### Using the Top Down view

 This view represents your map as a hierarchical pyramid, with the root at the top, the main branches underneath, the sub-branches below the main branches, and so on. It is a useful representation for structured data which needs to be viewed in a hierarchical manner, in other words from the higher level to the lowest levels.



To display your mind map in this view, you can:

- Choose **View | MapView | Top Down** in the **Home** or **View** tabs of the main menu, or
- Right-click the workspace and choose **View Map As Top Down** in the local menu, or
- Press **Ctrl + Shift + 2**.

To find out how to use this view, refer to the "Basic tasks" and "Further tasks" sections of this documentation.



While in that view, you can change the display so that the sub-branches are displayed vertically by choosing that display in the **Layout** gallery of the **Design** tab.

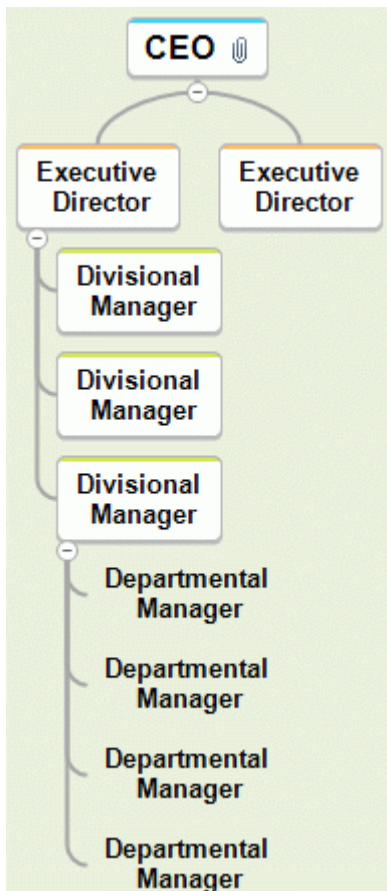

## Using the Left/Right view



This view represents your map as a list of topics placed on the right of the root. It is a good choice when you need to present structured data in list form (for instance a list of steps) and want to be able to fully explore each point in the list before going on to the next point.

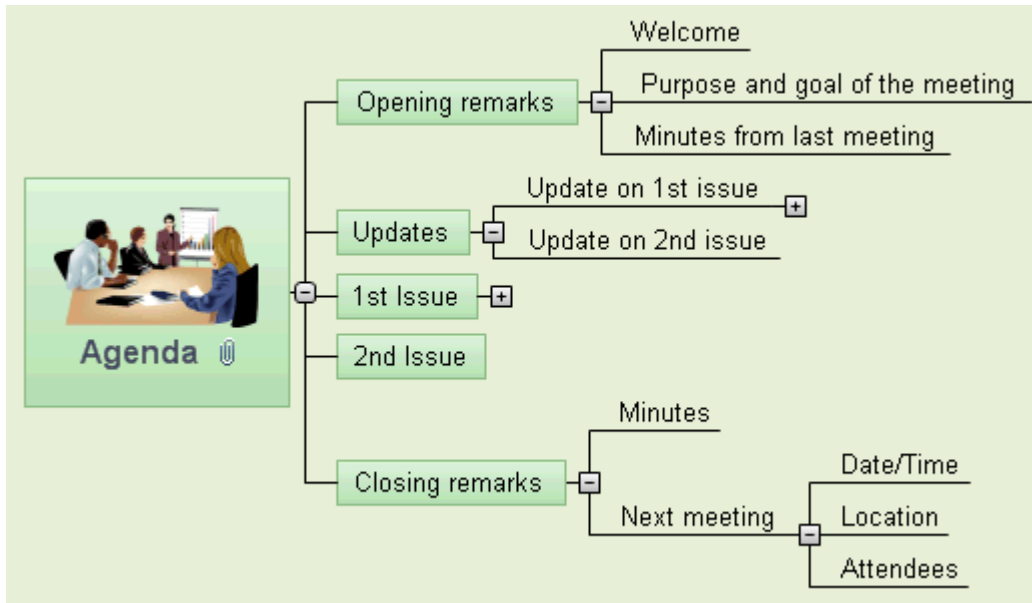

To display your mind map in this view, you can:

- Choose **View | MapView | Left/Right** in the **Home** or **View** tabs of the main menu, or
- Right-click the workspace and choose **View Map As Left/Right** in the local menu, or
- Press **Ctrl + Shift + 3**.

To find out how to use this view, refer to the "Basic tasks" and "Further tasks" sections of this documentation.



While in that view, you can change the display from Right to Left by choosing that orientation in the **Layout** gallery of the **Design** tab.

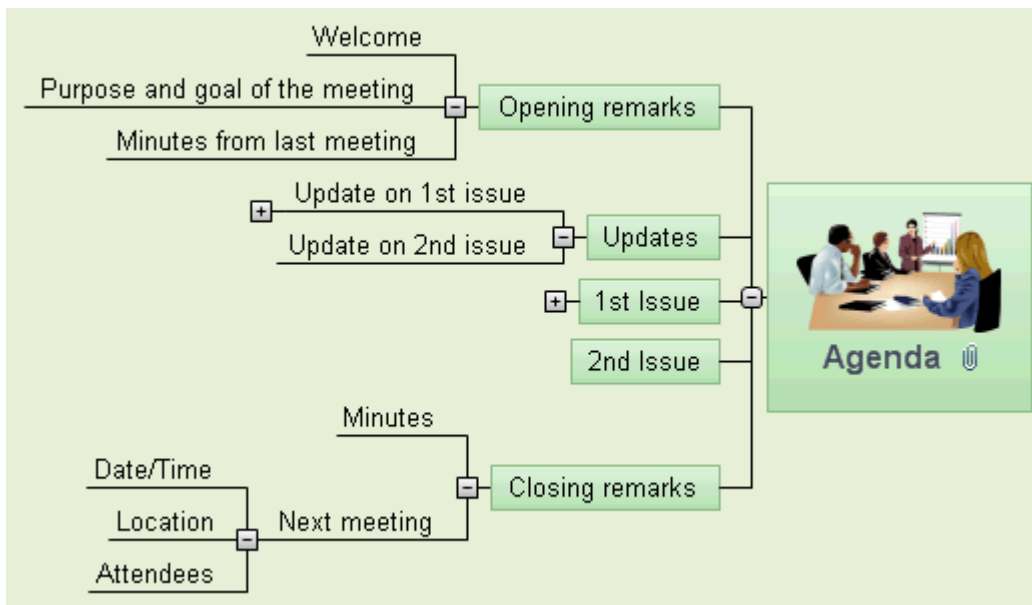

## Timeline view

### Using the Timeline view



The Timeline view displays all the branches of your document that contain time information in chronological order along a horizontal time axis. The different timescales available (standard, historic, geological, daily and weekly) let you represent a variety of different events, such as the planning of a product launch, the life cycle of a bee or the rise and fall of an ancient civilization.



The date formats you see in MindView will depend on your computer's settings.

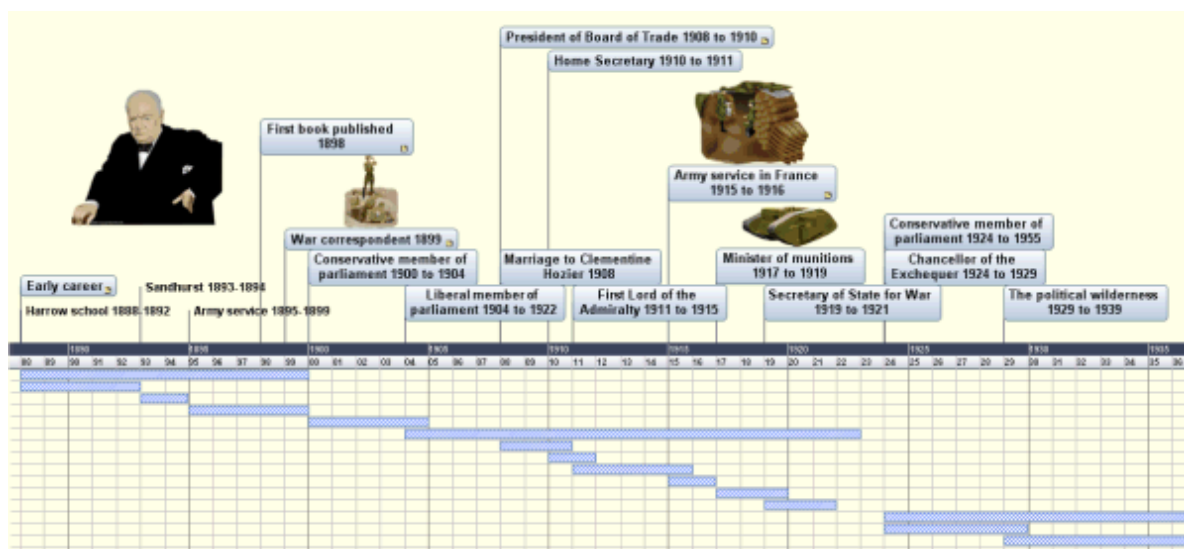

### Accessing the Timeline view

You can access the Timeline view in different ways:

- To create a new timeline from scratch, click the **File** tab and choose **New | New Timeline**.
- Choose a timescale from your map in the **Select Timescale** dialog that opens. For information about the different timescales available, see "[Inserting timeline data](#)".

You can also display an existing map in timeline form in the Timeline view. To do this:

- Choose **Home | View | Timeline** or **View | View | Timeline** in the main menu, or
- Right-click the workspace and choose **View Map as Timeline** in the local menu, or
- Press **Ctrl + Shift + 4**.

Going to the Timeline view from another view only affects the way the mind map is displayed. The contents of the mind map are not modified, unless you edit them yourself while working in the Timeline view.

### Elements of the Timeline view

As all the other views, the Timeline view is made up of several components:



- **The Timeline Outline**  
This panel, which is displayed by default on the left of the Timeline view, shows all the branches of your map as a hierarchical list which you can expand and collapse as required. All the branches are listed, including those that do not contain time information.



Timeline Outline			
	Branch Name	Start Ti...	End Ti...
	Winston Churchill 1874 - 1965		
	Birth 1874	1874	
	Early career		
	Harrow school 1888-1892	1888	1892
	Sandhurst 1893-1894	1893	1894
	Army service 1895-1899	1895	1899
	First book published 1898	1898	
	War correspondent 1899	1899	
	Capture and escape		
	Conservative member of parliament 1900 to 1904	1900	1904
	Liberal member of parliament 1904 to 1922	1904	1922
	Marriage to Clementine Hozier 1908	1908	
	President of Board of Trade 1908 to 1910	1908	1910
	Home Secretary 1910 to 1911	1910	1911
	First Lord of the Admiralty 1911 to 1915	1911	1915
	Gallipoli		

The Timeline Outline works exactly as the main Outline view.

You can close the Timeline Outline by clicking its Close icon . To re-open it, choose **View | Timeline Outline** in the Timeline Tools tab.

 You can also click the **Auto Hide** pin  to make the Timeline Outline only appear when you hover its tab on the left side of the workspace.

- **The Timeline**

The Timeline area shows all the branches of your map that contain time information, arranged in chronological order along a time axis.

All the branches and sub-branches that contain time information are represented, regardless of the hierarchical structure of the map.

Note that if none of your branches contain time information when you switch to Timeline view, the timeline will be empty.

- **The Task/Timeline Panel**

This panel is displayed on the right of the workspace. It lets you define the timescale of your document and enter time information on its branches.

Both of these operations are described in detail in the topic "[Inserting timeline data](#)".

As well as using the Task/Timeline panel, you can also enter time information for your branches directly in the Timeline Outline or in the main Outline view.

If the Task/Timeline panel is not visible, click the **Task/Timeline** tab on the right of the workspace or choose **View | Show/Hide | Task/Timeline Panel**.

- **The Timeline Tools Tab**

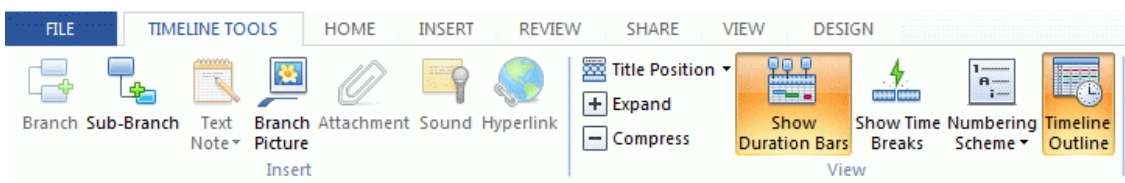

This toolbar appears as soon as you switch to the Timeline view. Its icons allow you to perform various actions on your timeline, as described below.



## Using the Timeline Outline

The Timeline Outline shows all the branches of your map, including those that do not contain time information. The timeline itself however only shows the branches containing time information.

The branches are listed in the Timeline Outline in their order of creation. This means that if you created them in another view such as the Mind Map view, they will be listed in the Timeline Outline in the same order as in the Mind Map view (going clockwise from the top right), rather than in chronological order.

Selecting a branch in the Timeline Outline automatically selects it on the timeline. If necessary, the timeline is scrolled to bring the branch into view. Conversely, selecting a branch on the timeline selects it in the Timeline Outline.

The Timeline Outline looks and works exactly as the main Outline view. When working in the Timeline Outline, you can for instance:

- Add, delete, move, cut, copy and paste branches in exactly the same way as in the main Outline view.
- Add branch pictures, icons, text notes and pop-up comments to any of your tasks.
- Attach objects such as text files, video files, sound files, hyperlinks and so on.

For a description of the Outline view and how to perform these operations, see "[Using the Outline view](#)".

You can enter time information on a branch from the Timeline Outline by double-clicking the relevant Start Time or End Time cell (or pressing **F12** or **Ctrl + F12** respectively) and filling in the time picker as described in "[Inserting timeline data](#)".

Any change you make in the Timeline Outline is immediately reflected on the timeline itself.

## Using the Timeline

By default, the timeline shows all the branches of your map that contain time information arranged in chronological order along a time axis.

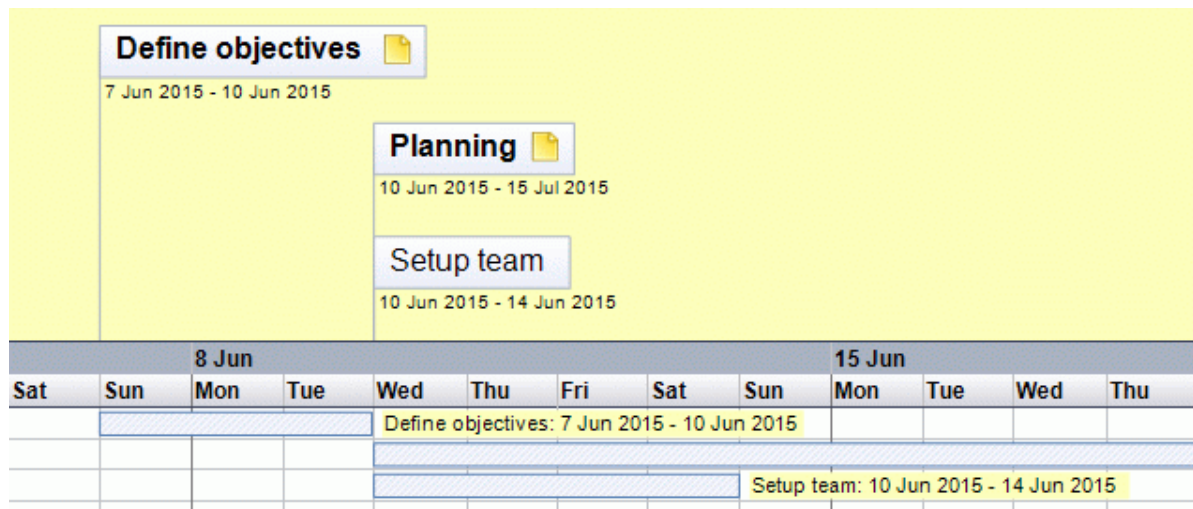

## Choosing a layout and style

MindView lets you define the visual aspect of your timeline at any time by applying design options to it.

- Click the **Design** tab at the right of the ribbon.
- Browse through the **Layouts** gallery to choose your preferred layout.
- Browse through the **Styles** gallery to choose your preferred style.
- (optional) To further customize the visual aspect of your timeline, explore the options available in the **Effects** and **Properties** panels.

### Inserting branches

As well as using the Timeline Outline, you can enter events (branches) directly on the timeline itself:

- Double-click the workspace.
- Fill in the relevant details in the **Insert Event** dialog and click OK.

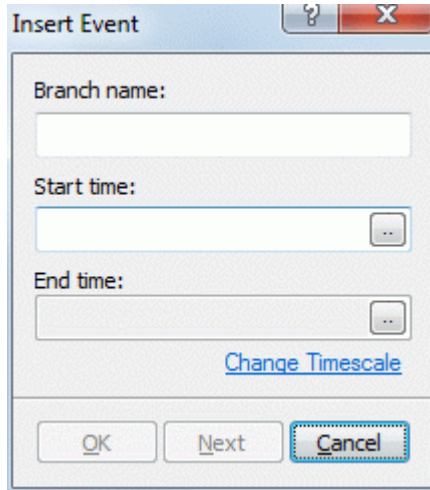



The branch is now inserted at the correct place in the timeline.

 Clicking *Next* instead of *OK* keeps the dialog open, ready for you to insert more branches.

### Moving branches

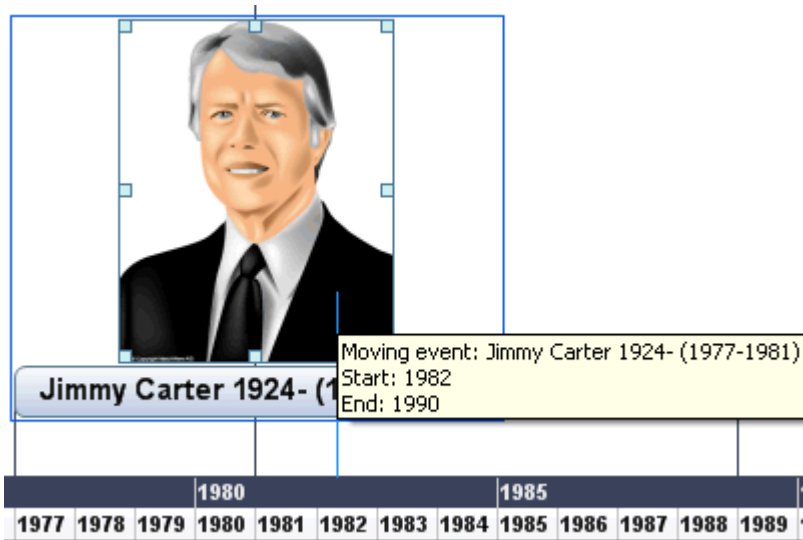
MindView also lets you move branches on the timeline by dragging them to a different start time. Note that if an end time had been specified for the branch, this end time is also moved so that the duration remains the same.



 For more precise positioning, double-click the relevant *Start Time* or *End Time* cell in the *Timeline Outline* (or press **F12** or **Ctrl + F12** respectively) to open the time picker.

### Adding objects and elements

When working in the Timeline view, you can add icons, pictures, text notes, comments and branch connections on any of the branches displayed in the timeline, just as in all the other views. You can also attach objects such as text files, video files, sound files and hyperlinks.

- Select the required branch on the timeline.
- Choose the relevant command, using either the main menu or the local menu of the branch.

For more information on these procedures, see the topics "[Inserting icons](#)", "[Inserting pictures](#)", "[Inserting text notes](#)", "[Inserting comments](#)", "[Attaching objects](#)", "[Creating hyperlinks](#)" and "[Creating branch connections](#)".





## Viewing the Timeline

### Viewing the events

- To display the start and end times of the timeline events underneath their label, choose **View | Data | Show Branch Data**  (or right-click the workspace and choose **Show Branch Data**) and check **Start/End time** in the sub-menu.



*You can then hide or show the time information on individual branches with the **Show Branch Data** icon of the Format tab (or the **Show Branch Data** option in the branch local menu).*

- If you have entered both a start time and an end time for a particular event, you can show the duration of this event as a bar below the time axis by clicking **View | Show Duration Bars** in the Timeline Tools tab.
- You can view pop-up comments and attached objects by clicking the comment icon  or paperclip icon  just as in the other views.
- The **Numbering Scheme** icon  of the Timeline Tools tab or Home tab lets you apply sequential numbers to the branches of the Timeline according to their order in the Timeline Outline. When your timeline has several levels of branches, it will help you identify which main branch the different sub-branches belong to.
- As in the other views, you can also use the **Apply Branch Focus** icon  of the View tab to restrict the display to a particular branch. Click the **Clear Branch Focus** icon  to view the entire timeline again.



*If the branch you selected does not have any sub-branches, or if its sub-branches do not contain time information, the timeline will be empty.*



For more information about this procedure, see the topic "[Focusing on a branch](#)" of the "Further tasks" section.

- Finally the **Filter** icon  of the View tab lets you hide all the timeline branches that do not meet the filter criteria you have defined.

For more information about this procedure, see the topic "[Filtering a mind map](#)" of the "Further tasks" section.

### Zooming in and out

You can change the level of magnification of your entire timeline as follows:

- Click the **Zoom In** icon  of the Zoom slider shown in the bottom right of the workspace (or press **Ctrl + "+"**) to increase the level of magnification of your timeline.  
When you zoom in, everything gets bigger, including the text, the boxes and the pictures included on your timeline.
- Click the **Zoom Out** icon  (or press **Ctrl + "-"**) to decrease it.  
When you zoom out everything gets smaller.
- Choose **View | Zoom | Fit All**  or press **F4** to see the entire timeline.

You can also view your timeline in full screen mode, to give it as much screen space as possible:

- Choose **View | Zoom | Full Screen**  or press **F9**.
- To return to normal viewing mode, choose **Close Full Screen** in the floating Full Screen toolbar, press **Esc** or press **F9** again.

See "[Zooming in and out](#)" for more information on zooming.

### Expanding and compressing

You can also increase or decrease the level of detail on the time axis as follows:

- To increase the scale on the time axis, click **View | Expand** in the Timeline Tools tab.
- To decrease the scale, click **View | Compress**.

Expanding the scale makes the timeline less crowded as a given period of time occupies more horizontal space. As a result, you may start seeing more detail on the time axis. For instance, instead of having ticks every 5 years, you might now have a tick for every year. As you continue expanding the scale, you might see months and days appear on the time axis.

Events on the timeline do not change size when you expand the scale: they move apart horizontally, and they may also move vertically nearer the time axis as more space becomes available. Contracting the scale has the reverse effect.

### Inserting time breaks

You can also replace empty space on the time axis with one or more break marks by clicking **View | Show Time Breaks** in the Timeline Tools tab.

This optimizes the use of the horizontal space when events are not evenly distributed along the timeline.

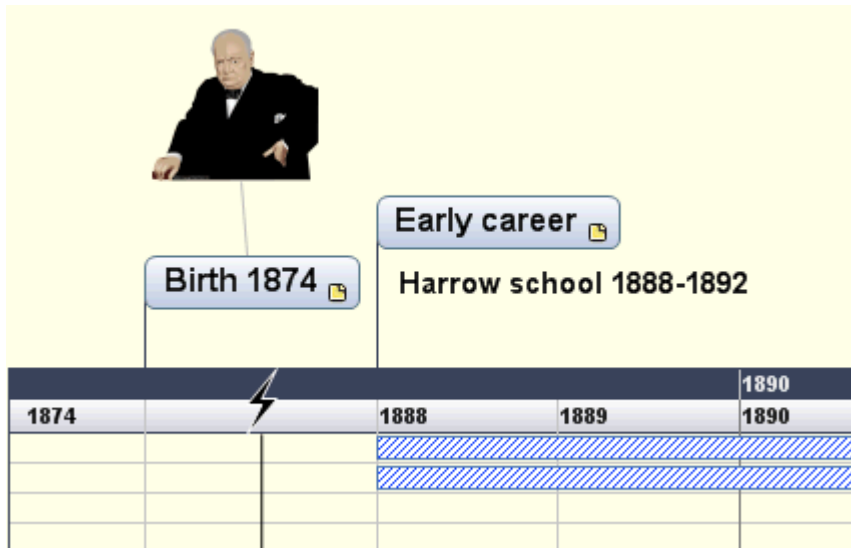

- To remove these time breaks, just click the icon again.

### Exporting the Timeline

When working in the Timeline view, the only export methods available are:

- Export to **HTML**

This export method works in exactly the same way as when you export the document from one of the standard Mind Mapping views. The only difference is that the Home page of your web site contains an interactive view of the timeline, allowing you to display each of its pages with a simple click wherever the mouse pointer changes to a hand. A Timeline button is inserted in all the pages of the site to let you return quickly to this interactive view.

**Define pricing policies**

Define objectives Planning Product-related issues Marketing Sales Training Post-mortem

ProductLaunch > Product-related issues > Define pricing policies

The first step in pricing is to determine the pricing strategy for the product, itself based on our overall market objectives.

Does our product have a substantial competitive advantage? Do we need to gain market share before the price can be increased?

**Strategies to consider:**

- Premium
- Competitive
- Penetration
- Skimming
- etc.

**Discounts to consider:**

- Volume
- Cash payment

For more information about this export method, see "[Exporting to HTML](#)".

- Export to **Microsoft Outlook**

For more information about this export method, see "[Exporting to Microsoft Outlook](#)".

- Export to **Microsoft Project**

For more information about this export method, see "[Exporting to Microsoft Project](#)".

- Export to **XML**

For more information about this export method, see "[Exporting to XML](#)".

- Export to **picture**

For more information about this export method, see "[Exporting as picture](#)".

## Printing the Timeline

You can print your timeline in the same way as in the Map views.

MindView enables you to spread your printout on several pages, which is very useful in the case of timelines. Increasing the horizontal page spread number, for instance, will allow you to create a legible printout of your entire timeline, spread over several pages.

For a full description of the printing options, see "[Printing a mind map](#)".

## Outline view

### Using the Outline view



The Outline view represents the map as a hierarchical list which you can expand and collapse as required. It allows easy navigation through the document from top to bottom and gives you another way to brainstorm ideas.

It is particularly useful when building a task list, as you can view all the task properties in one glance and edit them quickly by clicking the relevant cell.

### Accessing the Outline view

You can access the Outline view in different ways:

- To create a new outline from scratch, click the **File** tab and choose **New | Outline**.

To display an existing map in outline form in the Outline view, you can either:



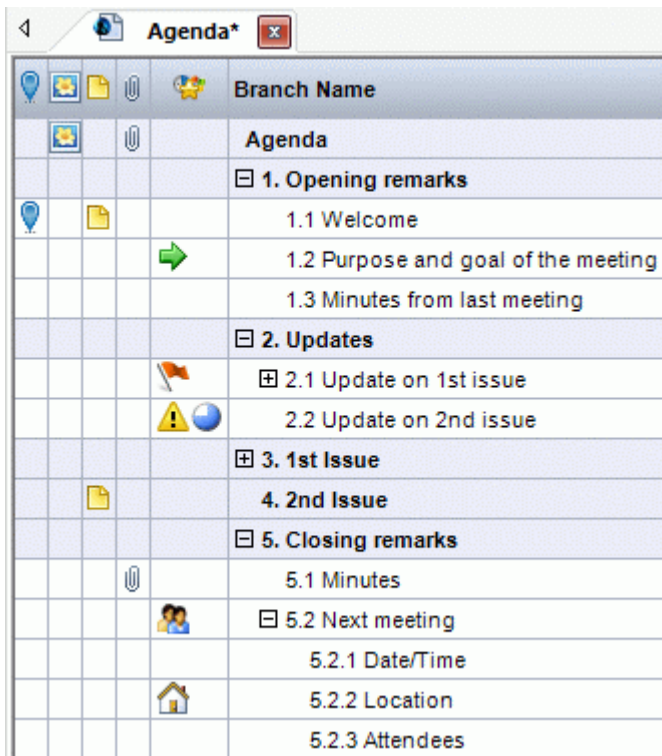

- Choose **Home | View | Outline** or **View | View | Outline** in the main menu, or
- Right-click the workspace and choose **View Map as Outline** in the local menu, or
- Press **Ctrl + Shift + 5**.



Going to the Outline view from another view only affects the way the mind map is displayed. The contents of the mind map are not modified, unless you edit them yourself while working in the Outline view.

### Elements of the Outline view

The Outline view shown above is made up of several columns:

- A **pin icon**  in the first column indicates that the branch has been singled out using the MapNav feature so that you can locate it quickly again within your map. For more information about this feature, see "[Viewing a mind map](#)".
- A **picture icon**  in the next column denotes the presence of a branch picture. Just move the pointer over the icon to see a preview of the picture. Double-click the icon to display the picture in the image viewer associated with its file extension on your computer.
- A **yellow comment icon**  in the next column indicates that the corresponding branch contains a pop-up comment. Just move the pointer over the icon to open the comment window.
- A **paperclip icon**  in the next column indicates that the corresponding branch contains attached objects (text notes, text files, video files and so on) or that it is linked to another branch via a branch connection. To view an attached object, move the pointer over the icon to display the pop-up list of attached objects and click the required object to open it in the associated viewer.
- If you have inserted one or more **icons** on the corresponding branch, these are shown in the last column before the branch name.
- By default, the columns on the right of the view show the **Start** and **End** dates you can associate with the branch to describe a task, as well as its **Priority**, **Completion** level and **Resources**. See "[Inserting task data](#)" for details about these fields.
- If you are working on a project plan, a **Duration** column also appears, as well as columns labeled **Work** and **Cost**. See "[Using the Gantt view](#)" for more information about project plans.
- If you are working on a timeline, the columns on the right of the view show the **Start Time** and **End Time** associated with each timeline event. See "[Inserting timeline data](#)" for details about these fields.

You can hide and show the columns of the Outline view as you wish:

- Click the **Outline Tools** tab.
- Choose **View | Columns**.
- Select or deselect the column headers as required.



You can also right-click the header at the top of the Outline view and select/deselect the column headers as required.

## Using the Outline

### Choosing a color scheme

MindView lets you apply different color schemes to your outline:

- To choose a different color scheme, click the **Design** tab and check the effect produced by the different options of the Color Scheme gallery before clicking your preferred option.

### Inserting a branch

You can **add** and **delete** main branches, pre-branches and sub-branches in the Outline view in just the same way as in the Map views.

### Moving a branch

You can move an entire branch, including any sub-branches and objects attached to it, to a different branch of your outline. As you work on organizing your ideas, you can for instance decide to convert a sub-topic to a main topic by moving the corresponding sub-branch to the root, or allocate a sub-topic to a different main topic by moving the corresponding sub-branch to a different main branch.

- Select the branch you want to move to a different location by clicking it with the left mouse button.
- While keeping the left mouse button down, drag the branch to the required location.

The mouse pointer changes to a different shape to show you where the branch will be inserted when you let go of the mouse button.

In the example below, dropping the "Planning" branch at the position shown in red by the



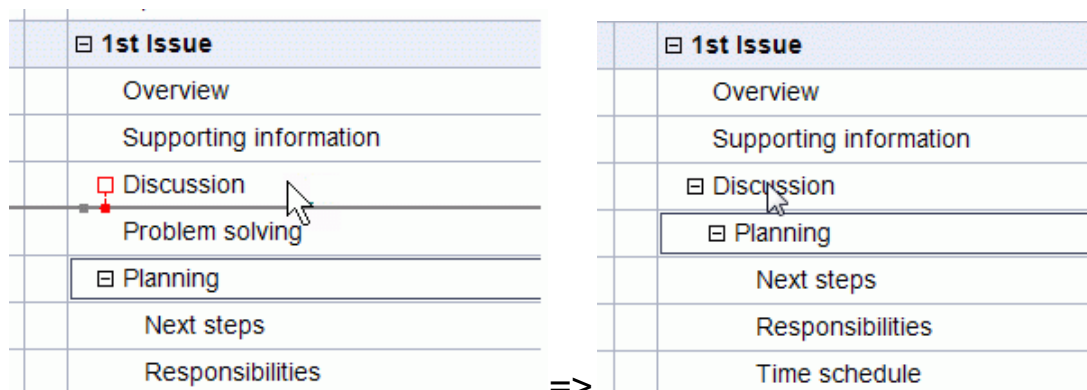

**Move** icon  will make it a sub-branch of the "Discussion" branch.

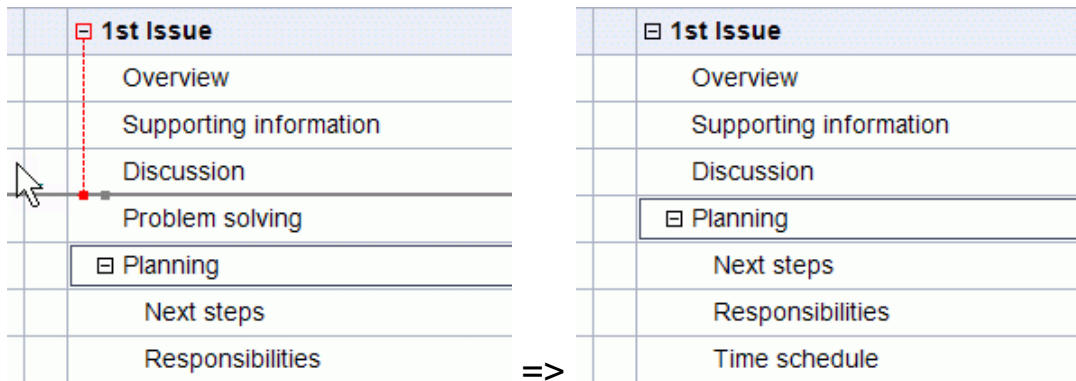

Dragging the "Planning" branch to the left until the Move icon reaches the left dot will keep it at the same hierarchical level (i.e. as sub-branch of "1st Issue") and insert it between "Discussion" and "Problem solving".





- You can also choose the **Indent** icon  of the Outline Tools tab (or press the keys **Alt + Shift + right arrow**) to move the selected branch or branches to the next level down in the hierarchy, so that they become sub-branches of the preceding branch in the Outline.
- Conversely, you can choose the **Outdent** icon  (or press the keys **Alt + Shift + left arrow**) to move the selected branch or branches to the next level up in the hierarchy.
- Finally, you can choose the **Move Up**  and **Move Down**  icons (or press the keys **Ctrl + Up** or **Ctrl + Down**) to move the selected branch up or down within the same level.

### Cutting, copying and pasting branches

You can apply the standard Cut, Copy and Paste functions to any branch or set of branches of your outline, as described in ["Moving a branch"](#). You can for instance copy or move an entire branch or set of branches, including all their sub-branches and attached objects, to a different part of the outline, at the same hierarchical level or at a higher or lower level.

To perform these operations on a set of branches, you first need to select them:

- To select a range of branches listed one after the other, select the first branch, press and hold down the **Shift** key and select the last branch in the range.
- To select several isolated branches, select the first branch, press and hold down the **Ctrl** key and select the other branches one by one.

### Adding objects and elements

You can add branch pictures, icons, text notes and pop-up comments on a branch in the same way as in the Map views. For more information on these procedures, see the topics ["Inserting pictures"](#), ["Inserting icons"](#), ["Inserting text notes"](#) and ["Inserting comments"](#) in the "Basic tasks" section.

You can also attach objects such as text files, video files, sound files, hyperlinks and so on just as in the Map views. For more information, see ["Attaching objects"](#) and ["Creating hyperlinks"](#).

There are however some limitations that apply when you work in the Outline view:



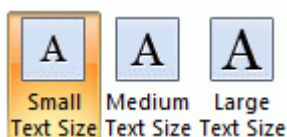

- You cannot add or view floating pictures.
- You cannot add or view floating comments.
- You cannot create branch connections, although existing branch connections are listed in the pop-up list identified by the paperclip icon and can be activated from that list.

### Viewing the Outline

- You can choose the text size to be used in the Outline view by clicking one of the **Text Size** icons of the Outline Tools tab.





- You can show or hide the text notes associated with each branch in the outline itself by choosing **View | Show Text Notes** in the Outline Tools tab. Longer text notes can be scrolled up and down by clicking the small icons  shown at the bottom of the note.

- You can **expand** or **collapse** a particular branch or set of branches by clicking the small plus  and minus  signs on the left of the branch name or by pressing the keys **Ctrl + right** arrow to expand and **Ctrl + left** arrow to collapse.
- The **Numbering Scheme** icon  of the Outline Tools tab or Home tab lets you apply sequential numbers to the branches of the outline and choose between various numbering styles.
- As in all the other views, the **Detail Level** icons  of the View tab let you collapse the entire outline to just one level of branches, two levels, three levels or four levels. To show all the branches down to the last level, click the **All Levels** icon .



*You can also press **Ctrl + 1** to display just one level of branches, **Ctrl + 2** to show two levels etc. **Ctrl + 5** shows all levels.*

- As in the other views, you can use the **Apply Branch Focus** icon  of the View tab to restrict the display to a particular branch. Click the **Clear Branch Focus** icon  to view the entire outline again.

For more information about this procedure, see the topic "[Focusing on a branch](#)" of the "Further tasks" section.

- Finally the **Filter** icon  of the View tab lets you hide all the branches of the outline that do not meet the filter criteria you have defined.

For more information about this procedure, see the topic "[Filtering a mind map](#)" of the "Further tasks" section.

## Printing the Outline

You can print your outline in the same way as in the Map views.

For a full description of the printing options available, see "[Printing a mind map](#)".

## Gantt view

### Using the Gantt view



The MindView Gantt view is dedicated to the creation, editing and management of project plans according to the rules of project management.

A project plan is a series of interdependent tasks that need to be performed in a particular order. When moving into a new office for instance, you cannot start redesigning the office space before the lease agreement has been signed. Project plans have a specific start date, corresponding to the start of the first task (for instance defining the requirements for the new office), and a specific end date, corresponding to the end of the last task (for instance moving in).

Any change in the timing of a task affects all the tasks that depend on it. If a task runs ahead of schedule, MindView automatically recalculates the dates of all the tasks that depend on it in order to take advantage of the time gained. Conversely, if a task is delayed, all the tasks that depend on it are automatically rescheduled, which may or may not impact the overall end date of the project.

In project management, the Gantt chart is the most common and popular way of visualizing a project plan. It shows the tasks as horizontal bars, arranged against a background calendar display. MindView's Gantt view displays the branches of a mind map in this way, each branch or sub-branch representing a project task.



The date formats you see in MindView will depend on your computer's settings. In this documentation we use the most common international format, putting the day first, for example 1-Sept-2012, or 01/09/12.

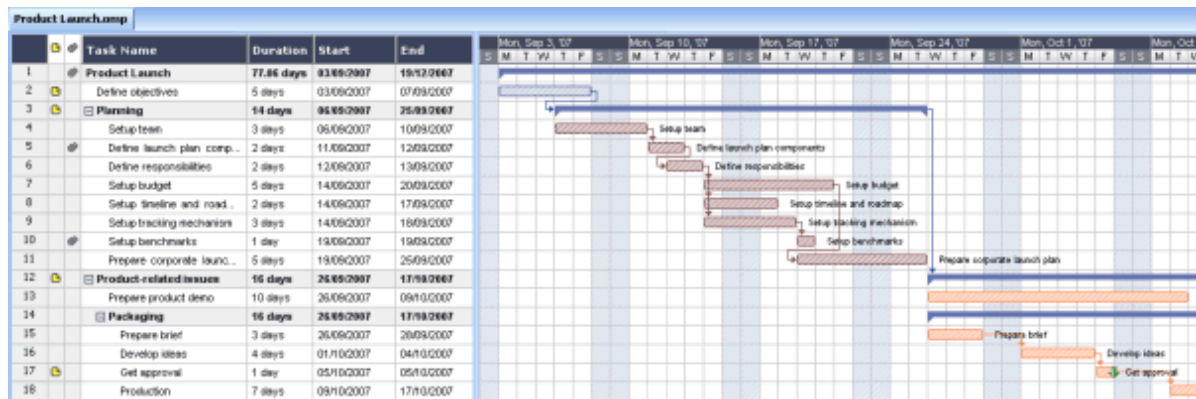

By using the Gantt view you can build and manage complete project plans in this standard, well-defined format. You can easily add or remove tasks, set or adjust the duration of tasks (length of bars), link tasks (for example to make one task follow immediately after another), and add constraints (for example to specify that a task must end no later than a given date).

To help you get started, MindView includes various ready-made project plans for common business activities (organizing a tradeshow, producing a publication, launching a product and so on). You can use these for training purposes, or as a basis for your own project plans.

- To access one of these templates, click the **File** tab, choose **New | New from Template**, and browse through the Business category.

To find out how to set up and build a project plan, see "[Setting up a project plan](#)".

## Accessing the Gantt view

You can access the Gantt view in different ways:

- To create a new Gantt project plan from scratch, click the **File** tab and choose **New | Gantt**.

To display an existing document in the Gantt view, you can either:

- Choose **Home | View | Gantt** or **View | View | Gantt** in the main menu, or
- Right-click the workspace and choose **View Map as Gantt** in the local menu, or
- Press **Ctrl + Shift + 6**.



*Going to the Gantt view automatically converts the document to a Gantt project if this is not the case already. The main consequences of this are:*

- All parent branches become summary tasks: their start dates, end dates and durations are calculated automatically from their sub-tasks and cannot be edited manually any longer. Any existing time information associated with parent branches is lost.
- Tasks are only scheduled during working time, as defined by the project calendars.

Project plans have other important rules regarding links and constraints that are all described in the following topics.

When you are working on a project plan, these project management rules apply even if you switch temporarily to another view than the Gantt view, for instance to brainstorm your plan in one of the Mind Mapping views, or to view it as a timeline in the Timeline view. This means that any change you make to the project plan tasks while in one of these other views will obey project management rules.

## Elements of the Gantt view

As all the other views, the Gantt view is made up of several components:

- The **Gantt Outline**

This area, shown on the left of the Gantt view, presents all your project tasks as a hierarchical list which you can expand and collapse as required.

The tasks are listed in creation order, which means that if you created them in a different view such as the Mind Map view, they will be listed in the Gantt Outline in the same order as in the Mind Map view (going clockwise from the top right), rather than in chronological order.

- The **Gantt Chart**

The Gantt chart, shown on the right of the view, represents each project task graphically as a bar stretching from its start date to its end date. Week-ends and other non-working days are denoted by a hash pattern. Task relationships are represented by links joining the related tasks.

- The **Task/Timeline Panel**

This panel is displayed on the right of the workspace. It gives you an alternative way of specifying task data such as duration, priority, completion level or resources.

The Task/Timeline panel is described in detail in the topic "[Inserting task data](#)".



If it is not visible, click the **Task/Timeline** tab on the right of the workspace or choose **View | Show/Hide | Task/Timeline Panel**.



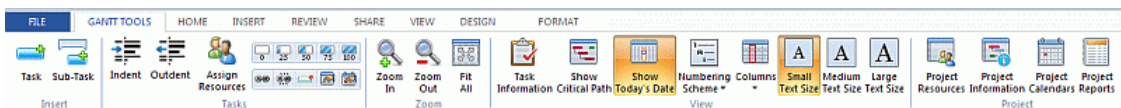

- The **Gantt Tools Tab**





This toolbar appears as soon as you switch to the Gantt view. Its icons allow you to perform various actions on your project tasks, as described in the next few topics.

## Using the Gantt Outline

The Gantt Outline is made up of several columns. Some of these only appear if one or more of the project tasks contains the corresponding element:

- The first column is the **Entry** column. It shows the unique entry number automatically allocated to each task. The entry numbers do not necessarily represent the order in which the tasks will be performed.
- A **pin** icon  in the next column indicates that the branch has been singled out using the MapNav feature so that you can locate it quickly again within your map. For more information about this feature, see "[Viewing a mind map](#)".
- A **picture** icon  in the next column denotes the presence of a branch picture. Just move the pointer over the icon to see a preview of the picture. Double-click the icon to display the picture in the image viewer associated with its file extension on your computer.
- A **yellow comment** icon  in the next column indicates that the corresponding task contains a pop-up comment. Just move the pointer over the icon to open the comment window.
- A **paperclip** icon  in the next column indicates that the corresponding task contains attached objects (text notes, text files, video files and so on) or that it is linked to another task via a branch connection. To view an attached object, move the pointer over the icon to display the pop-up list of attached objects and click the required object to open it in the associated viewer.
- If you have inserted one or more **icons** on the corresponding branch, these are shown in the next column.

The Gantt Outline also contains columns that are specific to project management:

- **Indicators:** If you have applied a constraint to a task, for example to specify that it must end no later than a given date, a constraint icon  is displayed in the column immediately before the Task Name column. Constraints are described in detail in "[Using Constraints](#)".  
If you have made a task inactive to prevent it from affecting the scheduling of the project, the  is displayed in this column. For more information about inactive tasks, see "[Making a task inactive](#)" in the topic "[Enhancing a project plan](#)".
- **Task Name:** The name of each task. Tasks that contain one or more sub-tasks are shown in bold. These tasks (which correspond to parent branches in the Mind Map view) are called "summary tasks". Ordinary tasks (corresponding to branches without sub-branches in the Mind

Map view) are shown in normal typeface and indented according to their level. See the paragraph "[Grouping tasks](#)" in "[Entering and editing tasks](#)".

- **Duration:** The amount of working time the task will take. Time units are indicated by letters: mins (minutes), hrs (hours), days, wks (weeks), mths (months). The letter **e** before the time unit indicates elapsed time, in which case the task will last exactly the time specified, regardless of what the project calendar defines as working and non-working time. A question mark means that the figure is still an estimate. By default, MindView assigns a duration of one day to new tasks or tasks without specified duration. For more information about calendars, see "[Defining calendars](#)".

The task bar of a summary task is automatically set to extend from the beginning of the earliest of its sub-tasks to the end of the last of its sub-tasks. You cannot change the duration of a summary task.



When expressed in days, weeks or months, the number shown in the Duration column (for instance "2 days") is linked to the default number of working hours per day, week or month set in the Project Calendars Settings dialog (choose **Gantt Tools | Project | Project Calendars**).

For more information about durations, see "[Entering a task duration](#)" in the topic "[Entering and editing tasks](#)".

- **Start:** The current start date of the task. By default, MindView schedules new tasks to start on the project start date, as defined in the Project Information dialog (choose **Gantt Tools | Project | Project Information**).

Although you can set start dates explicitly, it is best to let MindView set them automatically according to the dependencies between the various tasks. See "[Specifying start and end dates](#)" in the topic "[Entering and editing tasks](#)" for more information.

The start date of a summary task is automatically set to be the start date of the earliest of its sub-tasks.

- **End:** The current end date of the task. MindView calculates the end date for a task from its start date and its duration, paying attention to the working and non-working time specified by the project calendar. Unless the duration is specified as "elapsed", MindView only schedules tasks during working time. For more information about calendars, see "[Defining calendars](#)".

Although you can set end dates explicitly, it is best to let MindView set them automatically according to the dependencies between the various tasks.

The end date of a summary task is automatically set to be the end date of the last of its sub-tasks.

- **Predecessors:** If a task is linked to one or more earlier (predecessor) tasks, this column shows the entry numbers of those earlier tasks. Task entry numbers are shown in the first column. See "[Using links](#)" for more information on task dependencies.
- **Completion:** The completion level of the task.
- **Priority:** The priority level of the task.
- **Resources:** If you have assigned resources to a task, they are listed in this column. See "[Assigning resources](#)".
- **Work:** If you have assigned resources to a task, this column shows the overall work value for the task. See "[Assigning resources](#)".
- **Cost:** If you have assigned resources to a task and associated a cost with these resources, this column shows the overall cost of the resources that have been allocated to the task. See "[Assigning resources](#)".

You can hide and show the columns of the Gantt Outline as you wish:

- Click the **Gantt Tools** tab.
- Choose **View | Columns**.
- Select or deselect the column headers as required.





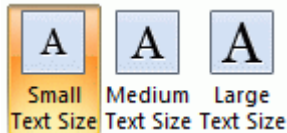

You can also right-click the header at the top of the Gantt Outline view and select/deselect the column headers as required.

The Gantt Outline works exactly as the main Outline view. When working in the Gantt Outline, you can for instance:

- Add, delete, move, cut, copy and paste tasks in exactly the same way as in the main Outline view.
- Add branch pictures, icons, text notes and pop-up comments to any of your branches.
- Attach objects such as text files, video files, sound files, hyperlinks and so on.
- Choose the text size to be used by clicking one of the **Text Size** icons of the Gantt Tools tab.





- Use the **Numbering Scheme** icon  of the Gantt Tools tab or Home tab to apply sequential numbers to the tasks and choose between various numbering styles.
- Use the **Detail Level** icons  of the View tab to determine how many levels of tasks should be visible.
- Use the **Apply Branch Focus** icon  of the View tab to restrict the display to a particular task and click the **Clear Branch Focus** icon  to view the entire project plan again.
- Use the **Filter** icon  of the View tab to hide all the tasks that do not meet the filter criteria you have defined.

For details on how to perform these operations, see "[Using the Outline view](#)".

### Viewing the Gantt Chart

You can manipulate the timescale shown at the top of the Gantt chart to view your tasks with more or less detail as follows:

- Click the **Zoom In** icon  of the Gantt Tools tab (or press **Ctrl + "+"**) to view your schedule in more detail, going for instance from a Months/Weeks combination to a Days/Hours combination.
- Click the **Zoom Out** icon  (or press **Ctrl + "-"**) to show larger increments of time, going for instance from a Months/Weeks combination to a Years/Quarters combination.
- Choose **Fit All**  or press **F4** to let MindView choose the level of detail that allows the entire project plan to fit on the chart.

You can also view your chart in full screen mode, to give it as much screen space as possible:

- Choose **View | Zoom | Full Screen**  or press **F9**.
- To return to normal viewing mode, choose **Close Full Screen** in the floating Full Screen toolbar, press **Esc** or press **F9** again.

You can also choose from a wider variety of combinations of calendar headings as follows:

- Double-click the headings (tiers) at the top of the calendar display to open the **Gantt Timescale** dialog.



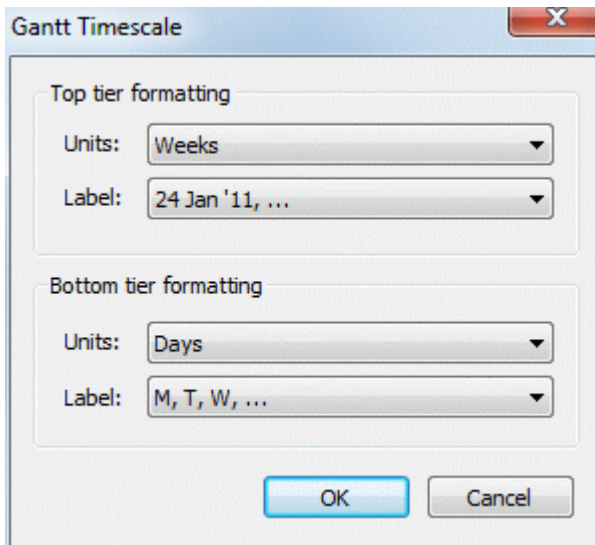



- Choose a unit and a label for the **top tier** (the top heading).
- Choose a unit and a label for the **bottom tier** (the bottom heading).

Note that the choices offered for the bottom tier depend on your choice of top tier.

If the task you want to view falls outside the time range shown on the Gantt chart, you can reveal that part of the project plan to view the relevant task bar as follows:

- Select the task in the Gantt Outline and click the **Go to Selected Task** icon  on the Gantt Tools tab.

 To view the Gantt chart from the current date onwards, click the **Go to Today's Date** icon  on the Gantt Tools tab.

## Customizing the Gantt Chart

MindView lets you define the visual aspect of your overall Gantt, as well as customize the display of individual task bars.

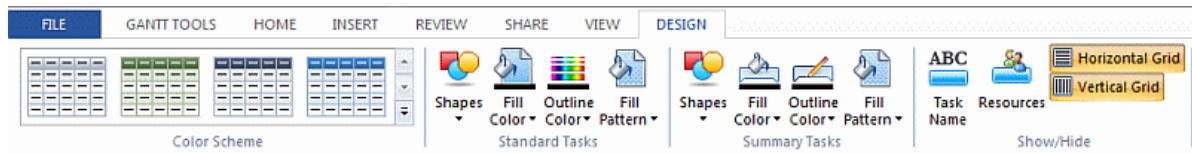

### Customizing the overall display

- To choose a different color scheme for the entire chart, click the **Design** tab and check the effect produced by the different options of the Color Scheme gallery before clicking your preferred option.

The Design tab also lets you apply other global effects to the Gantt chart:

- To display the task name and/or the resources names after the task bars, check **Show/Hide Task Name** and/or **Show/Hide Resources**.
- The **Horizontal Grid** and **Vertical Grid** option let you switch the horizontal and vertical grid lines of the Gantt chart on and off.
- To display a vertical line identifying the current date on the Gantt chart, click **View | Show Today's Date** on the **Gantt Tools** tab.

 You can change the color of this line in the Properties dialog. See "[View properties: General tab](#)" for more information.

- Finally, you can also change the color used to identify the tasks lying on the critical path (**View | Show Critical Path** in the **Gantt Tools** tab) in that same Properties dialog.



### Customizing the task bars

The Design tab also lets you modify the **shape**, **fill color**, **outline color** and **fill pattern** of both summary task bars and standard task bars in one operation:

- Click the **Design** tab at the right of the ribbon.
- Browse through the options shown in the Standard Tasks and Summary Tasks panels to choose your preferred style.

If you need to distinguish some tasks from others, you can also customize them individually:

- Select the task(s) to customize.
- Click the **Format** tab and choose the relevant options.

If necessary, you can undo your changes and return the task bar to the original style defined in the Design tab by choosing **Reset Style**.

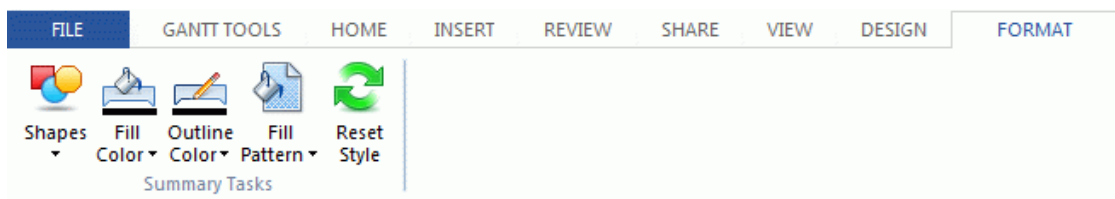

If you have chosen to display the task name and/or the resource names after the task bars, you can set different colors for these labels by using the Properties dialog.

For other ways of customizing the representation of your project plan on the Gantt chart, see "[Enhancing a project plan](#)".

### Setting up a project plan

These are the typical steps you should follow when setting up, building, managing and revising a project plan.

- (optional) Start by brainstorming all the tasks that make up your project plan in one of the standard Mind Mapping views (Mind Map, Top Down or Left/Right), using the Task/Timeline panel to enter preliminary task data.
- Define the project settings, such as its start date, end date and scheduling mode. For more information, see "[Defining the global project settings](#)".
- (optional) Define the project calendar. You may be able to bypass this step if you have already set up appropriate calendar defaults. See "[Defining calendars](#)" for more information.
- (optional) Create the global resources list. Although MindView lets you define the resources as you need them, it is usually quicker to start by setting up a global resources list from which you can then select resources to assign to the various project tasks. See "[Assigning resources](#)" for details.
- Enter or edit task names and durations. See "[Entering and editing tasks](#)".
- Assign resources to tasks. See "[Assigning resources](#)".
- Create links to specify the dependencies between the project tasks. See "[Using links](#)".
- Set constraints on the tasks as necessary. See "[Using constraints](#)".
- Make final adjustments to the project plan. See "[Enhancing a project plan](#)".
- Once the project has actually started, inspect it at regular intervals to detect potential problems or scheduling conflicts and make any corrections required. See "[Reviewing a project plan](#)".
- (optional) If you need to expand your project plan further, you can easily export it to Microsoft Project to take advantage of the advanced project management capabilities of this application. For more information, see "[Exporting to Microsoft Project](#)".
- You can also create various HTML reports from your project plan, export it to Microsoft Outlook as a series of tasks or export it in XML format. For more information, see "[Creating project reports](#)" and "[Exporting a project plan](#)".

## Defining the global project settings



Before doing detailed scheduling work on the tasks of your project plan, it is worth considering its global settings, such as its start date and scheduling mode.

- To view these settings, choose **Project | Project Information** on the **Gantt Tools** tab.

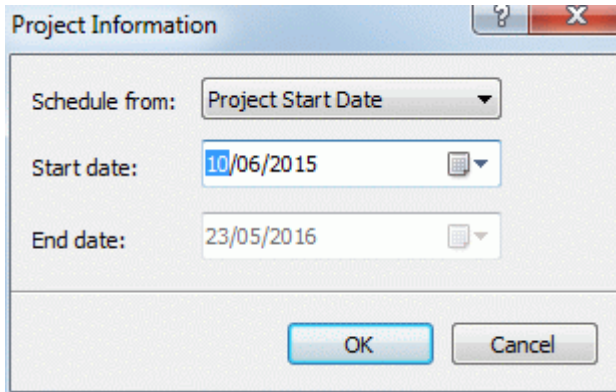

This dialog contains general project information which is important in determining how the project tasks are scheduled.

**Schedule from:** Defines the scheduling mode for your project. The most common way of setting up a project is to schedule it from its start date. In this mode the default is for tasks to start as soon as possible, which means that the whole project finishes at the earliest possible date. When you plan backwards from the project end date, tasks are scheduled to start as late as possible so that the whole project finishes on the specified end date. Planning from the end date is not recommended as it does not allow any slack time between tasks. Even when you have a specific deadline for your project, planning from the start date is the most flexible approach as it ensures that each task is completed at the earliest possible date, leaving as much slack time as possible to deal with unplanned problems or delays.

**Start date:** Specifies the first day of the first task. By default, this field is set to today's date. If your project is due to start sometime in the future or if you are planning a project that has in fact already started, indicate the start date of the project in this field.

By default, all the tasks you create will be scheduled to start on the project start date, unless you assign specific timings to them or link them to other tasks.

If you are scheduling from the start date, MindView calculates the project end date automatically, based on the duration of the project tasks, their relationships, and the project calendar.

**End date:** Specifies the last day of the last task. If you are scheduling from the end date, MindView calculates the start date automatically, also by taking into consideration the duration of the project tasks, their relationships, and the project calendar.

## Defining calendars



Calendars and calendar settings provide the basic information about working and non-working time that MindView uses to schedule the tasks of a project plan. MindView does not allow work to happen on non-working days or at non-working times.

There are three types of calendar:

- **The default calendar**  
The default calendar provides the initial settings for any new MindView project you create. By editing these defaults to values reflecting your company's normal working days and times, you can minimize the changes needed when you create a new project plan.
- **The project calendar**  
Each project plan has its own project calendar. The settings it contains affect the way MindView schedules the project tasks. To start with, when you create a new file, the project calendar is identical to the default calendar.

The project calendar is saved with the rest of the project properties whenever you save the file.

- The **resource calendars**

These control the working and non-working time of the resources working on the project. Each resource has its own calendar. By default, they are identical to the project calendar.

Any changes you make to the project calendar are automatically transferred to all the resource calendars. However, specific changes you might have made to the working time of a particular resource are preserved.

For more about resources and resource availability, see "[Assigning resources](#)".

## Editing the default and project calendars

You can edit either calendar together with the relevant settings:

- To edit the **default calendar**, click the **File** tab, click **MindView Options** in the bottom right of the dialog and open the **Calendar** panel. Changes you make here only affect the initial settings for new files; they do not affect existing files.
- To edit the **project calendar**, choose **Project | Project Calendars** on the **Gantt Tools** tab. Changes you make here only affect the current file.

The two dialogs are almost identical: all the options are described below, but only the project calendar dialogs are illustrated.

### Defining the calendar settings

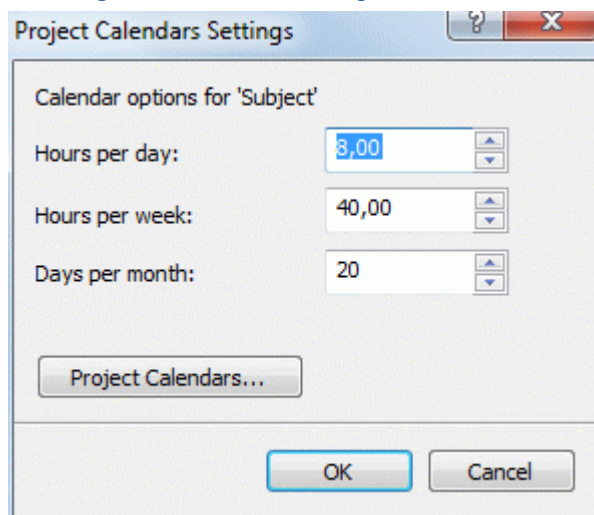

**Hours per day:** Defines the number of working hours in a standard working day, for example 8. You can enter the value as a decimal number (e.g. enter 7.5 to specify 7 hours and 30 minutes). MindView uses this value to calculate task durations that are specified in days.

**Advanced notes:** This setting and the next two settings determine the amount of working time that MindView allocates to a task when you specify a duration in days, weeks or months.

When you enter durations, MindView always converts them to minutes and that is the number it stores behind the scenes. MindView uses standard values to convert hours to minutes: one hour equals 60 minutes. However when you specify a duration in days, weeks or months (provided you have not specified "e" for elapsed) MindView uses the number of working hours per day, week or month defined here to calculate the corresponding number of minutes to store.

From the working days and working times allowed by the project calendar it then works out the number of days required for the task and calculate its end date. For this reason, it is a good idea to make sure that the values you choose here match the working time allowed by the calendar as closely as possible, as it will make the entries in the Duration column of the Gantt Outline match the lengths of the task bars more closely.

Redefining these settings after having entered tasks does not alter their real durations (since they are stored in minutes) or the lengths of the task bars (since the amount of work has not changed), but the numbers for days, weeks and months in the Duration column will change.

For more information about durations, start dates and end dates, see "[Entering and editing tasks](#)".

**Hours per week:** Defines the number of working hours in a standard working week, for example 40. You can enter the value as a decimal number. MindView uses this value to calculate task durations that are specified in weeks.

**Days per month:** Defines the number of working days in a standard working month, for example 20. Enter a whole number value. MindView uses this value to calculate task durations that are specified in months.

**Modifying the calendars**

- Click **Project Calendars** in the Project Calendars Settings dialog to access the calendar itself (or **Default Calendar** in the **Calendar** panel of the **MindView Options** if you are viewing the default calendar settings).

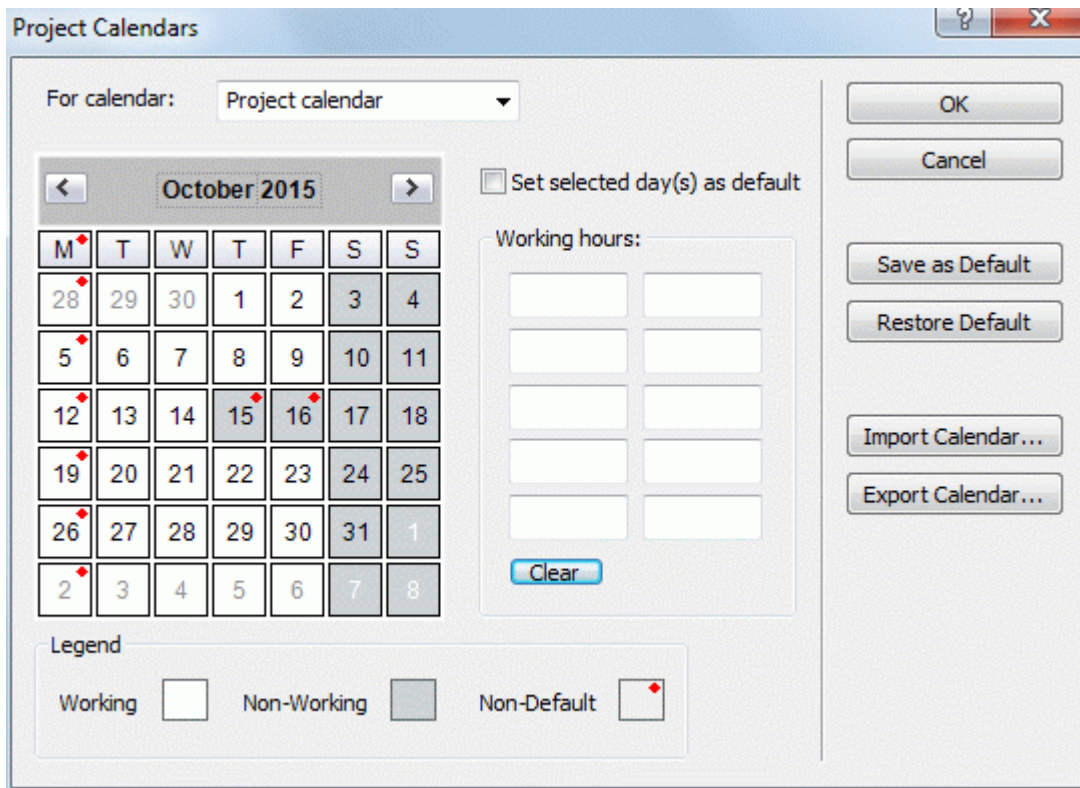

Working days are shown in white and non-working days are shown in grey.

- In the project calendar, a red dot on a particular day indicate that the working hours for that day are different from those set in the default calendar.
- In the default calendar, a red dot indicates that you have made a change to the working hours of that day since opening the dialog. These red dots disappear as soon as you save the default calendar.

Note that the distribution of red dots in your project calendars may change if you edit the default calendar. This does not mean that your project plans have changed, only that the differences between the default and project calendars have changed.

- To see the working hours for a particular day, select the day by clicking it.

The working hours appear in the boxes on the right of the calendar grid.

*Displaying a particular day*

If the day you want to examine is not currently visible on the calendar grid, you can browse to it in several ways by using the calendar header:

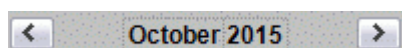

- Click the arrows placed on each side of the header until the correct month and year appear.
- Click the year on the header and use the up and down arrows to reach the correct year.
- Click the month name on the header and choose the correct month in the drop-down list.

### *Selecting one or more days*

To change the working times defined by the calendar, start by selecting the day or days to be modified:

- To select one day only, just click it.
- To select several contiguous days, select the first day and drag the mouse until the last day in the range. You can also select the first day, press the Shift key and click the last day in the range.
- To select several non-contiguous days, select the first day and press the Ctrl key while selecting all the other days.
- To select all Fridays (for example), click F in the column header. This selection applies to the whole duration of the project, not just the displayed month. You can select several columns by Shift- or Ctrl-clicking them.

### *Editing one or more days*

- Select one or more days as described above.

If you select several days with different working hours, the boxes on the right show the working hours of the earliest day in the range.

You can now make changes:

- To change the working hours, enter new values in the boxes on the right.
- To make the day(s) non-working, click Clear to delete the time entries from the boxes.
- To reset the working times to the default calendar values, select "Set selected days as default".

### *Saving and restoring defaults*

- To save the current project calendar as the new default calendar, open the **Project Calendars** dialog and click **Save as Default**. Your existing default calendar will be overwritten.
- To return all project calendar settings to those of the default calendar, open the **Project Calendars** dialog and click **Restore Default**.

You can return the default calendar to the original MindView settings as follows:

- Open the **Default Calendar** dialog (click the **File** tab, click **MindView Options** and open the **Calendar** panel).
- Click **Import Calendar**.
- Browse to:  
C:\Program Files\MatchWare\MindView 5.0\UserData\Gantt
- Select the file **defaultcal.xml**.  
Your current default calendar is overwritten with the original MindView default calendar.
- Click **Save** from the Default Calendar dialog to save the restored default calendar.

### *Importing and exporting calendars*

You can also import calendars from other projects or export your calendars for use by colleagues.

- To import a previously saved MindView calendar, click **Import Calendar**. Existing settings will be overwritten.



*You can also import the calendar of an existing Microsoft Project document by exporting that document to XML from Microsoft Project, then choosing the exported XML document in this dialog.*



- To export your current calendar for use on a different project for instance, click **Export Calendar**.



When exported, the MindView calendar is saved the MindView XML format.

### Editing resource calendars





- Use the drop-down list at the top of the **Project Calendars** dialog to select the calendar of the resource you want to edit.
- Make the changes required. The steps to follow to edit a resource calendar are exactly the same as for the project calendar.

For more about resources and resource availability, see "[Assigning resources](#)".

### Entering and editing tasks



When working in the Gantt view, you can use the Gantt Outline to work on tasks exactly as in the main Outline view. You can for instance:

- Add, delete, move, cut, copy and paste tasks as in the main Outline view.
- Add branch pictures, icons, text notes and pop-up comments to any of your tasks.
- Attach objects such as text files, video files, sound files, hyperlinks and so on.
- Use the **Numbering Scheme** icon  of the Gantt Tools tab or Home tab to apply sequential numbers to the tasks and choose between various numbering styles.
- Use the **Detail Level** icons  of the View tab to determine how many levels of tasks should be visible.
- Use the **Apply Branch Focus** icon  of the View tab to restrict the display to a particular task and click the **Clear Branch Focus** icon  to view the entire project plan again.
- Use the **Filter** icon  of the View tab to hide all the tasks that do not meet the filter criteria you have defined.

For details on how to perform these operations, see "[Using the Outline view](#)".



You can also create the tasks of your project plan in other ways:

- By importing a task list from Microsoft Outlook and converting it to a project plan.  
For more information on the import procedure, see "[Importing from Microsoft Outlook](#)".
- By importing a project from Microsoft Project, either directly or via the Microsoft Project XML format.  
For more information, see "[Importing from Microsoft Project](#)" and "[Importing from XML](#)".
- By copying a list of tasks from an external application such as Microsoft Excel, Microsoft Word or Microsoft Project and pasting it into the Gantt Outline.



By default, all the tasks you create in a Gantt project with MindView are given the scheduling task type **Fixed Units**. For more information about task types, see "[Using scheduling task types](#)".

### Entering a task duration

By default, tasks have a duration of one day and are marked with a question mark, to indicate that the duration is only an estimate. As soon as you edit the duration, the question mark disappears. You can modify the duration of a task in various ways:

- On the Gantt chart, position the cursor at the end of the task bar until it changes to **+|+**, and drag the end of the bar to the right or left.
- In the Gantt Outline, type a number of days in the appropriate cell in the **Duration** column. You can follow the number with letter(s) to indicate time units other than days: **m** (minutes), **h** (hours), **d** (days, the default), **w** (weeks), **mo** (months). You can enter the letter **e** before the time unit (for instance "3ed") to indicate elapsed time, in which case the task will last exactly

the time specified, regardless of what the project calendar defines as working and non-working time.

You can indicate that a duration is still an estimate by adding a question mark.

- Select the task and choose **View | Task Information**  on the Gantt Tools tab to open its Task Information dialog. Enter a value in the Duration field as described above.



*You can also open the Task Information dialog by pressing **Shift + F2** or by double-clicking the task bar on the Gantt chart.*

- Select the task and, in the **Task/Timeline** panel, enter a value in the Duration field as described above.

The duration of the task is now indicated on the Gantt chart by a bar extending from its start date to its end date.



At this stage, although the task has a duration, it does not have any work associated with it, because you have not yet assigned any resources to it. Work represents the amount of effort the resource or resources will need to spend on the task to complete it. For more information about work, and the effect of adding resources to tasks, see "[Assigning resources](#)".

**Advanced notes:** When you enter durations, for example "4 hours", MindView converts them to minutes and that is the number it stores behind the scenes. MindView uses standard values to convert hours to minutes: one hour equals 60 minutes. However if you specify a duration in days, weeks or months (provided you have not specified "e" for elapsed) MindView uses the number of working hours per day, week or month set in the Project Calendars Settings dialog (choose Project | Project Calendars on the Gantt Tools tab), to calculate the corresponding number of minutes to store. See "[Defining calendars](#)" for more information about these settings.

While durations determine the amount of working time that you allocate to a task, the length of the task bar indicates how long the task will actually take. These are not necessarily the same. For example, because MindView does not schedule work on non-working days, any task bar spanning a week-end is automatically lengthened to take account of this. Similarly, if your working day is specified as having 8 hours, but the relevant section of the calendar restricts work to only 4 hours a day, a task with a duration of one day (8 hours) will actually take two days (4 hours each day) to complete.

The labels shown in the Duration column, for example "2 days", are calculated from the stored number of minutes for each task. For durations initially specified in days, weeks or months MindView uses once more the number of working hours per day, week or month set in the Project Calendars Settings dialog to convert the stored number of minutes back to days, weeks or months. Consequently if you redefine the number of working hours in a day, week or month set in that dialog, the numbers in the Duration column will change, but the underlying number of minutes, and consequently the length of the bars, will remain the same.

## Specifying start and end dates



*Although you might be tempted to enter specific start and end dates for your tasks, it is not recommended unless you understand the implications of doing so. A better practice is to link tasks so that they follow on logically from one another, and let MindView calculate the dates automatically. In MindView and similar project management applications, entering an explicit start date is equivalent to setting a 'Start No Earlier Than' constraint. Similarly, entering a specific end date is equivalent to setting a 'Finish No Earlier Than' constraint. Although applying constraints in this way is perfectly legitimate if your tasks must indeed obey these constraints, it is best to avoid them wherever possible as they limit the flexibility of your project plan. For more information on the different types of constraints and their effects, see "[Using Constraints](#)".*

If you must enter a specific start date, you can do so in different ways:

- Move the cursor to the center of the task bar and drag the bar to the new position.
- Click the **Start** entry of the task in the Gantt Outline and type or select a date.
- Select the task. On the **Task/Timeline** panel, select a date in the Start date field.





- Select the task and choose **View | Task Information**  on the Gantt Tools tab to open its Task Information dialog. Select a date in the Start field.

 You can also open the Task Information dialog by pressing **Shift + F2** or by double-clicking the task bar on the Gantt chart.

You can enter an end date in the following ways:

- Click the **End** entry of the task in the Gantt Outline and type or select a date.
- Select the task. On the **Task/Timeline** panel, select a date in the End date field.
- Select the task and choose **View | Task Information**  on the Gantt Tools tab to open its Task Information dialog. Select a date in the End field.

 When you enter a specific start or end date, a constraint icon  appears next to the task name in the Gantt Outline. Hovering this icon with the mouse displays a tooltip with details about the constraint.

To remove the constraint set by entering an explicit start or end date:

- Open the **Task Information** dialog and remove the check mark from the **Constraint date** field.

Constraint type:  Constraint date:  19.09.2016

### Grouping tasks

You can group tasks together by creating sub-tasks under a parent task, called a **summary task**. This allows you to divide your project into logical units, each with its own collection of tasks. The start dates, end dates and durations of summary tasks are calculated automatically from their sub-tasks.

A summary task is indicated on the Gantt chart by a solid bar extending from the beginning of the first sub-task to the end of the last one.

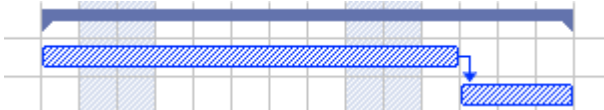

If you add sub-tasks to a task that already has a duration assigned to it, this assigned duration is automatically replaced by the new duration obtained from the sub-tasks. Once a task becomes a summary task, it is no longer possible to specify its start date, end date or duration manually. If you change the timing of a sub-task, the summary task duration is automatically adjusted to reflect the change.

The duration of a summary task is the number of available working days between its start and its end, regardless of whether work is actually happening on any given day. The figure is calculated from the available working hours between the two dates, as specified on the project calendar, and the 'Hours per day' figure set in the Project Calendars Settings dialog. For more information about calendar settings, see "[Defining calendars](#)".

Sub-tasks are sub-branches, and you create them in the Gantt view in the same way as in any other view. The parent task is converted automatically to a summary task when you add its first sub-task.

You can convert an existing task to a sub-task or move it to a different level in the task hierarchy just as in the Outline view:

- Select the task you want to move to a different location by clicking it with the left mouse button.
- While keeping the left mouse button pressed, drag the task to the required location.

The mouse pointer changes to a different shape to show you where the task will be inserted when you let go of the mouse button.

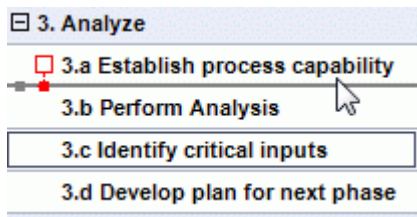

In the example below, dropping the "3.c" task at the task position shown in red by the **Move**

icon  will make it a sub-task of the task "3.a".

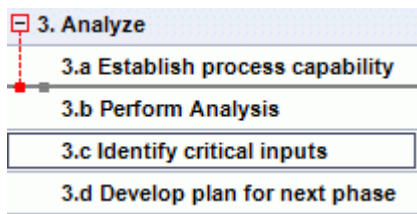

Dragging the "3.c" task to the left until the Move icon reaches the left dot will keep it at the same hierarchical level (i.e. as sub-task of "3. Analyze" task) and insert it between the "3.a" and "3.b" tasks.



- You can also click the **Indent** icon  of the Gantt Tools tab (or press the keys **Alt + Shift + right arrow**) to move the selected task or tasks to the next level down in the hierarchy, so that they become sub-tasks of the preceding task in the Gantt Outline.
- Conversely, you can click the **Outdent** icon  (or press the keys **Alt + Shift + left arrow**) to move the selected task or tasks to the next level up in the hierarchy.

The root of the mind map, the first task in the Gantt Outline, is a summary task extending across the whole of the project plan. The end of this summary task bar indicates the current end date of the project.

You can expand and collapse summary tasks just as in the main Outline view. See "[Using the Outline view](#)" for details. Collapsing summary tasks is a useful way of making large project plans easier to view.

### Specifying other task properties

The tasks of your project plan can have many other properties. You can for instance:

- Define the task as a milestone.
- Set a deadline on the task.
- Give the task a priority.
- Specify a percentage completion for the task.
- Hide the task bar in the Gantt chart.
- Make the task inactive.

All these operations are described in detail in "[Enhancing a project plan](#)".

### Assigning resources



MindView allows you to assign resources to your task lists and project plans. Resources are the people and materials needed to complete the tasks to be performed.

MindView lets you define two types of resources:

- **Work resources**

Work resources are the people who perform the work.

For each work resource, you can define their availability (i.e. how much of their working day they can devote to it), and their rate (i.e. how much they will need to be paid per unit of work).





Work resources also have their own calendar, defining their working and non-working time. By default, resource calendars are identical to the project calendar. For more information, see "[Defining resource calendars](#)" below.

- **Material resources**

Material resources are the consumable items (paper, electricity, nails, sand etc.) that you need to carry out the project.

You can also associate a unit cost to each material resource, so that you can track the overall cost of your project in human as well as in material resources.

 If you are working on a simple task list in Task Management mode (i.e. when your document type is set to "Task Management" in the Task/Timeline panel), all resources are assumed to be of type Work, and you cannot define their availability or rate.

 Adding resources to tasks when working in Task Management mode has no effect on the task duration. If however you are working in Project Management mode (typically on a Gantt project), adding resources to a task may affect its duration. For more information on this, see "[Understanding effort-driven scheduling](#)" below.

All the resources used in your project are listed in the resource list for the entire project, called the **global resources list**. Although it is usually quicker to start by setting up the global resources list, from which you can then select the resources to assign to the different tasks, you can also create resources as you need them by assigning them to tasks.

### Assigning resources to tasks

You can assign resources to a task as follows:

- Select the task.
- In the **Task/Timeline** panel, type the resource names in the **Resources** field, separating them with semi-colons.

If the global resources list for the project already contains resources, a drop-down appears so that you can select names from it.

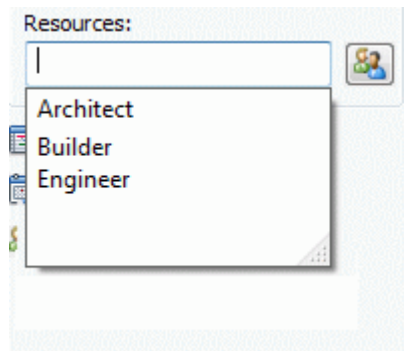

 Resources that are not already listed in the global resources list and that you create by entering them in this way are assumed to be of type **Work**, i.e. human resources. Resources of type **Material** need to be created in the global resources list, as described in "[Setting up a global resources list](#)" below.

The resources you have entered above are now assigned to the task, and added to the global resources list if they are not listed there already.

 *Where possible, it is better to select rather than type resource names. That way you don't run the risk of adding wrongly spelled entries to the global resources list.*

To de-assign a resource, simply delete it from the field. Note that this removes the resource from the task, but not from the global resources list.

You can also assign resources to a task from its **Task Information** dialog:

- Click the **Resources** button  to the right of the Resources field.

Task Information

Resources

Resources	Email address	Units	Cost
Senior management	gwillis@buildin...	100%	\$320.00
Real estate management		100%	\$0.00
IT management	sroberts@buildi...	100%	\$240.00

Remove

Project Resources... OK Cancel

- Click an empty row in the **Resources** dialog and enter the resource by typing it or by selecting it from the drop-down list.
- (optional) If you also intend to use MindView for task distribution and task tracking, enter an email address for the resource. To know more about these features, refer to "[Exporting to Microsoft Outlook](#)" and "[Managing and tracking tasks](#)". This only applies to resources of type Work (i.e. human resources).

 Once entered, email addresses can only be edited by clicking **Project Resources** at the bottom of the dialog to access the global resources list.

- (optional) The **Units** field indicates how much of the resource's available time is being used to work on the task. By default, resources are assumed to be able to devote 100% of their working time on the task. If the resource is only available part of the time, for instance because they also have other duties, specify here the percentage of their working time that they can spend on the task. You can also enter a higher value, for instance 300% if your resource is a "virtual" resource representing a group of three equivalent human resources.

 The Units value is based on the availability of the resource as shown in its resource calendar. By default, all resource calendars are identical to the project calendar. If however you have modified the calendar of the resource to indicate a different work pattern, the units value will be based on that modified resource calendar. For more about resource calendars, see "[Defining resource calendars](#)" below.

If the resource is a material resource, enter the number of units that you will need for the task.

The **Cost** field is a calculated field which shows you the cost of the resource for that task. For human resources (type Work), it is based on the unit percentage specified in Units, the cost per unit of the resource (rate), and the duration of the task. For material resources (type Material), it is based on the number of units and the cost per unit. As the field Cost is a calculated field, it cannot be edited.

Note that the Cost field is not refreshed automatically when you edit the Units field. It is only updated when you close the dialog.

To see how to specify the cost per unit of a resource, refer to "[Setting up a global resources list](#)" below.





You can customize the symbol used to represent the cost, its placement and the number of decimal digits used. For more information, see "[Setting up your preferences](#)".



The Units and Cost fields are only available when working in Project Management mode.

To de-assign a resource, select it and click **Remove**. Note that this removes the resource from the task, but not from the global resources list.

If you are working on a project plan in the Gantt view, you can also enter resources in other ways:

- Select the task and choose **Tasks | Assign Resources**  on the Gantt Tools tab.
- Select the task and choose **View | Task Information**  on the Gantt Tools tab. Click the **Resources** tab in the Task Information dialog that opens.



*You can also open the Task Information dialog by pressing **Shift + F2** or by double-clicking the task bar on the Gantt chart.*

- Click the **Resources** cell of the task at the far right of the Gantt Outline. Type the resource name(s), separating them with semi-colons.



*Once associated to a task, you can view the details of a particular resource simply by double-clicking its name in the **Resources** field of the **Task/Timeline** panel.*

### Setting up a global resources list

Although MindView lets you define the resources as you need them as we have just seen, it is usually more efficient to start by setting up a global resources list from which you can then select resources to assign to the various tasks.

The global resources list associated with a task list or project plan is saved whenever you save the file. Each task list or project plan has its own global resources list.

You can access the global list of available resources in different ways:

- Click the **Project Resources** link at the bottom of the **Task/Timeline** panel.
- Open the **Task Information** dialog of a task, click its **Resources** tab and click the **Project Resources** button in its bottom left corner.
- If you are working on a project plan in the Gantt view, choose **Project | Project Resources** on the Gantt Tools tab.

The **Project Resources** dialog lists all the resources that are currently assigned to tasks, as well as any that you import or type in directly.

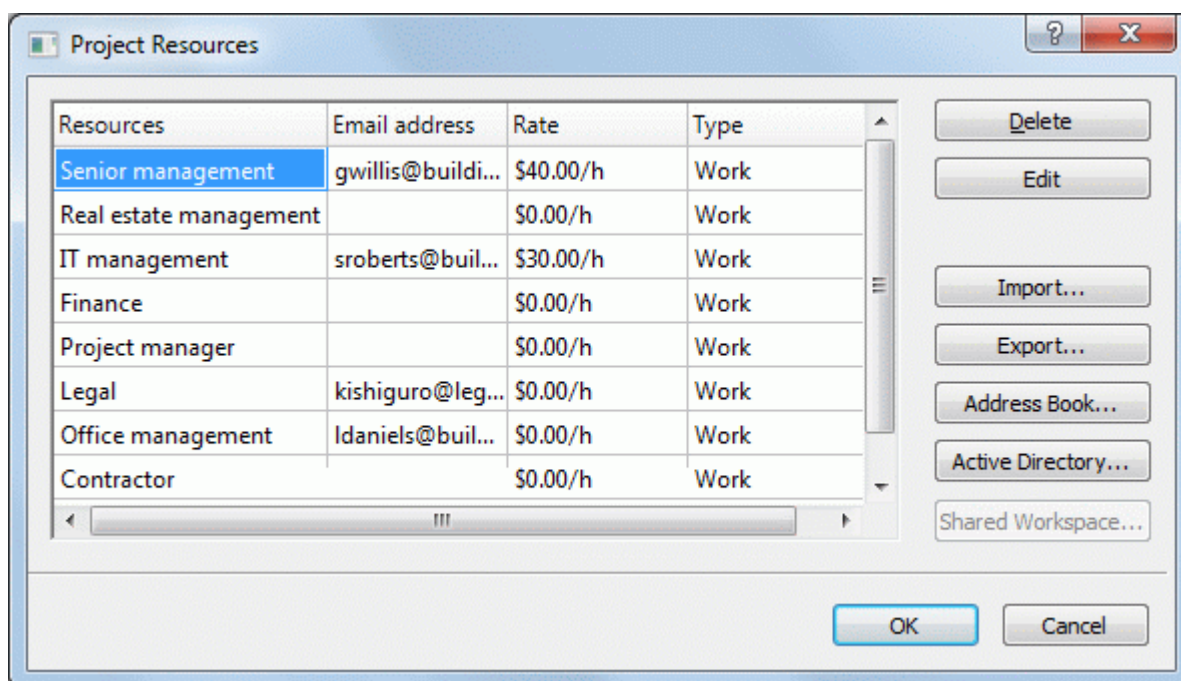

- To add a new resource to the list, click the first empty field and enter the resource name. If you also intend to use MindView for task distribution and task tracking, enter an email address for the resource. To know more about these features, refer to "[Exporting to Microsoft Outlook](#)" and "[Managing and Tracking Tasks](#)". This only applies to resources of type Work (i.e. human resources).
- (optional) If you want to be able to track the overall cost of your project, you can specify the cost per unit of the resource in the **Rate** field. Although the default time unit is **h** (per hour), you can enter other time units: **m** (per minute), **d** (per day), **w** (per week), **mo** (per month), **y** (per year). To specify a rate of \$320 per day for instance, you would enter 320/d.

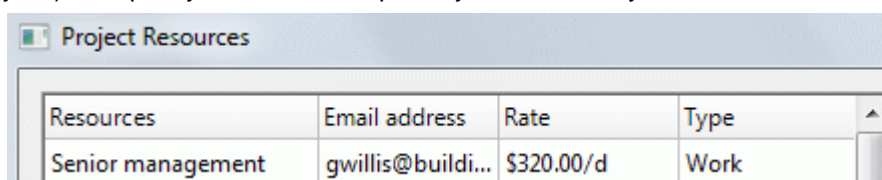

- 🔗 You can customize the symbol used to represent the rate, its placement and the number of decimal digits used. For more information, see "[Setting up your preferences](#)".
- (optional) By default, all resources are assumed to be of type Work, i.e. human resources. The column **Type** lets you change the type of a resource from Work to Material. The rate of a material resource is its cost per unit. If you want to indicate a unit of measurement for a material resource (e.g. tons, cubic meters, boxes, etc.) you can do so by clicking the **Edit** button and entering this information in the **Material label** field of the dialog box that appears.
- 🔗 The Rate and Type fields are only available when working in Project Management mode.

The **Project Resources** dialog lets you perform other operations:

- To delete one or more resources, select them and click **Delete**.
- 💡 Use the **Shift** key to select contiguous resources and the **Ctrl** key to select non-contiguous resources.
- To import a previously exported global resources list, click **Import** and select the required list.





You can also import the resources list of an existing Microsoft Project document by exporting that document to XML from Microsoft Project, then choosing the exported XML document in this dialog.

- To export the global resources list for use in other documents or for sharing with colleagues, click **Export**, and choose a folder and file name for your exported list.
-  When exported, the global resources list is saved in the MindView XML format.
- To import one or more resources from your Microsoft Outlook Address Book, click **Address Book**, select the contact names you want to add as resources in the Outlook dialog, click the Add button and click OK.
- To import one or more resources from the Windows Active Directory database, click **Active Directory**. In the dialog box that opens, click the Advanced button, then the Find Now button. Select the user(s) you want to add as resources in the bottom part of the dialog, and click OK. The Active Directory is a centralized database maintained by Windows to store information relating to an organization's network (such as resources, services and users).
- If you are working on an online document hosted on the MatchWare Shared Workspace, clicking **Shared Workspace** will allow you to select resources from the list of registered users of the workspace. For more information about the MatchWare Shared Workspace, see "[Setting up an online workspace](#)".

### Defining resource calendars

As soon as you create a new resource, MindView creates a resource calendar for it, defining the working and non-working time of the resource. By default, resource calendars are identical to the project calendar. If all your resources follow the work pattern defined by the project calendar, you do not need to edit any of their calendars. If on the other hand some of your resources only work part-time for instance, you can indicate this in their calendars, so that MindView can take this into account when scheduling tasks to which they have been allocated.

Any changes you make to the project calendar are automatically transferred to all the resource calendars. However, specific changes you might have made to the working time of a particular resource are preserved.

For more information about how to edit a resource calendar, see "[Defining calendars](#)".

### Understanding effort-driven scheduling

Before you assign any resources to a task in a Gantt project, the task has no work associated with it. It is the process of assigning resources to a task that define its work value, which is the amount of effort the resource or resources will need to spend on the task to complete it.

For each resource, work is defined according to the scheduling formula : **Work = Duration x Units**.

The overall work value for the task is the sum of the work performed by each resource.

Therefore if you have just one resource working 100% of their time on the task, the work value for the task will be the same as the duration, as the example below shows.

Task Name	Duration	Start	End	Resources	Work
Subject	1 day	04.06.14	04.06.14		8 hrs
Task1	1 day	04.06.14	04.06.14	John	8 hrs

In general, the work value will differ from the duration only if you assign more than one resource to the task, or if the resource does not work full-time on the task.

The example below shows the effect of adding another resource, Bill, also working 100% of their time, on Task1. As Bill is also going to produce 8 hours of work, the overall work value for the task goes from 8 hours to 16 hours, but the duration is still only 1 day.

Task Name	Duration	Start	End	Resources	Work
Subject	1 day	04.06.14	04.06.14		16 hrs
Task1	1 day	04.06.14	04.06.14	John;Bill	16 hrs





You may however want to produce a different result and expect that by adding another full-time resource to the task, the amount of work needed to perform the task should remain constant, and it should therefore be completed in half the time. This scheduling method is known as **effort-driven scheduling**. By default, MindView does not apply effort-driven scheduling, but you can choose to activate this scheduling method on your tasks. With effort-driven scheduling activated, adding Bill to Task 1 in our 1st example would produce the result below:

Task Name	Duration	Start	End	Resources	Work
Subject	0.5 day	04.06.14	04.06.14		8 hrs
Task1	0.5 day	04.06.14	04.06.14	John;Bill	8 hrs

You can see that the amount of work has now remained constant at 8 hours, but the duration has decreased to half a day.

- To activate effort-driven scheduling for a task, open its **Task Information dialog** on its **General** tab and check the **Effort-driven** option.

 Effort-driven scheduling only affects the scheduling of a task when you assign or remove resources from it, and is independent from the scheduling type of the task. For more information about task types, see "[Using scheduling task types](#)".

 If you want MindView to apply effort-driven scheduling to all the tasks of the projects you create, you can specify this in the **MindView Options**. For more information, see "[Setting up your preferences](#)". You can also choose to activate effort-driven scheduling only for the new tasks of the open document. To do this, click the **File** tab, choose **Prepare | Properties** and set the **New tasks are effort-driven** option to Yes.

## Using scheduling task types

As we have seen in "[Assigning resources](#)", it is the process of assigning resources to a task in a Gantt project that define its work value, which is the amount of effort the resource or resources will need to spend on the task to complete it.

For each resource, work is defined according to the scheduling formula **Work = Duration x Units**, where Duration is the duration of the task and Units is the percentage of availability of the resource for the task.

The overall work value for the task is the sum of the work performed by each resource.

## Understanding task types

### Fixed Units tasks

By default, all the tasks you create in a Gantt project with MindView are given the task type **Fixed Units**. This means that the percentage of availability of each resource (units) you defined when you assigned the resources to the task always remains the same, regardless of any changes you might make to the Duration or Work values.

- If for instance you increase the task's duration, the work value will be recalculated and increased accordingly.
- If you increase the task's work value, the duration is recalculated and increased accordingly.

In either case, the percentage of availability of the resources (units) remains unchanged.

Let us consider for instance a task of one day (**Duration** = 1 day), allocated to John and Bill, each working at 100% of their availability (**Units** = 100%).

The **Work** value of the task is therefore 16 hours (8 hours for John + 8 hours for Bill).

Task Name	Duration	Start	End	Resources	Work
Subject	1 day	04.06.14	04.06.14		16 hrs
Task1	1 day	04.06.14	04.06.14	John;Bill	16 hrs

- In the first example, we increase the duration from 1 day to 2 days. In consequence, the work value is increased automatically to 32 hours.

Task Name	Duration	Start	End	Resources	Work
Subject	2 days	04.06.14	05.06.14		32 hrs
Task1	2 days	04.06.14	05.06.14	John;Bill	32 hrs

- In the second example, we decrease the work value from 16 hours to 8 hours. In consequence, the duration is decreased automatically to half a day.

Task Name	Duration	Start	End	Resources	Work
Subject	0.5 day	04.06.14	04.06.14		8 hrs
Task1	0.5 day	04.06.14	04.06.14	John;Bill	8 hrs

In both cases, the units value for John and Bill has remained unchanged at 100%.

This default behavior may however not be what you would want to happen. For this reason, MindView supports two other task types, **Fixed Duration** and **Fixed Work**.



The fact that a task has the type Fixed Units does not mean that you cannot change the percentage of availability of its resources (units). It only defines what happens when you modify the other two values in the scheduling formula, i.e. Duration and Work.

**Fixed Work tasks**

In a **Fixed Work** task, when you change the task's Units or Duration value, MindView recalculates the other value accordingly.

- If for instance you increase the percentage of availability of the resource (units), the duration will be recalculated and decreased accordingly.
- If you increase the task's duration, the percentage of availability of the resource (units) is recalculated and decreased accordingly.



You can still change the Work value of Fixed Work tasks. This task type only defines what happens when you modify the other two values in the scheduling formula, i.e. Duration and Units.

Let us consider again a task of one day (**Duration** = 1 day), allocated to John and Bill, each working at 100% of their availability (**Units** = 100%).

The **Work** value of the task is 16 hours (8 hours for John + 8 hours for Bill).

Task Name	Duration	Start	End	Resources	Work
Subject	1 day	04.06.14	04.06.14		16 hrs
Task1	1 day	04.06.14	04.06.14	John;Bill	16 hrs

- In the first example, we decrease the percentage of availability (units) of both John and Bill to 50%. As the work value must remain fixed, the duration is increased automatically to 2 days.

Task Name	Duration	Start	End	Resources	Work
Subject	2 days	04.06.14	05.06.14		16 hrs
Task1	2 days	04.06.14	05.06.14	John[50%];Bill[50%]	16 hrs

- In the second example, we decrease the task duration from 1 day to 0.5 days. As the work value must remain fixed, the percentage of availability (units) of both John and Bill is increased automatically to 200%.

Task Name	Duration	Start	End	Resources	Work
Subject	0.5 day	04.06.14	04.06.14		16 hrs
Task1	0.5 day	04.06.14	04.06.14	John[200%];Bill[200%]	16 hrs

In both cases, the work value has remained fixed at 16 hours.

### Fixed Duration tasks

In a **Fixed Duration** task, when you change the task's Units or Work value, MindView recalculates the other value accordingly.

- If for instance you increase the percentage of availability of the resource (units), the work value will be recalculated and increased accordingly.
- If you increase the task's work value, the percentage of availability of the resource (units) is recalculated and increased accordingly.



You can still change the Duration value of Fixed Duration tasks. This task type only defines what happens when you modify the other two values in the scheduling formula, i.e. Units and Work.

Let us consider again a task of one day (**Duration** = 1 day), allocated to John and Bill, each working at 100% of their availability (**Units** = 100%).

The **Work** value of the task is 16 hours (8 hours for John + 8 hours for Bill).

Task Name	Duration	Start	End	Resources	Work
Subject	1 day	04.06.14	04.06.14		16 hrs
Task1	1 day	04.06.14	04.06.14	John;Bill	16 hrs

- In the first example, we decrease the percentage of availability (units) of both John and Bill to 50%. As the duration value must remain fixed, the work value is decreased automatically to 8 hours.

Task Name	Duration	Start	End	Resources	Work
Subject	1 day	04.06.14	04.06.14		8 hrs
Task1	1 day	04.06.14	04.06.14	John[50%];Bill[50%]	8 hrs

- In the second example, we increase the work value from 16 hours to 32 hours. As the duration value must remain fixed, the percentage of availability (units) of both John and Bill is increased automatically to 200%.

Task Name	Duration	Start	End	Resources	Work
Subject	1 day	04.06.14	04.06.14		32 hrs
Task1	1 day	04.06.14	04.06.14	John[200%];Bill[200%]	32 hrs

In both cases, the duration has remained fixed at 1 day.

### Summary

The effect of changing units, work and duration on a task of different types can be summarized by the table below:

TASK TYPE	If you increase Units	If you increase Work	If you increase Duration
Fixed Units	Duration decreases	Duration increases	Work increases
Fixed Work	Duration decreases	Duration increases	Units decrease
Fixed Duration	Work increases	Units increase	Work increases

### Changing the task type

- To change the scheduling type of a task, select the task and choose **View | Task Information**  on the Gantt Tools tab.

 You can also open the Task Information dialog by pressing **Shift + F2** or by double-clicking the task bar on the Gantt chart.

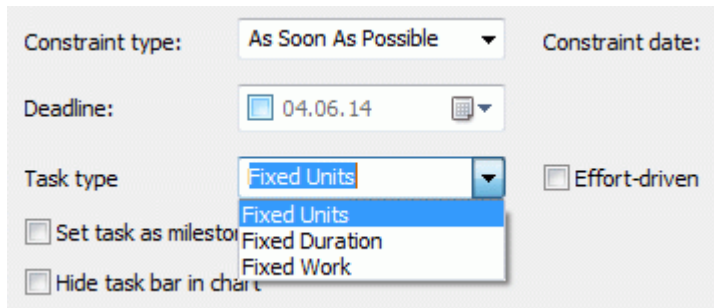

 Setting a task type to Fixed Work automatically sets the Effort-driven option. Fixed Work tasks cannot have effort-driven scheduling turned off as their work value must remain fixed. For more information about effort-driven scheduling, see "[Understanding effort-driven scheduling](#)" in the topic "[Assigning resources](#)".

 If you want MindView to apply the same task type to all the tasks of the documents you create, you can specify this in the **MindView Options**. For more information, see "[Setting up your preferences](#)". You can also choose to apply a particular task type only for the new tasks of the open document. To do this, click the **File** tab, choose **Prepare | Properties** and set the **Default task type** option to your chosen task type.

## Using links

 Project plans normally require tasks to be performed in a specific order. For instance, a publication must be written and proofread before it can be printed. To achieve this, MindView lets you link tasks so that they depend on each other. By default, tasks are linked in a 'Finish to Start' relationship (dependency), which means that the first task you select (the **predecessor** task) must end before the next task you select (the **successor** task) can start, and so on.

This is represented on the Gantt chart by lines with arrowheads joining each task to its successor. The arrowhead indicates the direction of the link: it goes from the predecessor to the successor.

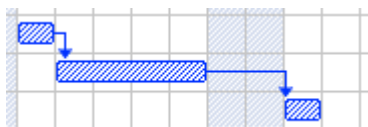

A task can have more than one predecessor. In this case its start date is determined by the predecessor link that gives it the latest start date. As dates and times change during the course of the project, the predecessor link that determines the start date of the task may also change.

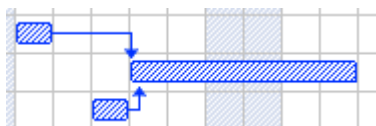

Similarly a task can have several successors. In this case the task determines the start date of all its successor tasks.

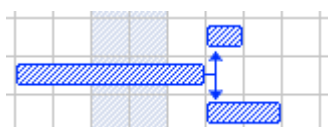

When you are scheduling a project plan from its start date (see "[Defining the global project settings](#)"), MindView calculates the end date of the project automatically, on the basis of the task durations, the task dependencies and the project calendar.

The possibility of linking tasks in this way is what makes project management software particularly powerful: you can change the duration of one or more tasks, add a task or remove a task from a chain of linked tasks, and all the dates are recalculated automatically so as to maintain the task dependencies you have defined.

## Linking tasks

You can link tasks in the following ways:

- Select the tasks to be linked, in the order you want them to be linked, by Shift-clicking them (for contiguous tasks) or Ctrl-clicking them (for non-contiguous tasks), then click the **Link** icon  on the Gantt Tools tab.



*You can also just press **Ctrl + F2**.*

- Place the pointer on the bar of the predecessor task. When it changes to an icon with four arrows, drag the pointer downwards (or upwards) until a line emerges from the task bar and a link icon appears under the pointer. Continue dragging until the line reaches the bar of the successor task and release the mouse button.

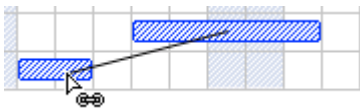

- Select the task to be linked to. Click its **Predecessors** cell in the Gantt Outline and type the entry number(s) of the predecessor task(s). Separate multiple numbers by semi-colons.
- Select the task to be linked to and choose **Task Information**  on the Gantt Tools tab to open its Task Information dialog. Click the Predecessors tab and select the predecessor task(s).



*You can also open the Task Information dialog by pressing **Shift + F2** or by double-clicking the task bar on the Gantt chart.*



All these methods create the default task relationship, namely 'Finish to Start'. See below to find out how to create other types of relationships.

In the example below, the proofreading task (successor) has been linked to the writing task (predecessor). The proofreading task cannot start before the writing ends. If the writing task is delayed or takes longer than planned, the start date of the proofreading task is recalculated automatically so that the task relationship is always maintained.



You can link summary tasks in the same way as other tasks, but not to one of their own sub-tasks. Linking a summary task to another summary task has the same effect as linking its last sub-task to all of the sub-tasks in the other summary task. To make your project plan easy to read, it is usually best to link summary tasks only to summary tasks and sub-tasks to sub-tasks (within the same summary task), like this:

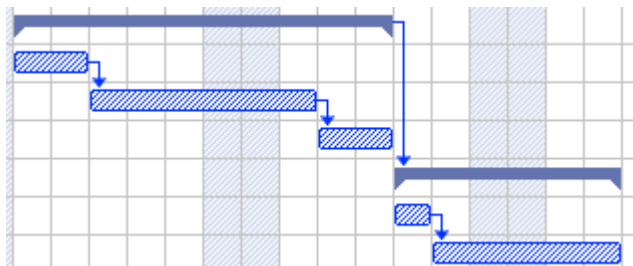

Alternatively you may prefer to restrict linking to regular tasks. Links from summary tasks to regular tasks tend to confuse the display.





A summary task can only be linked to its predecessors with a 'Finish to Start' or 'Start to Start' relationship.



## Unlinking tasks

You can unlink tasks in the following ways:

- Select the tasks by Shift- or Ctrl-clicking them, then click the **Unlink** icon  on the Gantt Tools tab.
- 💡 *You can also just press **Ctrl + Shift + F2**.*
- On the Gantt chart, right-click the link you want to remove and choose **Edit Link** in its local menu. This opens the Task Information dialog. Select the predecessor task you want to remove and click Delete.
- Select the task whose predecessors you want to remove. Click its **Predecessors** cell in the Gantt Outline and delete the number(s) of the predecessor(s) you want to remove.
- Select the task whose predecessors you want to remove and choose **Task Information**  on the Gantt Tools tab to open its Task Information dialog. Click the Predecessors tab, select each predecessor task you want to remove and click Delete.

## Defining lead or lag time

By adding a **lead** or **lag** time you can extend a link backwards or forwards so that the successor task starts earlier or later than it otherwise would. For a default 'Finish to Start' link, this either introduces an overlap (lead time), so that the successor task starts before its predecessor ends, or it introduces a delay (lag time) that makes the successor task start some time after its predecessor ends.

When planning the production of a marketing brochure for instance, you could use lead time to make the creation of artwork start a few days before the writing phase is over. The two tasks are however still linked, which means that a delay of the writing phase will also delay the creation of the artwork.

- Select the successor task and choose **Task Information**  to open its Task Information dialog.
- Click the **Predecessors** tab.
- In the **Lag** column for the task, enter the appropriate lead or lag time. A positive value indicates a lag time (a delay); a negative value indicates a lead time (an overlap). You can follow the number with letter(s), for example w for weeks, as described in the paragraph "[Entering a task duration](#)" in "[Entering and editing tasks](#)".

You can also enter percentage values, for example if you enter "-25%" the task will start 75% of the way through the predecessor task. Note that percentages relate to the duration of the predecessor task.

In the following example, we start with three linked tasks (to save space, the Start and End columns are not shown):

Task Name	Duration	Predecessors
1 Painting work	10 days	
2 Prepare surface	4 days	
3 Undercoat	3 days	2
4 Top coat	3 days	3

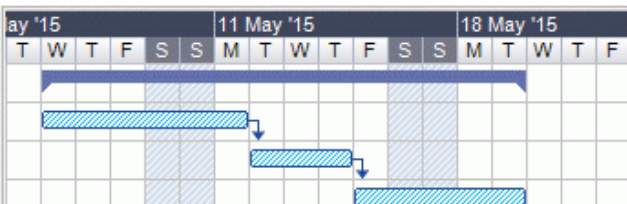

Notice that the Predecessors column shows the number of each task's predecessor. Experience shows that we can actually start applying undercoat when surface preparation is three quarters complete, in other words when only 25% remains to be done. To give the desired overlap (lead time) we enter a lag of -25%, as described above:

Task Name	Duration	Predecessors
1 Painting work	9 days	
2 Prepare surface	4 days	
3 Undercoat	3 days	2FS-25 %
4 Top coat	3 days	3

Because surface preparation has currently been allocated 4 working days, the undercoat task starts after the third working day. As usual, no work is scheduled during non-working days. Notice that the **Predecessors** column now includes the type of link (FS, or 'Finish to Start'), and the amount of lead time (-25%).

Now we want to allow a 1-day gap after the undercoat task to ensure that the undercoat is fully dry before the top coat is applied. To give the desired delay we enter a lag of 1 day, as described above:

Task Name	Duration	Predecessors
1 Painting work	10 days	
2 Prepare surface	4 days	
3 Undercoat	3 days	2FS-25 %
4 Top coat	3 days	3FS+1 day

If we now have to change the duration of the surface preparation task to 8 days, everything moves out. However, the 25% overlap (which now represents 2 working days) and the 1-day delay are preserved:

Task Name	Duration	Predecessors
1 Painting work	13 days	
2 Prepare surface	8 days	
3 Undercoat	3 days	2FS-25 %
4 Top coat	3 days	3FS+1 day

Although the example above shows tasks linked by the default 'Finish to Start' relationship, you can apply lead or lag time to any type of task relationship.

 Moving linked bars by dragging does not set lead or lag times, but instead sets constraints which override the linking. See "[Using constraints](#)" for more information.

## Using other task relationships

MindView supports four different relationships (dependencies) between tasks:

- **Finish to Start (FS) - the default:** The task cannot start before its predecessor ends, although it may start later. This is the most common type of relationship and the only link you can create by clicking the Link icon , as described above. Typically the successor starts as soon as the predecessor is complete. You can introduce an overlap or delay by using lead and lag times, but still, if the end date of the predecessor task moves, so will the start date of the successor.
- **Start to Start (SS):** The task cannot start until the predecessor starts, although it may start later. This can be useful if you have a task whose start date depends on the start date of another task.
- **Finish to Finish (FF):** The task cannot end before the predecessor ends, although it may end later.
- **Start to Finish (SF):** The task cannot end before the predecessor starts, although it may end later. This task relationship is rarely used.

To change the relationship between two tasks:

- Select the successor task and choose **Task Information**  to open its Task Information dialog.





You can also just double-click the link between the predecessor and the successor task on the Gantt chart.

- Select the predecessor on the **Predecessors** tab.
- In the **Type** column, select the new relationship type.

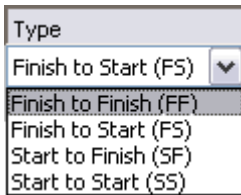

**Example**

The following project plan for the preparation of a publication illustrates all these kinds of relationships.

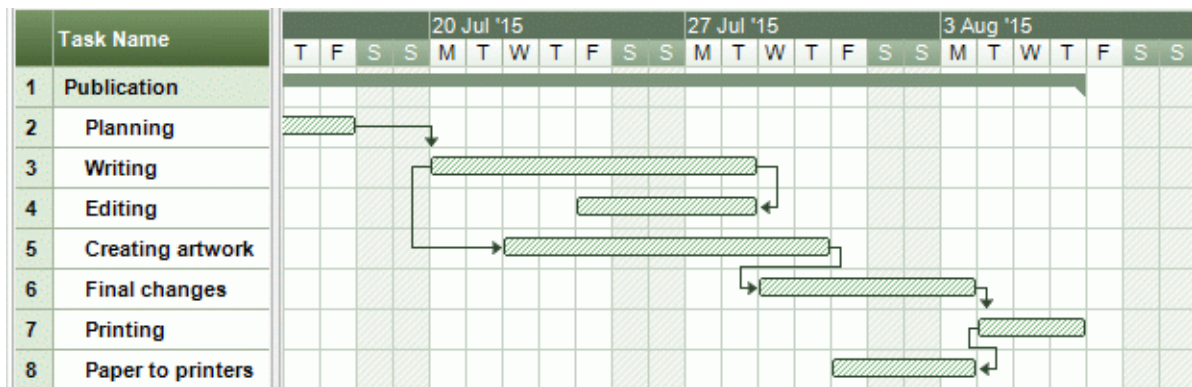

In this example:

- The writing task follows on directly from the planning task. If the end date of planning changes, so will the start of writing. This is the normal **Finish to Start** relationship.
- The editing task starts some way through the writing task. The writers and the editors work together as a team until the text is complete. Their tasks effectively end at the same time. If the end date of writing changes, so will the end date of editing. This is a **Finish to Finish** relationship.
- The creation of artwork depends on the start of writing. In this case a lag has been introduced so that it doesn't start exactly when writing starts. Even so, if the start of writing changes, so will the start of artwork creation. This is a **Start to Start** relationship.
- The final changes task depends on the end of artwork creation, but an overlap is included so that it actually begins two working days before the end date of artwork creation. If artwork creation is delayed, so will be the start of final changes. This is the normal **Finish to Start** relationship.
- Printing starts after final changes are complete. This is also a **Finish to Start** relationship.
- The transferring of paper from the warehouse to the printers must be complete in order for printing to start, but is not related to any of the preceding tasks. The printers have limited storage capacity and do not want the paper to arrive until it is needed, so the start of printing drives the delivery of paper. If the start of printing changes for some reason, so will the end date for getting paper to the printers. This is a **Start to Finish** relationship.

Here each task has a single predecessor, the simplest arrangement. However, a task *can* have several predecessors. In such situations you will need to think carefully about possible undesirable consequences. For example, if you added another predecessor to the "Paper to printers" task above, it would be possible for that predecessor to push out "Paper to printers" so that its end date was later than the start of printing.

## Using constraints

Constraints define the degree of flexibility available to MindView when scheduling or rescheduling a task by imposing restrictions on its start or end date.









MindView supports 8 types of task constraints, offering different degrees of flexibility.



### Constraint types

Two "constraints" are actually so flexible that they are not generally regarded as constraints at all:

- **As Soon As Possible (ASAP):** This is the default constraint when you schedule your project from its start date, as is normally the case (see "[Defining the global project settings](#)"). You should try to keep this default whenever possible as it gives MindView the most scheduling flexibility. If you apply this constraint to an unlinked task, the task will be scheduled to start at the project start date. If you apply it to a linked task, it will start as soon as the dependencies with its predecessor tasks will allow.
- **As Late As Possible (ALAP):** This is the default constraint when you schedule your project from its end date. If you apply this constraint to an unlinked task, the task will be scheduled so that its end date coincides with the end date of the overall project. If you apply it to a task linked to a successor task, the task will be scheduled to end when the successor needs to start. On the whole, you should avoid this constraint as it does not leave any slack time to deal with possible problems. Any delay on the task is likely to impact the overall end date.

The following constraints all restrict MindView's flexibility when scheduling tasks. Although you might be tempted to use them if you are new to project management, you need to make sure you understand the implications. Keeping their use to a minimum (especially the last two) will allow you to take full advantage of MindView's automatic scheduling possibilities.

- **Start No Earlier Than (SNET)** : This means that the task, whether linked or not, may not start before the given date. However, MindView still has the flexibility to start the task later than the given date.
  -  *If you change a task's start date, for instance by typing a new date in the Gantt Outline or by moving its task bar on the Gantt chart, this constraint is automatically applied.*
  -  *If you drag a linked task backwards, a SNET constraint is set for the start date corresponding to the new position of the task bar, but the bar immediately moves back to its original position. This is because the start date determined by the link comes later than the SNET date. The SNET date is therefore applied, but does not change the original scheduling of the task.*
- **Start No Later Than (SNLT)** : This means that the task, whether linked or not, may not start later than the given date. However, MindView still has the flexibility to start the task earlier than the given date.
  -  *When you are scheduling your project from its end date, changing a task's start date automatically applies this constraint.*
- **Finish No Earlier Than (FNET)** : This means that the task, whether linked or not, may not end before the given date. However, MindView still has the flexibility to end the task later than the given date.
  -  *If you change a task's end date, this constraint is automatically applied.*
- **Finish No Later Than (FNLTL)** : This means that the task, whether linked or not, may not end later than the given date. However, MindView still has the flexibility to end the task earlier than the given date.
  -  *When you are scheduling your project from its end date, changing a task's end date or moving its task bar on the Gantt chart automatically applies this constraint.*

- **Must Start On (MSO)**  : This rigid constraint means that the task, whether linked or not, must start on the given date. Even if the preceding task is completed earlier, MindView cannot pull in the constrained task to take advantage of the time gained.
- **Must Finish On (MFO)**  : This rigid constraint means that the task, whether linked or not, must end on the given date. As above, even if the preceding task is completed earlier, MindView cannot pull in the constrained task to take advantage of the time gained.

When you apply one of these constraints to a task, a constraint icon appears next to its name in the Gantt Outline. Hovering this icon with the mouse displays a tooltip with details about the constraint.

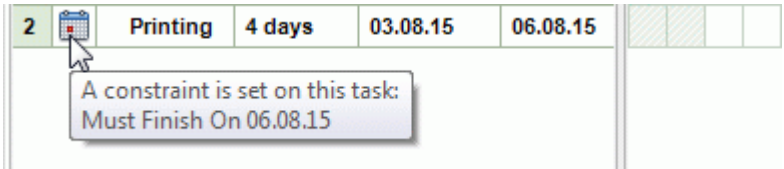

 *If you decide to apply one of these constraints to a task, it is good practice to attach a note or a comment to the task to explain why you did so. If the constraint causes scheduling conflicts later on as your project evolves, you will be able to refer to the note to decide whether to keep the constraint, change it or remove it altogether. Such notes also allow you to distinguish easily between the tasks you have constrained yourself deliberately and the tasks you may have constrained inadvertently by moving their task bar or editing their start or end date manually.*

You can sometimes avoid using constraints by setting deadlines instead (see "[Setting deadlines](#)" in the topic "[Enhancing a project plan](#)"). If you have an important date to meet, it is usually better to set a deadline on the task rather than a constraint such as 'Must Finish On'. Not only this type of constraint restricts MindView's scheduling flexibility, but it may in fact increase the likelihood of missing the deadline, as the example below shows.

 *The effect of a constraint is not always obvious when you schedule your project plan from its end date, so take care to check that it does give the result you want.*

**Example**

The following example shows some tasks in the preparation of a brochure for a mail shot. The mail shot is scheduled for September 14th. The tasks are linked, but we have set a 'Must Finish On' constraint on the printing task for September 11th, the latest date that will allow the mailing to go ahead on the following Monday, September 14th. The constraint, as usual, overrides the link. By setting a 'Must Finish On' constraint for September 11th, we have effectively moved the task out so that it ends exactly on September 11th, regardless of whether it could have been completed earlier or not.

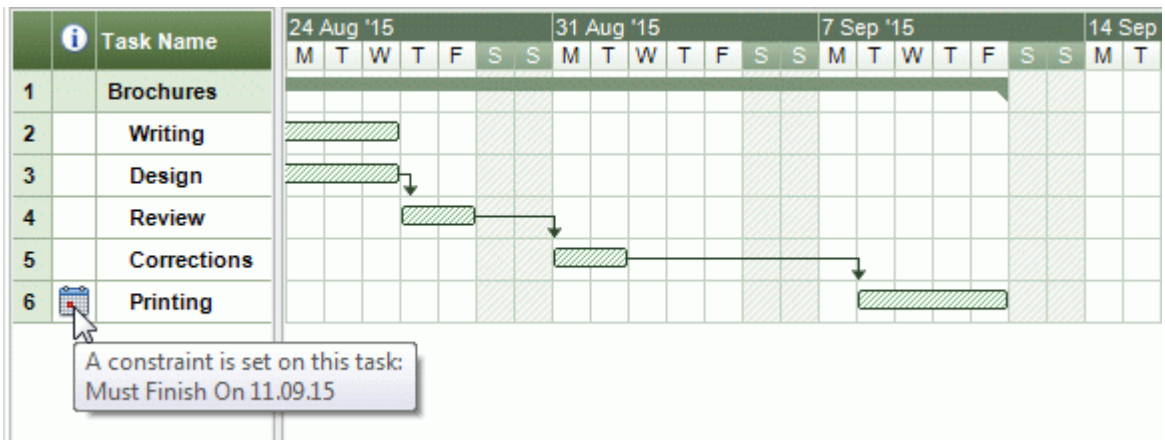

The problem with this is that if the printing task takes longer than expected, the mailing date will be missed. It would be much better to take advantage of the unused time after the end of the corrections task to get started with printing. However, we still need to keep an eye on the

September 11th deadline. To do this, we remove the constraint from the printing task, so that the link will determine its start date, and add a deadline marker instead.

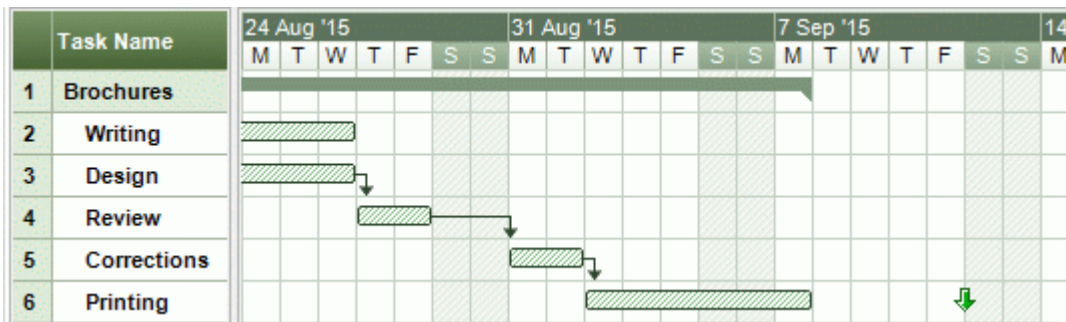

Now there is a useful gap between the end of printing and the deadline, and the deadline is clearly indicated. The printing task is now much less likely to appear on the critical path, and the deadline indicator will warn us if the task moves past its deadline.

### Interaction between task dependency links and constraints

Constraints combine with task dependency links to affect the timing of tasks. In some cases, applying a constraint to a task in addition to a task relationship may create a scheduling conflict. When such a conflict arises, the constraint always takes precedence over the task dependency.

Let us consider the example below. Here the "Print" task is linked to the "Final changes" task with the default 'Finish to Start' relationship. The "Final changes" task ends on Oct 1st. In normal circumstances, this would mean that the "Print" task cannot start before Oct 2nd. However, because you imperatively need the printed materials on Sept 28th for a training session, you have set a 'Must Finish On' constraint on the "Print" task for Sept 28th, as evidenced by the constraint indicator. Since the constraint set on a task always overrides any relationship it may have with other tasks, the start date of the "Print" task has been rescheduled automatically to end on Sept 28th.

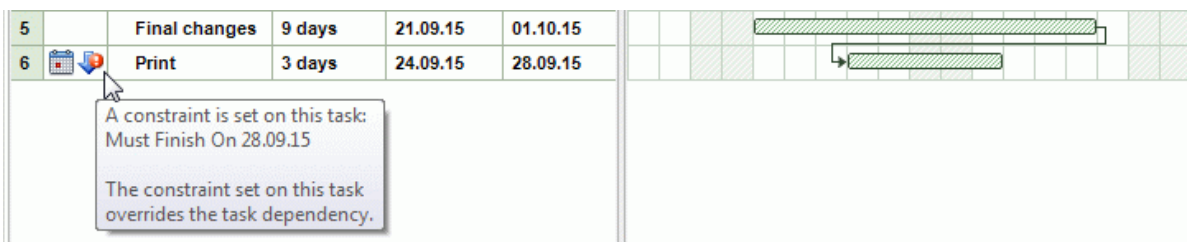

In this case the constraint has led to an illogical relationship with the predecessor task: printing is now scheduled to start before final changes are complete. Note that MindView conveniently flags this as a possible problem using the icon, which shows that a link has been overridden by a constraint.

If you later decide to remove the constraint, for instance because the training session has been postponed, the task dependency link is enforced again, as shown here:

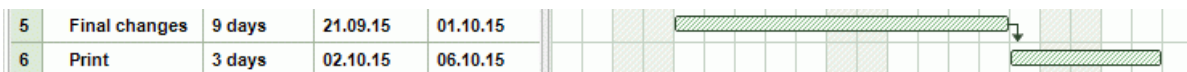

For more information about how to detect and solve potential scheduling conflicts, see "[Reviewing a project plan](#)".

### Setting a constraint

You can apply a constraint to a task as follows:

- Select the task and choose **Task Information** to open its Task Information dialog.
- Select the constraint type. For constraints other than 'As Soon as Possible' or 'As Late As Possible', you also need to set the constraint date required.

Constraint type:  Constraint date:  02.09.15

As mentioned above, changing a task's start date by editing it in the Gantt Outline or moving its task bar on the Gantt chart applies a 'Start No Earlier Than' constraint automatically (assuming you are scheduling from the project start date). Changing a task's end date applies a 'Finish No Earlier Than' constraint.

When scheduling from the end, changing a task's start date applies a 'Start No Later Than' constraint. Changing a task's end date applies a 'Finish No Later Than' constraint.

- To remove a rigid constraint, select 'As Soon as Possible' in the **Task Information** dialog (or 'As Late As Possible' if you are scheduling from the end).

## Enhancing a project plan

There are various things you can do to make your project plan easier to use. For example:

- You can add explanatory notes to tasks. This is especially useful for tasks that have constraints. Constraints override links and can lead to illogicalities or schedule conflicts in the plan, so you will need to keep an eye on them.
- You can highlight the critical path in order to see at a glance the tasks that are currently directly affecting your project end date.
- You can set milestones or deadlines to mark key dates.
- You can give tasks priorities.
- You can show a percentage completion for any task, visible on the task bar.
- You can prevent some tasks from appearing on the Gantt chart by hiding their task bar.
- You can make some tasks inactive, so that they no longer affects the scheduling of the project.
- You can customize the display of the project plan on the Gantt chart.

All these operations are described in detail below.

### Adding notes

You can add notes and comments to any task, just as in all the other MindView views. See "[Inserting text notes](#)" and "[Inserting comments](#)".

### Viewing the critical path

In a project plan, the critical path corresponds to the tasks or chain of linked tasks that cannot be delayed without delaying the entire project. A task lies on the critical path if a change to its start date or duration affects the end date of the project (or the start date if you are scheduling from the end of the project).

Keeping a close eye on the status of your critical tasks at any time is therefore key to good project management. If the overall project duration is too long, the only way to make it shorter and bring in its end date is to shorten the critical path.

- To toggle the critical path on or off, click **Show Critical Path**  on the Gantt Tools tab. Tasks on the critical path are highlighted in red.



*You can change the color used to highlight the critical tasks from the Properties dialog. See "[View properties: General tab](#)" for more information.*

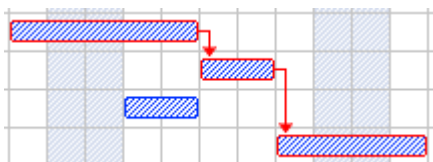

### Setting milestones

A milestone is a task with zero duration. It appears on the Gantt chart as a solid diamond. Milestones are generally used to indicate important dates on the project plan, often key events or goals. For example, you might use milestones to mark desired completion dates, or project review meetings.



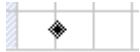

As with any task, a milestone can be linked to other tasks. However, milestones are generally used as fixed markers and are therefore not normally linked.

To enter a milestone:

- Create a task and give it a duration of 0.

To convert a task to a milestone:

- Select the task and give it a duration of zero, or
- Select the task and choose **Task Information**  on the Gantt Tools tab to open its Task Information dialog. Check the option **Set task as milestone**.

To convert a milestone to a task:

- Select the milestone and give it a non-zero duration.

## Setting deadlines

You can add a deadline marker to any task. This does not affect any of MindView's Gantt calculations, but places a visible marker on the Gantt chart as a reminder.



If the task end date moves past the deadline, a missed deadline icon appears in the Indicators column of the Gantt Outline.

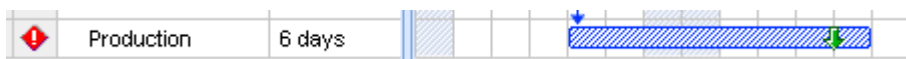

To add a deadline to a task:

- Select the task and choose **Task Information**  to open its Task Information dialog. In the **Deadline** field, select the deadline date.

To remove a deadline from a task, you open the Task Information dialog again and remove the check mark from the Deadline field.

## Assigning priorities

You can assign a priority to a task in the following ways:

- Select the task and choose **Task Information**  to open its Task Information dialog. Enter a priority number in the **Priority** field.
- Select the task. On the **Task/Timeline** panel, enter a priority number in the **Priority** field.



Although priorities can range from 0 to 1000, you can use any convenient scale, for example 1 (highest priority) to 10 (lowest priority).

## Setting completion values

You can indicate the progress that has been made towards completing a task by entering a % completion value. A thick line on the task bar indicates progress.



You can enter or modify a % completion value for a task in the following ways:

- Select the task and use one of the **Completion Level** icons  of the **Gantt Tools** tab.
- Move the cursor to the left of the task bar (or to the right end of the completion line if the task already has a completion value) until it changes to  % and drag rightwards or leftwards until the appropriate completion position is reached.
- Select the task and choose **Task Information**  to open its Task Information dialog. Select a value in the **Completion (%)** field.

- Select the task. On the **Task/Timeline** panel, select a value in the **Completion (%)** field.

### Hiding the bar of a task

If you are working on a large project plan, with many tasks, you might want to hide some of the task bars from the Gantt chart to improve its legibility and allow you to concentrate on some of the more important tasks.

To prevent the bar of a task to be displayed on the Gantt chart:

- Select the task and choose **Task Information**  to open its Task Information dialog. Check the option **Hide task bar in chart**.



The task stays listed in the Gantt Outline, but its bar is no longer shown in the Gantt chart.

### Making a task inactive

If you want to keep a task in your project plan, but prevent it from affecting its scheduling, you can make it inactive. This can be useful for instance if you are forced to remove some tasks from your project for budget or deadline reasons, but want to keep a record of them, in case you may be able to re-introduce them later if you get additional funding or extra time.

Once inactive, a task is no longer taken into account by the scheduling engine, which means that its dates, duration and any resources allocated to it no longer have any impact on any of the other tasks of the project plan.

You can inactivate a task in different ways:

- Select the task and click the **Inactivate Task** icon  of the **Gantt Tools** tab.
- Select the task and choose **Task Information**  to open its Task Information dialog. Check the option **Inactive**.
- Right-click the task name in the Gantt Outline and choose **Inactivate Task** in its local menu.

To reactivate an inactive task, just repeat one of these operations.

Inactive tasks are identified by a special indicator  in the Gantt Outline, and their task bar appears in white on the Gantt chart.





Inactivating a summary task automatically inactivates all its sub-tasks.

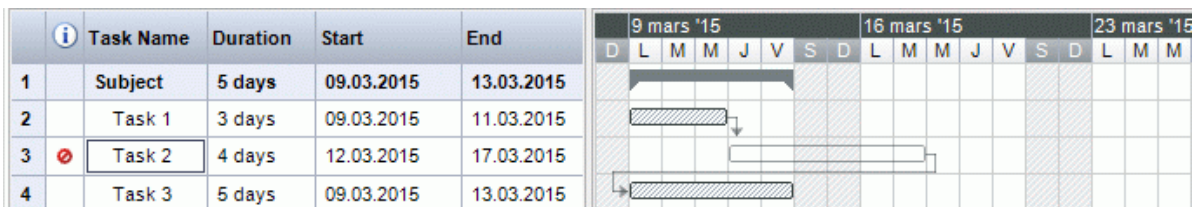
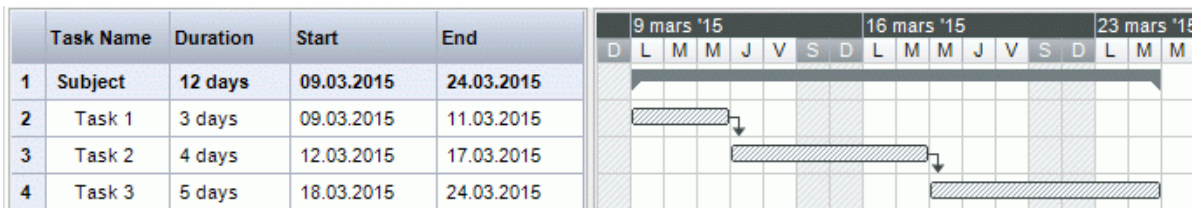

*Be careful when inactivating a task that is linked to other tasks. If you inactivate a task with successors, the successors will be re-scheduled as if that task had been deleted. If you want to keep the link between two tasks after inactivating their connecting task, you will need to re-link the two tasks manually.*





	 Task Name	Duration	Start	End
1	Subject	8 days	09.03.2015	18.03.2015
2	Task 1	3 days	09.03.2015	11.03.2015
3	 Task 2	4 days	12.03.2015	17.03.2015
4	Task 3	5 days	12.03.2015	18.03.2015

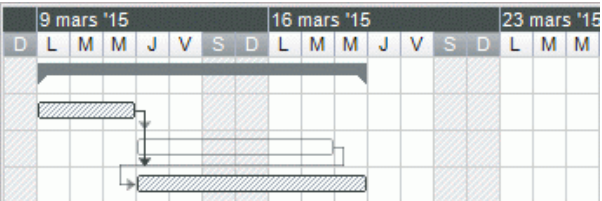

## Customizing the Gantt chart display

For more information about this, refer to the paragraph "Customizing the Gantt Chart" in the topic "[Using the Gantt view](#)".

## Reviewing a project plan

It's a good idea to review your project plan regularly in order to locate conflicts or other problems. You can then make appropriate changes to remove them.

## Checking deadlines

Have any tasks overshoot their deadline? If so, you will see red warning markers in the Indicators column:

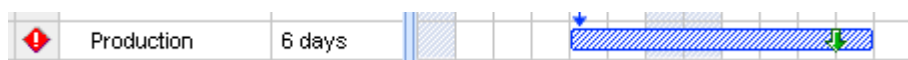

To overcome the problem you may need to reschedule tasks. Alternatively, if the overshoot is acceptable, you can change the deadline by opening the Task Information dialog (double-click the task bar) and assigning a new date. To remove the deadline altogether, remove the check mark from the Deadline field.

## Checking the project end date

Is the project on course? Check that the end date of your project looks reasonable.



When you are scheduling a project plan from its start date (see "[Defining the global project settings](#)"), MindView calculates the end date of the project automatically, on the basis of the task durations, the task dependencies and the project calendar.

You can check the project end date in several ways:

- View the end date of the first task in the project plan, either in the Gantt Outline or in the Gantt chart. This is the root summary task that covers the whole project.

	Task Name	Duration	Start	End
1	Painting work	14 days	19.01.15	05.02.15

- View the end date of the last task in the project plan, either in the Gantt Outline or in the Gantt chart.

 If the task bar of the last task is not visible in the Gantt chart, select the task in the Gantt Outline and click **Go to Selected Task**  on the Gantt Tools tab.

- Choose **Project | Project Information** on the Gantt Tools tab to view the start and end date of the overall project.

If the end date is too late, and the suggestions described in the following paragraphs cannot help, you may need to apply more resources to one or more tasks. For example, if you assign two people rather than one to a task, you should be able to halve its duration.

## Checking the project start date

If unconstrained tasks start later than you expect them to, check the project start date (choose **Project | Project Information** on the Gantt Tools tab).

In the following example, Task1 and Task2 actually start on the project start date, as they should. However, Task3 has a 'Must Start On' constraint that is *earlier* than the project start date. This

effectively extends the project backwards before its official start date. This also happens when a task is given a lead time that pushes its start date *before* the project start date.

The project start date is nevertheless maintained, and any new task you add is scheduled to start on the official start date.

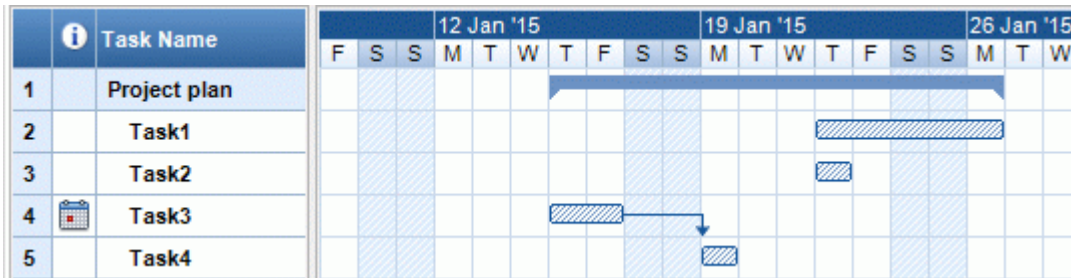

### Checking the dependencies

Are all the links between tasks necessary? By unlinking tasks that don't actually depend on each other, you will make use of all the slack time available, thereby shortening your schedule and maximizing its flexibility.

Alternatively, consider whether some tasks could overlap each other to reduce the overall duration of the project. If so, assign appropriate lead times (see "[Defining lead or lag time](#)" in the topic "[Using links](#)"). Another possibility is to redefine some of your 'Finish to Start' relationships to either 'Finish to Finish' or 'Start to Start' if the logic of your schedule allows it.

### Checking the constraints

Are the constraints working as you expect? Look in the Indicators column of the Gantt Outline for tasks that have constraint markers . If you have been adding an explanatory note to every constraint you set, read the notes to check that your intentions are still being met. And look for tasks that have a constraint but no note: these may have been created inadvertently and be causing trouble.

Do the tasks that have constraints fall where you expect them to? Do they fit logically with the other tasks around them? Check that their start and end dates are neither too early nor too late.

Look for unexpected overlaps or gaps (see below) between linked tasks: often this is caused by a rigid constraint on one or other of the tasks, in which case you should see a constraint marker in the Indicators column. However, remember that overlaps and gaps can also be caused by intentional lead or lag times. Displaying the Predecessors column in the Gantt Outline will allow you to check for the presence of lead or lag time.

Because constraints override links, they can introduce schedule conflicts, identified by the icon in the Indicators column. For example, in the following case, final changes are taking longer than expected, but the 'Must Finish On' constraint set on the printing task prevents it from moving out. The result is that printing is now scheduled to begin well before the final changes are complete.

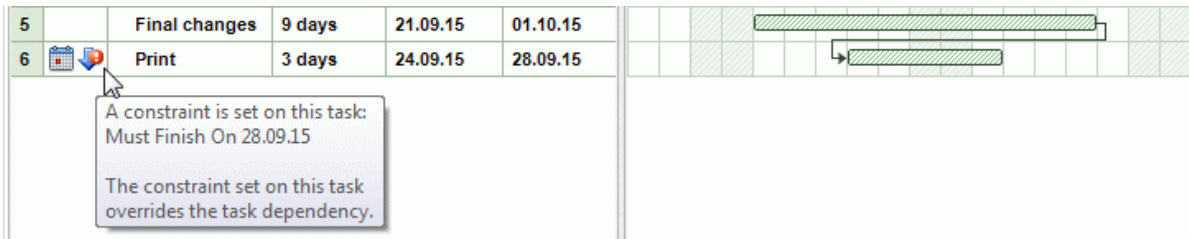

To resolve this problem, assuming that you want to maintain the end date of Sept 28th for printing:

- Double-click the task bar for the printing task to open its **Task Information** dialog.
- Remove the rigid constraint by unchecking the **Constraint** date checkbox and revert to the default 'As Soon As Possible' constraint. The link from "Final changes" will now determine the start of printing.

- In the **Deadline** field, select 28.09.15 to put a deadline marker on the printing task so that you are reminded of the required completion date. The deadline marker is simply a marker: it does not apply a constraint of any sort. Click OK to close the dialog.
- Shorten the time allowed for final changes (or one of its predecessor tasks), for example by assigning more people to the task, so that printing finishes on or before the deadline.

5	Final changes	4 days	17.09.15	22.09.15						[Gantt Bar]					
6	Print	3 days	23.09.15	25.09.15						[Gantt Bar]					↓

### Looking for gaps

Are there any gaps where work could be allocated but has not been? Gaps can occur when a rigid constraint has been applied to a task. The task's predecessor finishes early, leaving a gap (slack time). Because of the constraint, the task cannot move backwards to take advantage of the slack.

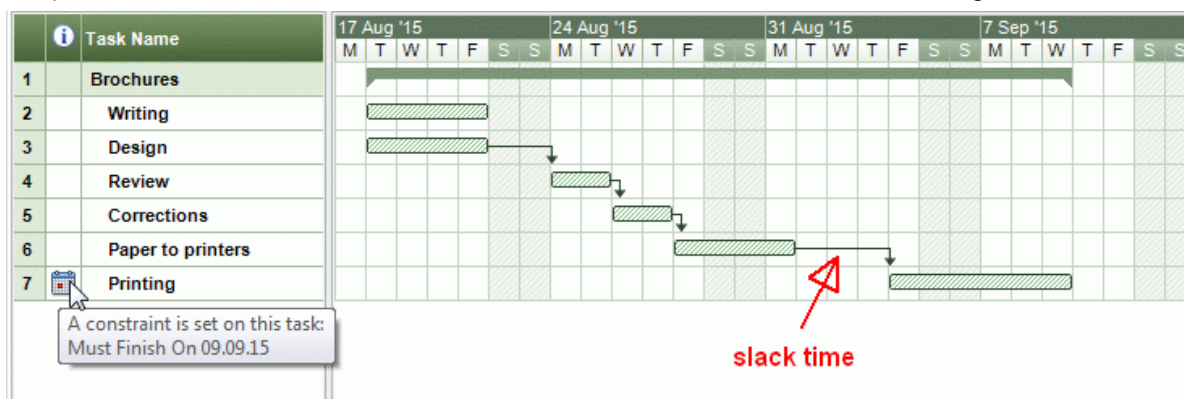

To overcome problems like this, and make use of the slack time, consider removing the rigid constraint and replacing it by the default 'As Soon As Possible'.

### Checking the critical path

Are there tasks on the critical path that should not be there? A task is on the critical path if it directly contributes to the duration of the project. Removing a task from the critical path will shorten the overall project.

- Choose **Show Critical Path** to highlight in red the tasks that are on the critical path.

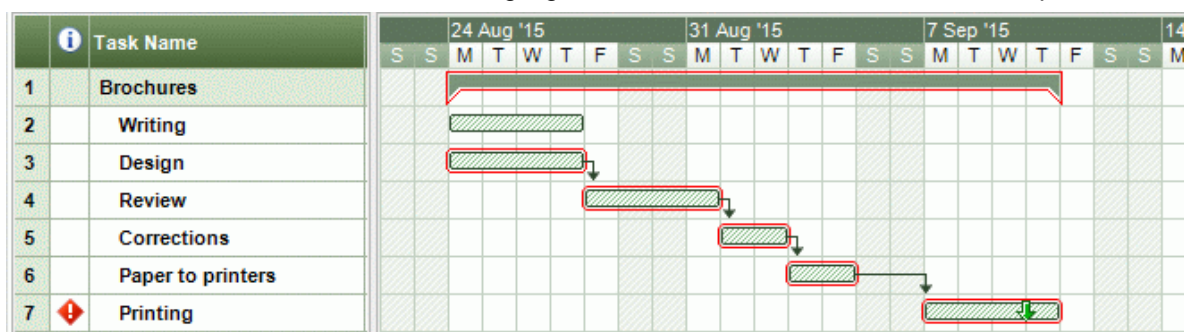

In this example, the "Paper to printers" task is on the critical path, but actually it could be done in parallel with the other tasks. The printing task is overshooting its deadline (green arrow), hence the red exclamation mark indicator. Taking the "Paper to printers" task off the critical path reduces the overall duration of the project and meets the deadline for completion of printing:

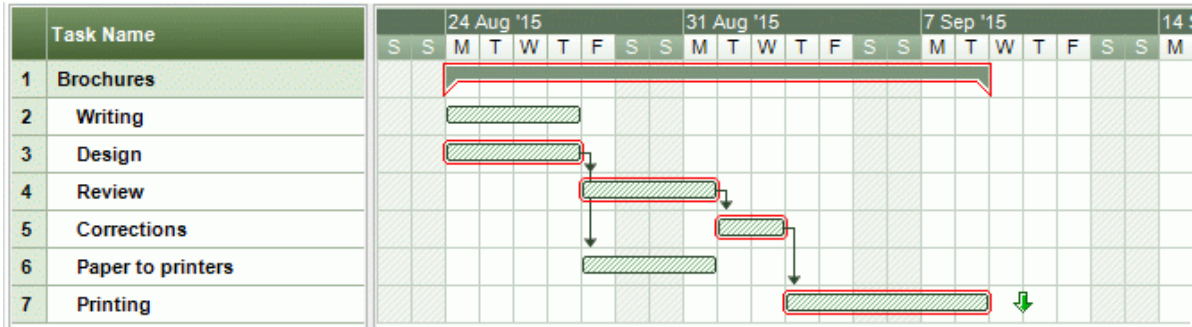

Redefining a 'Finish to Start' relationship to either a 'Finish to Finish' or a 'Start to Start' relationship is also a useful way of taking a task off the critical path.

### Filtering the tasks

One useful way of reviewing a project is to filter its tasks by appropriate criteria. For more information about how to define a filter, see "[Filtering a mind map](#)".

Using the Filter function, you can for instance display only the tasks that have a specific start or end date, duration, deadline, constraint, priority or completion level. You can also filter the project so that it only shows tasks involving particular resources.

The **Total slack** parameter lets you list only the tasks that are on the critical path (by specifying a value of zero), or tasks that have some slack in them, in other words that could be extended or delayed without affecting the end date of the project. To give an example, the condition "Total slack greater than 4" would only show you the tasks which could be delayed by 5 days or more without affecting the end date of the project. This could be very useful in helping you optimize the resource allocation, for instance by moving resources from tasks that have the most slack to more critical tasks.

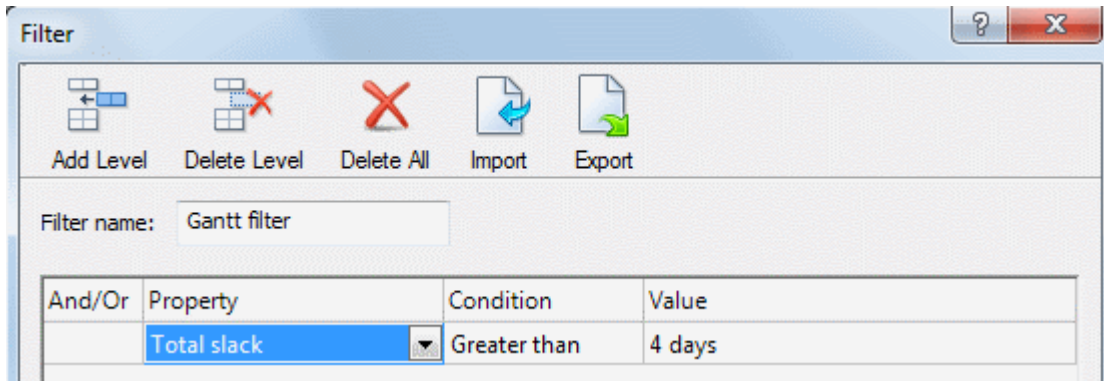

### Creating project reports



When working in the Gantt view, you can create a set of HTML reports from your project plan, such as Executive Reports, Task Status, Resources Workload and so on.

- Click the **Gantt Tools** tab.
- Choose **Project Reports**.
- Choose a folder and file name for the reports.  
The reports file opens in your Internet browser.
- Navigate through the options shown on the left-hand bar to display the corresponding report in the right-hand panel.



## Engineering project plan

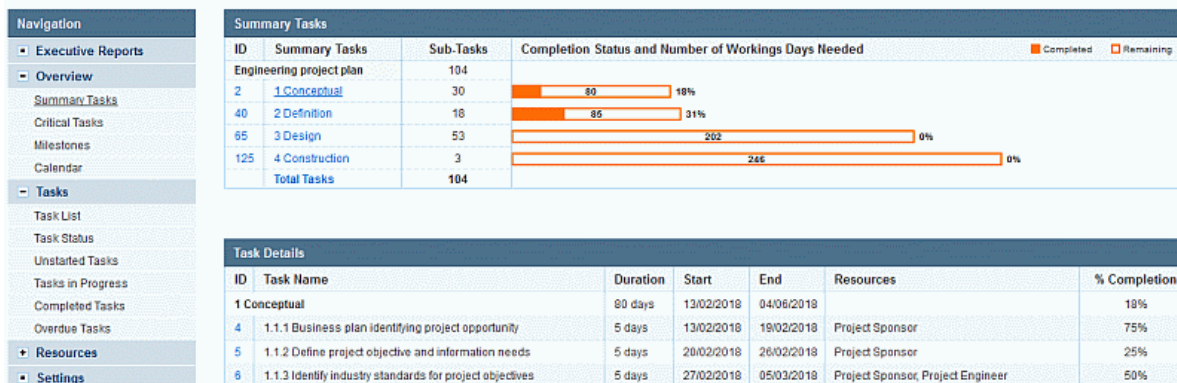

Many of these reports are interactive and let you navigate from one to the other. In many reports for instance, clicking a summary task in the upper part of the window displays all its sub-tasks in the bottom part. Similarly, clicking a Task ID in the bottom part opens the Task List, highlighting that task.

You can use the Back button of your browser to get back to the last report you were viewing at any point.

Most reports are self-explanatory. The following notes may however be useful:

- The **Overdue Tasks** report relies on Completion (%) data being up to date. For information on setting completion values, see "[Enhancing a project plan](#)".

A task is regarded as on schedule if it is marked as 100% completed, or if it is still in progress but marked as completed up to today's date (i.e. the date of the report). Otherwise it is overdue by the number of days between the end of its completion bar and today's date. A task in progress is also regarded as overdue if it has a deadline prior to today's date.
- The **Days with Multiple Tasks** report lists all the resources that have been allocated more than one task during the same period. For each day of the period, it shows the details of the multiple tasks that have been allocated to the resource.
- The **Resources Workload** and **Resources Accountability** reports show, for each resource, the hours required to complete the tasks they have been allocated, the hours available according to the project and resource calendars, and the difference between these two figures. The **Workload Index** charted at the top of the report gives a measure of the resource overload when the number of hours available is less than the number of hours required. The Accountability report also shows the number of overdue tasks.

## Exporting a project plan

All the export methods are available when working on a project plan. The export methods that are particularly relevant to project plans are the following:

**Creating reports:** Choosing this option in the Gantt Tools tab lets you create a number of different HTML reports, such as Top Level Tasks, Critical Tasks, Tasks in Progress and so on. See "[Creating project reports](#)" for more information.

**Export to HTML:** This export method is only available when you are viewing your project plan in a view other than the Gantt view. It lets you export your project plan as a standard web site. See "[Exporting to HTML](#)" for more information.

**Export to Microsoft Outlook:** This allows you to export your project plan as a series of tasks in the Outlook folder of your choice. For more information, see "[Exporting to Microsoft Outlook](#)".

**Export to Microsoft Project:** This allows you to take advantage of Microsoft Project's advanced project management capabilities to develop your project plan further. See "[Exporting to Microsoft Project](#)" for more information.

**Export to XML:** This method lets you export your project plan in two different XML formats, namely MindView XML and Microsoft Project XML. For more information, see "[Exporting to XML](#)".

## Printing a project plan



You can print your project plan in the same way as in the Map views.

MindView enables you to spread your printout on several pages, which is very useful in the case of project plans. Increasing both horizontal and vertical page spread values, for instance, will allow you to create a legible printout of your entire plan, spread over several pages.

For a full description of the printing options, see "[Printing a mind map](#)".

## Spellchecking

### Using the spellchecker



MindView allows you to find and correct spelling errors in your entire document as well as in the currently selected element. The MindView spellchecker is able to detect misspelled words and automatically correct common misspellings in the following elements:

- Branch names
- Floating comments
- Pop-up comments
- Text notes
- Object names

In addition to looking up words in its own dictionaries, the spellchecker also references **custom dictionaries** to determine whether a particular word is correctly spelt or not. You can customize these dictionaries by adding, replacing or deleting words.

The spellchecker also uses an **AutoCorrect list** to correct common mistakes automatically. Again, you can customize this list by adding, replacing or deleting word pairs.

Finally the spellchecker allows you to spellcheck your documents in **several languages**, including American and British English, French, German, Italian, Spanish, Dutch and Danish.

### Spellchecking as you type

By default, MindView checks for spelling errors as you type, underlining in red any mistakes found. You have the option of correcting the mistake straight away by right-clicking the misspelled word.

This opens the local menu, in which you can choose any of the following commands:

- Corrections
  - This lets you choose one of the suggestions listed, which then replaces the misspelled word.
- Ignore All
  - Choose this command to ignore the currently highlighted occurrence of the word and all other such occurrences in the document and any other document opened during this MindView session.
- Add to Dictionary
  - Choose this command to add the underlined word to your default custom dictionary, thereby making it a valid word which the spellchecker will no longer report as a mistake. See the topic "[Spellchecking options](#)" for more information on custom dictionaries.
- AutoCorrect
  - This lets you choose one of the suggestions listed. In addition, the misspelled word and its corrected equivalent will be added to the AutoCorrect list. This means that whenever you type this misspelled word in the future, it will be automatically replaced by its corrected equivalent. See the topic "[Spellchecking options](#)" for more information on the AutoCorrect list.
- Spelling
  - This opens the Spelling dialog, which allows you to spellcheck the entire selected element.

### Spellchecking the document

- Choose **Review | Proofing | Spellcheck Document** or press **F7**.



MindView goes through your document, examining branch names, floating comments, pop-up comments, text notes and object names for spelling mistakes. As soon as it detects a spelling mistake in one of these elements, MindView selects the element containing the mistake and opens the **Spelling** dialog.



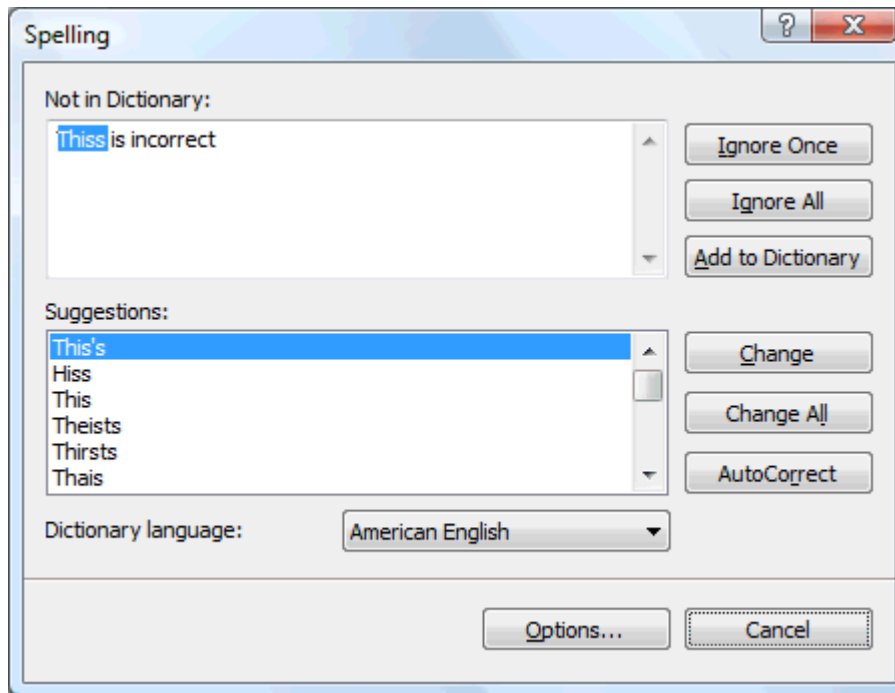

The top field shows the phrase containing the misspelling, with the first misspelled word highlighted. The bottom field shows a list of suggestions from which you can choose an alternative spelling for the highlighted word.

You can choose one of the following options:

- **Ignore Once**  
This will ignore the currently highlighted occurrence of the word.
- **Ignore All**  
This will ignore the currently highlighted occurrence of the word as well as any other such occurrences during the entire MindView session.
- **Add to Dictionary**  
This will add the misspelled word to your default custom dictionary.
- **Change**  
If you have edited the misspelled word in the top field, this replaces it with the edited word. Otherwise the misspelled word is replaced by the alternative spelling chosen in the Suggestions field. Only this occurrence of the misspelled word is corrected. If you also want all following occurrences of the word replaced, click Change All.
- **Change All**  
If you have edited the misspelled word in the top field, this replaces it with the edited word. Otherwise the misspelled word is replaced by the alternative spelling chosen in the Suggestions field. This replaces all the occurrences of the misspelled word in the entire document.
- **AutoCorrect**  
This replaces the misspelled word by the alternative spelling chosen in the Suggestions field. In addition, the misspelled word and its corrected equivalent are added to the AutoCorrect list.
- **Dictionary language**  
This lets you choose a different language for the spellchecker to use to check your document.
- **Options**  
This opens the Spellchecking Options dialog, which lets you set various options to control the way the spellchecking is done. See the topic "[Spellchecking options](#)" for a full description of this dialog.

## Spellchecking the currently selected element

- Choose **Review | Proofing | Spellcheck Selection** or press **Ctrl + F7**.



MindView goes through the currently selected element, looking for spelling mistakes. As soon as it detects a spelling mistake, MindView selects the phrase containing the spelling error, highlights the error and opens the Spelling dialog described above.

## Choosing a different dictionary

- Choose **Review | Proofing | Set Language** and select the language dictionary you would like to use to spellcheck your document.

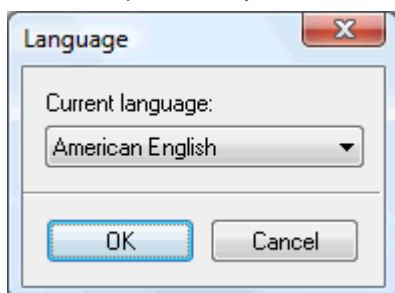

## Spellchecking options



This dialog contains various options which you can set to determine the type of errors reported by the spellchecker.

You can access it in several ways:

- By choosing **Review | Proofing | Spelling Options**.
- By clicking **Options** in the **Spelling** dialog.
- By clicking the **File** tab, then **MindView Options** and **Proofing**.

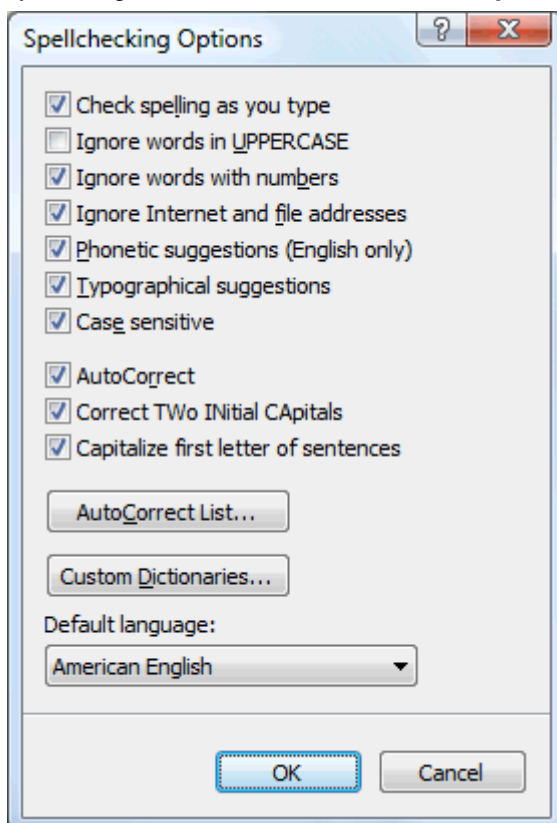

**Check spelling as you type:** If you disable this option, the misspelled words will not be automatically underlined in red as you type them. You will need to use the Spellcheck commands to spellcheck your mind map at a later stage.

**Ignore words in uppercase:** When enabled, this option causes any word written entirely in upper case to be ignored by the spellchecker and skipped. It is useful to keep this option enabled if your document contains many acronyms.

**Ignore words with numbers:** When enabled, this option causes any word containing numbers to be ignored by the spellchecker and skipped. It is useful to keep this option enabled if your document contains many words or symbols including numbers, such as Q4.

**Ignore Internet and file addresses:** When enabled, this option causes any words that appear to make up an Internet domain name, a URL or an email address to be ignored and skipped.

**Phonetic suggestions (English only):** When enabled, this option causes suggestions to be made on the basis of their phonetic similarity to the misspelled word. This option tends to improve suggestions for badly misspelled words.

**Typographical suggestions:** This is the default option. It causes suggestions to be made on the basis of the similarity of their spelling to that of the misspelled word. Note that the spellchecker does not offer suggestions if you disable both this option and the 'Phonetic suggestions' option.

**Case sensitive:** When enabled, this option causes the spellchecker to distinguish between capitalized and non-capitalized letters. The word "europe" for instance would be considered as a mistake. If you disable this option, "europe" and "Europe" would be considered identical and both regarded as correct.

**AutoCorrect:** If you disable this option, even if a misspelled word is included together with its correct equivalent in the AutoCorrect list, the misspelled word will not be automatically replaced by its equivalent.

**Correct two initial capitals:** If you type the first two letters of a word in upper case, this option causes the 2nd letter to be automatically converted from upper case to lower case. The word "EUrope" for instance would be automatically replaced by "Europe".

**Capitalize first letter of sentences:** Automatically converts the 1st letter of a sentence to upper case.

You can also click **AutoCorrect List** or **Custom Dictionaries** to open the corresponding dialogs. Both dialogs are described below.

**Default language:** This lets you choose the default language which you want the spellchecker to use to check your documents.

## Using the AutoCorrect list

This list contains all the misspelled words which you have corrected by using the AutoCorrect feature described above. Each line is made up of the originally misspelled word in the 'Replace' column on the left, together with the suggestion you chose to replace it with in the 'With' column on the right.

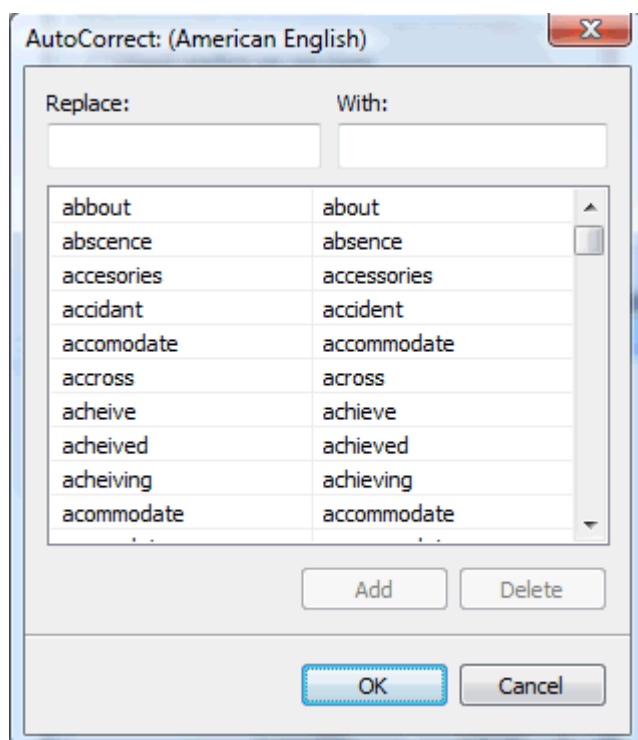

If you work with different languages, the spellchecker maintains one such AutoCorrect list per language.

You can customize the AutoCorrect list in various ways:

- You can add new AutoCorrect pairs by typing a commonly misspelled word in the 'Replace' field followed by its correct equivalent in the 'With' field and clicking **Add**.
- You can replace the correct equivalent of a misspelled word by selecting this misspelled word in the 'Replace' list, typing the new equivalent in the 'With' field and clicking **Replace**.
- You can delete an AutoCorrect pair by selecting the corresponding row in the list and clicking **Delete**.

### Using the custom dictionaries

This dialog contains a list of all your custom dictionaries as well as several buttons allowing you to customize them.

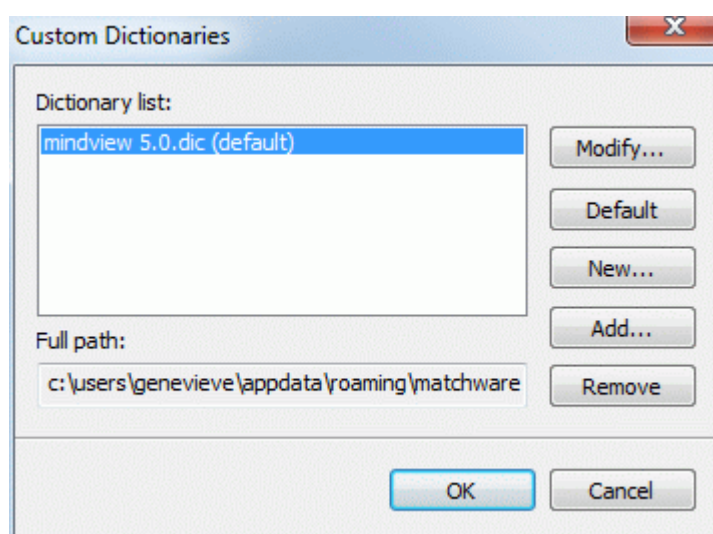

Custom dictionaries contain all the words reported as misspelled by the spellchecker that you decided to accept as valid by clicking Add to Dictionary during spellchecking. This means that a word included in any of the custom dictionaries is no longer reported as a misspelling by the spellchecker.

The Custom Dictionaries dialog allows you to:

- Modify one of the custom dictionaries by clicking it, then selecting **Modify**. You can then add new words to the dictionary or remove existing words.
- Set one of the custom dictionaries as default by selecting it and clicking **Default**. Any new word you now accept as valid by clicking Add to Dictionary while spellchecking will be automatically added to this dictionary.
- Create a new custom dictionary by clicking **New**.
- Add an existing custom dictionary by clicking **Add**.
- Remove an existing custom dictionary by selecting it and clicking **Remove**.

## Exporting

### Introduction



MindView lets you export your document to other applications, including Microsoft® Word, Microsoft® PowerPoint, Microsoft® Excel, MatchWare Mediator, Microsoft® Outlook and Microsoft® Project. You can also export it to HTML or XML, or as a PDF or RTF document.

These export possibilities mean that you can use MindView to brainstorm your ideas, organize them visually and collect all the associated material, and then convert the map into the format you require. In this way, you immediately obtain a professional-looking document, which you can process further if necessary using tools such as FrontPage® (for HTML export), Microsoft® Word, Microsoft® PowerPoint, Microsoft® Project, MatchWare Mediator and so on.

Once you have exported your document and worked on it in one of these applications (for instance Word, PowerPoint, Excel, Mediator, Outlook or Project), you can re-import it back into MindView if necessary, while preserving much of the work done in the external application. The branch structure, layout and contents of the original mind map is also preserved as far as possible. For more information about importing a document into MindView, see the "[Importing](#)" section of this documentation.

The export options offered by MindView are all described in detail in the next topics.

### Additional folders



When you export your document to one of the export formats available, MindView automatically includes and references all the files you have used in the document.

If however you have created a particular folder structure for the external files used by your document, you can ensure that MindView preserves this structure when exporting to HTML by specifying the list of folders that need to be included in the export folder as follows:

- Click the **File** tab.
- Choose **Prepare | Additional Folders** to open the following dialog:

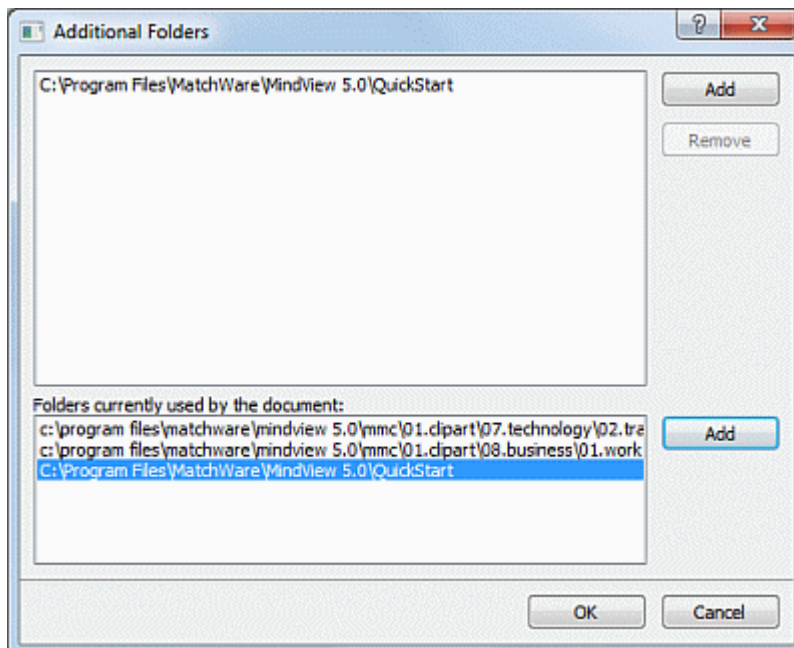

- Click the **Add** button and select the first folder you wish to include in the export.
- Repeat for all the folders you would like to include.

Note that you can enlarge the dialog by dragging one of its corners if the folder paths are not fully visible.

In the exported version of your document, all references to external files are automatically modified to point to the correct output folder.

## Exporting to Microsoft Word



This export method lets you export your mind map as a Microsoft® Word document. If for instance you have created a mind map to brainstorm the structure of a report, this export mode provides you with a ready-made outline of your map as a Word document, which you can then turn into a fully blown report by working directly in Word.

If after working for some time on your Word document, you realize you need to review the structure of your map in MindView before doing any further work in Word, you can re-import it back into MindView without losing any new text or formatting you might have added in Word. See "[Importing from Microsoft Word](#)" for more information.



You do not need to have Microsoft Word installed on your computer in order to use this export mode. However, on versions of Windows prior to Windows 7, you need Word 2007 and above to open the exported document. You can also open the document in an earlier version of Word if you have installed the Microsoft Office Compatibility pack, available free from the Microsoft web site. From Windows 7 you can open .docx files directly in the default editor in Windows without having Word installed, although some of the more advanced content of the docx file cannot be shown.

Each branch is exported as a paragraph heading at the relevant level, in other words Heading 1 for main branches, Heading 2 for sub-branches, Heading 3 for sub-sub-branches and so on, using hierarchical numbering (unless you disable it in Advanced Export). Attached objects and inserted elements are listed below the heading.



As Microsoft Word only supports 9 heading levels, any MindView branch deeper than 9 levels is exported as Heading 9.

By default, MindView automatically includes an overall picture of your map on the first page of the document, followed by a Table of Contents.



*If you add new headings to the document when working directly in Microsoft Word, you can easily update this Table of Contents by right-clicking it and choosing Update Field in the Word local menu. If you don't need the Table of Contents, you can delete it by selecting it and pressing Delete.*

The branches of the map are exported to Word in the order in which they are displayed in the Mind Map view, starting from the top right in a clockwise direction.

You can however exclude entire branches and sub-branches from the export by disabling their 'Include in export' property in the Properties dialog.

Include in Export	<input checked="" type="checkbox"/>
-------------------	-------------------------------------



*Only the branches displayed on the workspace when you start the export procedure are exported. This means that if you are focusing on a particular branch or set of branches (see "[Focusing on a branch](#)") or if you are filtering the map to display only branches that meet specific criteria (see "[Filtering a mind map](#)"), only the branches visible on the workspace will be exported. To export the entire map, you need to go back to the full display by clearing the branch focus or filter applied.*

### Export modes

There are two export modes available:

- **Quick Export**



The Quick Export mode allows you to export your map quickly using the MindView defaults or the last Advanced Export settings you chose if you have already used that mode.



## ● Advanced Export



The Advanced Export mode allows you to choose a template for your Word document. You can also specify the elements of your map to be exported and how they should be treated.

The export settings you choose in Advanced Export are saved with the MindView document and re-used next time you export your map using Quick Export or Advanced Export. This means you do not have to redefine them every time you make a small alteration to your map and want to export it again to Word.



*When exporting a mind map to Word, MindView inserts bookmarks in the Word document to keep track of how the various elements should be re-imported back into MindView if you choose to do so. You should take care not to delete these bookmarks, which are hidden by default. To make them visible while you work, check 'Show bookmarks' in the Advanced panel of the Word Options dialog.*

### Relationship between MindView and Word elements and objects

The following table indicates how MindView treats the various inserted elements and attached objects contained in your map when exporting it to Microsoft Word.

MindView element	Exported to Word as
Branch name	Heading at relevant level with hierarchical numbering (3 levels by default) Hierarchical numbering can be disabled in Advanced Export.
Text note	Text inserted under the branch heading
Branch picture	Picture inserted under the branch heading
Floating picture	<ul style="list-style-type: none"> <li>● If connected to a branch, inserted under the branch heading</li> <li>● If not connected to a branch, not exported</li> </ul>
Floating comment	As for Floating picture
Pop-up comment	Word comment on the branch heading
Branch connection	Cross-reference prefixed by "See" under the start branch heading, pointing to the end branch heading
MindView object	Exported to Word as
Text file	Hyperlink
Picture file	Picture inserted in the Word document In Advanced Export, you can choose instead to insert the file as a hyperlink.
Video file	Hyperlink
Sound file	Hyperlink
Hyperlink	Hyperlink
Flash file	Hyperlink

### Using Quick Export

- Click the **File** tab.
- Choose **Export | Microsoft Word | Quick Word Export**.
- If your MindView view contains several maps (i.e. several roots), choose the map you want to export in the 'Select Map to Export' dialog and click OK.
- Specify a folder and a file name for the new Word document in the Save As dialog.

MindView starts exporting your mind map to Microsoft Word and displays a message informing you that export is complete.

- Click OK in that dialog to open the document in Word.

Word then displays the following message, indicating that it needs to update the Table of Contents.

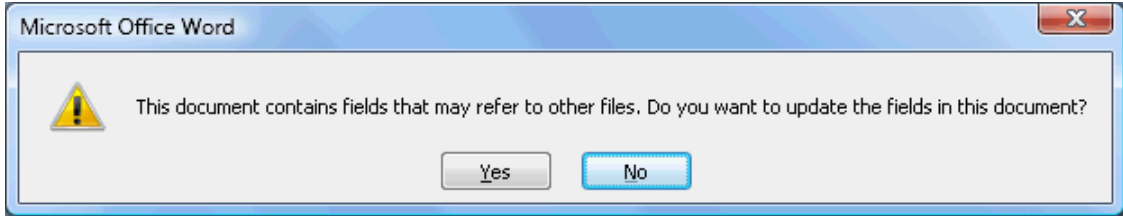

- Click OK to update the Table of Contents.

You are now ready to work in your Word document.

### Using Advanced Export

- Click the **File** tab.
- Choose **Export | Microsoft Word | Advanced Word Export**.
- If your MindView view contains several maps (i.e. several roots), choose the map you want to export in the 'Select Map to Export' dialog and click OK.
- Choose your preferred template in the **Templates** tab of the Advanced Microsoft Word Export dialog or browse for one of the templates supplied with Microsoft Word or one of your own templates.

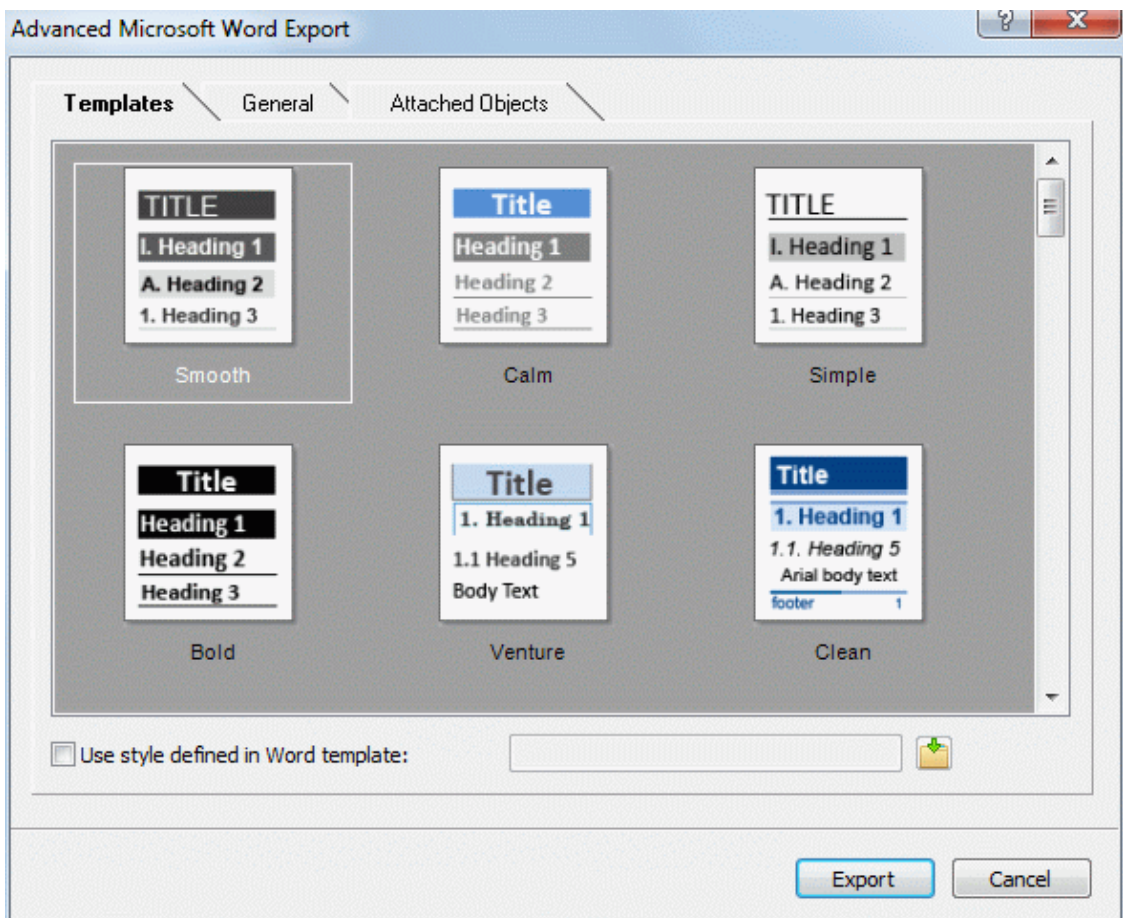

The APA and MLA templates supplied with MindView are designed to help you format your documents according to the APA (American Psychological Association) and MLA (Modern Language Association) standards, commonly used in the United States. The MLA template

contains further styles which you can use when finalizing your document, such as "block quotes" and "works cited".



You can easily define your own Word template to be used when exporting from MindView. All you need to do is to define the Title style as well as styles for Headings 1 to 9 and save the document as a Word template (.dotx or .docx). You must also make sure the template does not contain any text.

- In the **General** tab, choose the required general export settings and specify which elements of your map you want to export.

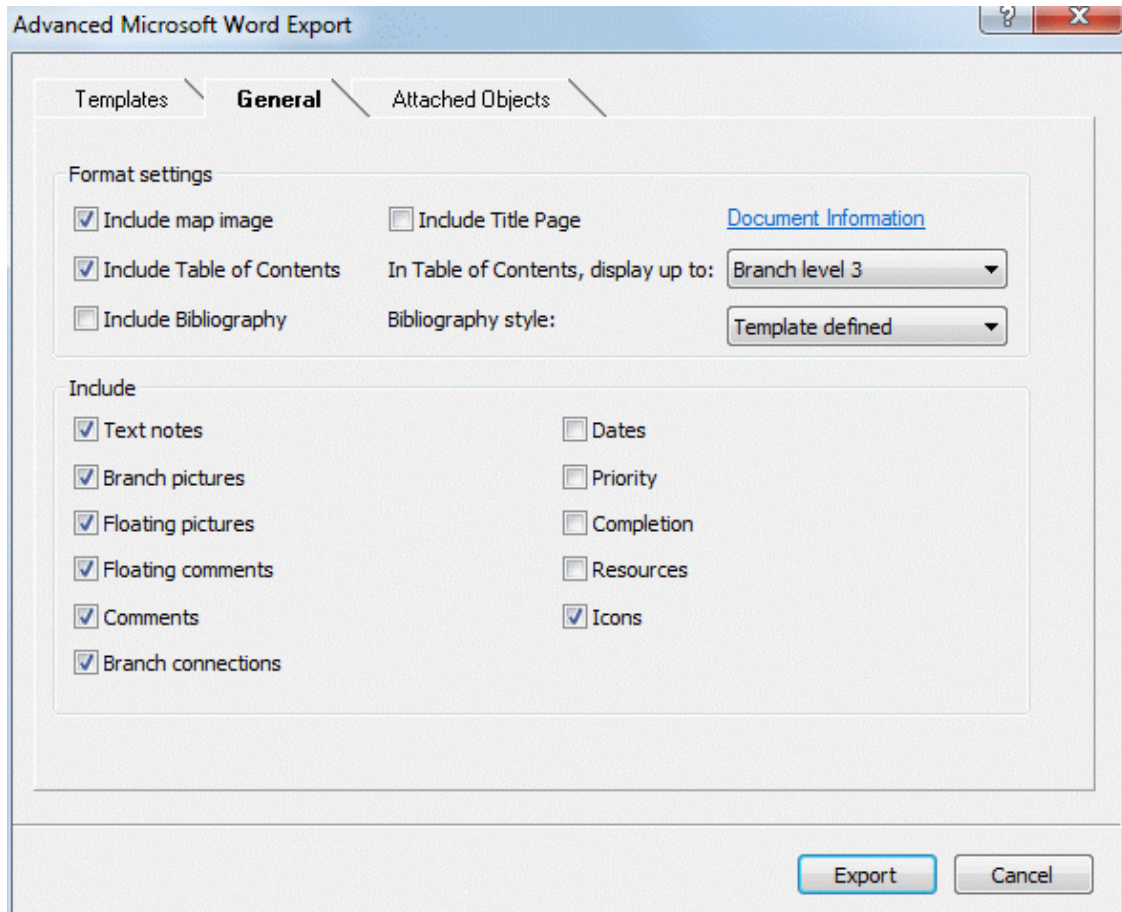

The export of bibliography sources and citations is only supported from Microsoft® Office 2007. For more information about this topic, see "[Using sources](#)" and "[Using citations](#)".



If you exclude some elements from the export by deselecting them here, none of the elements of this type will be exported, regardless of the value of their individual 'Include in export' property in the Properties dialog. Let's suppose for instance your map contains a floating picture whose 'Include in export' property is enabled. If you choose to exclude floating pictures from the export here, your floating picture will not be exported. Conversely, if you specify here that floating pictures should be exported, only the floating pictures whose 'Include in export' property is enabled will be exported.



- Choose the required export settings for any attached object in the **Attached Objects** tab.



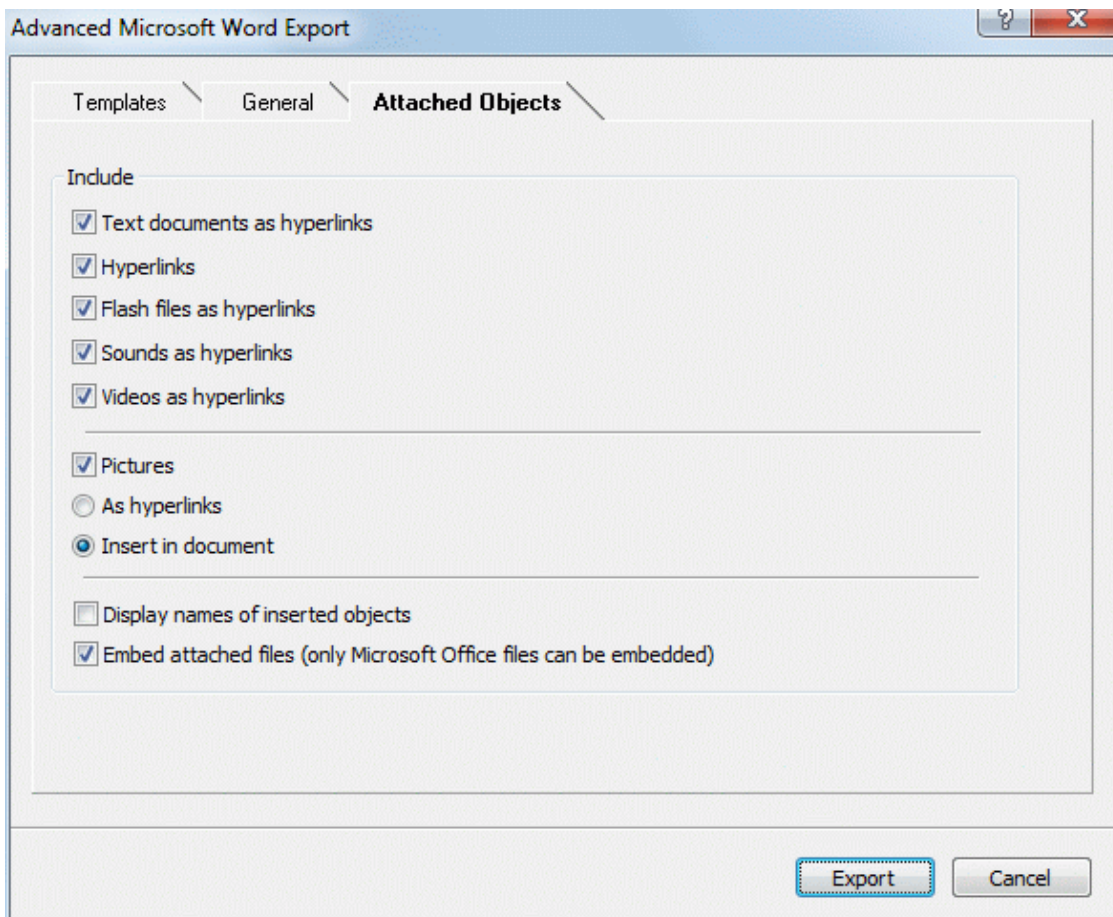

- Click **Export**.
- Specify a folder and a file name for the new Word document in the Save As dialog.

 If you had left the option **Embed attached files** above checked and your map contains attached files that cannot be embedded in the Word document, you will be prompted to choose a folder where to copy these attached files to avoid overwriting files with the same name in the destination folder.

As for Quick Export, MindView starts exporting your mind map to Microsoft Word as a new document and displays the same messages once the export is complete.

## Exporting to Microsoft PowerPoint



This export method lets you export your mind map as a Microsoft® PowerPoint presentation. If for instance you have created a mind map to brainstorm the structure of a business presentation, this export mode allows you to transfer it to PowerPoint in order to refine it further before delivering it to your audience.

If after working for some time on your PowerPoint presentation, you realize you need to review the structure of your map in MindView before doing any further work in PowerPoint, you can re-import it back into MindView without losing the layout work done in PowerPoint. See "[Importing from Microsoft PowerPoint](#)" for more information.

 You must have Microsoft PowerPoint installed on your computer in order to use this export mode. MindView supports all Microsoft PowerPoint versions from 2000 onwards.

The root makes up the first slide, with the root label as the slide heading, followed by a list of the main branches.

Each branch is then exported as a slide, with any sub-branches listed below the slide heading. Inserted elements and hyperlinks are placed on the right side or at the bottom of the slide.

The branches of the map are exported to PowerPoint in the order in which they are displayed in the Mind Map view, starting from the top right in a clockwise direction.

You can however exclude entire branches and sub-branches from the export by disabling their 'Include in export' property in the Properties dialog.

Include in Export	<input checked="" type="checkbox"/>
-------------------	-------------------------------------

 Only the branches displayed on the workspace when you start the export procedure are exported. This means that if you are focusing on a particular branch or set of branches (see "[Focusing on a branch](#)") or if you are filtering the map to display only branches that meet specific criteria (see "[Filtering a mind map](#)"), only the branches visible on the workspace will be exported. To export the entire map, you need to go back to the full display by clearing the branch focus or filter applied.

## Export modes

There are two export modes available:

- **Quick Export**



The Quick Export mode allows you to export your map quickly using the MindView defaults or the last Advanced Export settings you chose if you have already used that mode.

- **Advanced Export**



The Advanced Export mode lets you choose a PowerPoint template for your presentation. It also allows you to specify the elements of your map to be exported and how they should be treated.

The export settings you choose in Advanced Export are saved with the MindView document and re-used next time you export your map using Quick Export or Advanced Export. This means that you do not have to redefine them every time you make a small amendment to your map and want to export it again to PowerPoint.

## Relationship between MindView and PowerPoint elements and objects

The following table indicates how MindView treats the various inserted elements and attached objects contained in your map when exporting it to PowerPoint.

MindView element	Exported to PowerPoint as
Branch name	Slide heading
Text note	Text object Due to PowerPoint limitations, if the text note contains tables or bulleted lists, these elements will be exported as regular text. Similarly, if the text note contains a hyperlink, the formatting of the hyperlink will be preserved, but not the link itself.
Branch picture	Picture on the right of the slide In Advanced Export, you can choose instead to insert the branch picture as a hyperlink.
Floating picture	<ul style="list-style-type: none"> <li>● If connected to a branch, inserted as a picture on the right or at the bottom of the slide</li> <li>● If not connected to a branch, not exported</li> </ul>
Floating comment	<ul style="list-style-type: none"> <li>● If connected to a branch, inserted on the slide as a PowerPoint comment</li> <li>● If not connected to a branch, not exported</li> </ul>

Pop-up comment	PowerPoint note in the bottom Notes pane
Branch connection	Hyperlink in a text object
<b>MindView object</b>	<b>Exported to PowerPoint as</b>
Text file	Hyperlink in a text object
Picture file	Picture on the right or at the bottom of the slide In Advanced Export, you can choose instead to insert the file as a hyperlink in a text object
Video file	Hyperlink in a text object In Advanced Export, you can choose instead to embed the video directly on the slide
Sound file	Hyperlink in a text object
Hyperlink	Hyperlink in a text object
Flash file	Hyperlink in a text object

### Using Quick Export

- Click the **File** tab.
- Choose **Export | Microsoft PowerPoint | Quick PowerPoint Export**.
- If your MindView view contains several maps (i.e. several roots), choose the map you want to export in the 'Select Map to Export' dialog and click OK.

MindView starts exporting your mind map to Microsoft PowerPoint as a new presentation, and displays a message once the export is complete. You can then start working directly in PowerPoint on your new presentation and save it with the name of your choice.

### Using Advanced Export

- Click the **File** tab.
- Choose **Export | Microsoft PowerPoint | Advanced PowerPoint Export**.
- If your MindView view contains several maps (i.e. several roots), choose the map you want to export in the 'Select Map to Export' dialog and click OK.
- Choose your preferred template in the **Templates** tab of the Advanced Microsoft PowerPoint Export dialog or browse for one of the templates supplied with Microsoft PowerPoint.

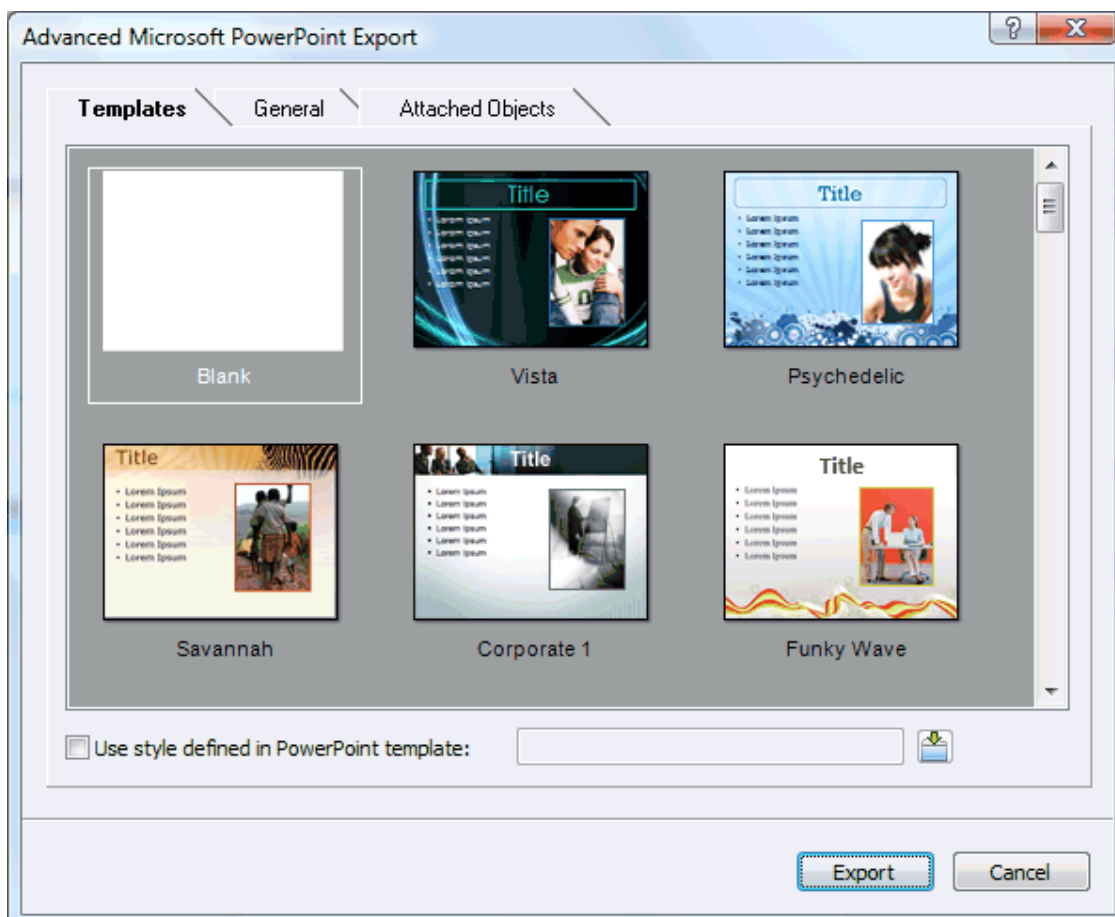

- In the **General** tab, choose the required general export settings and specify which elements of your map you want to export.



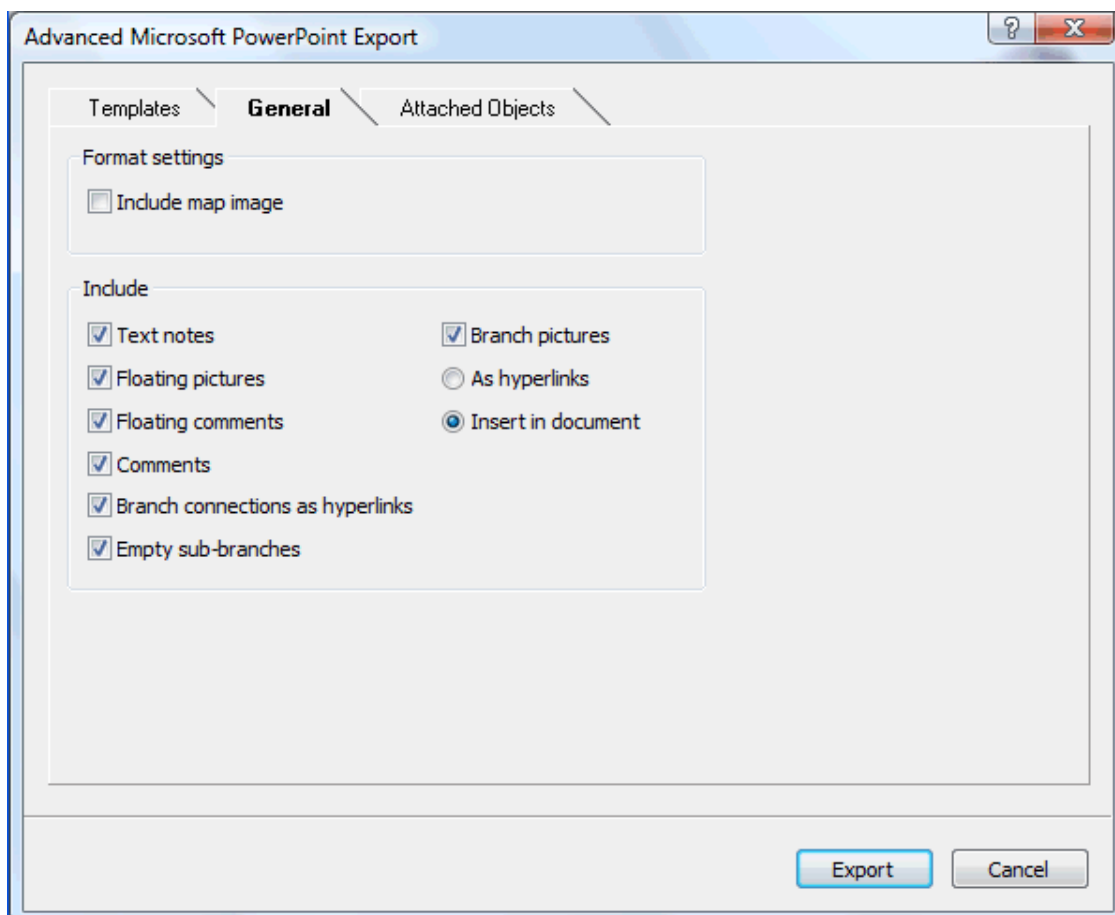

 If you exclude some elements from the export by deselecting them here, none of the elements of this type will be exported, regardless of the value of their individual 'Include in export' property in the Properties dialog. Let's suppose for instance your map contains a floating picture whose 'Include in export' property is enabled. If you choose to exclude floating pictures from the export here, your floating picture will not be exported. Conversely, if you specify here that floating pictures should be exported, only the floating pictures whose 'Include in export' property is enabled will be exported.

Include in Export

- Choose the required export settings for any attached object in the **Attached Objects** tab.

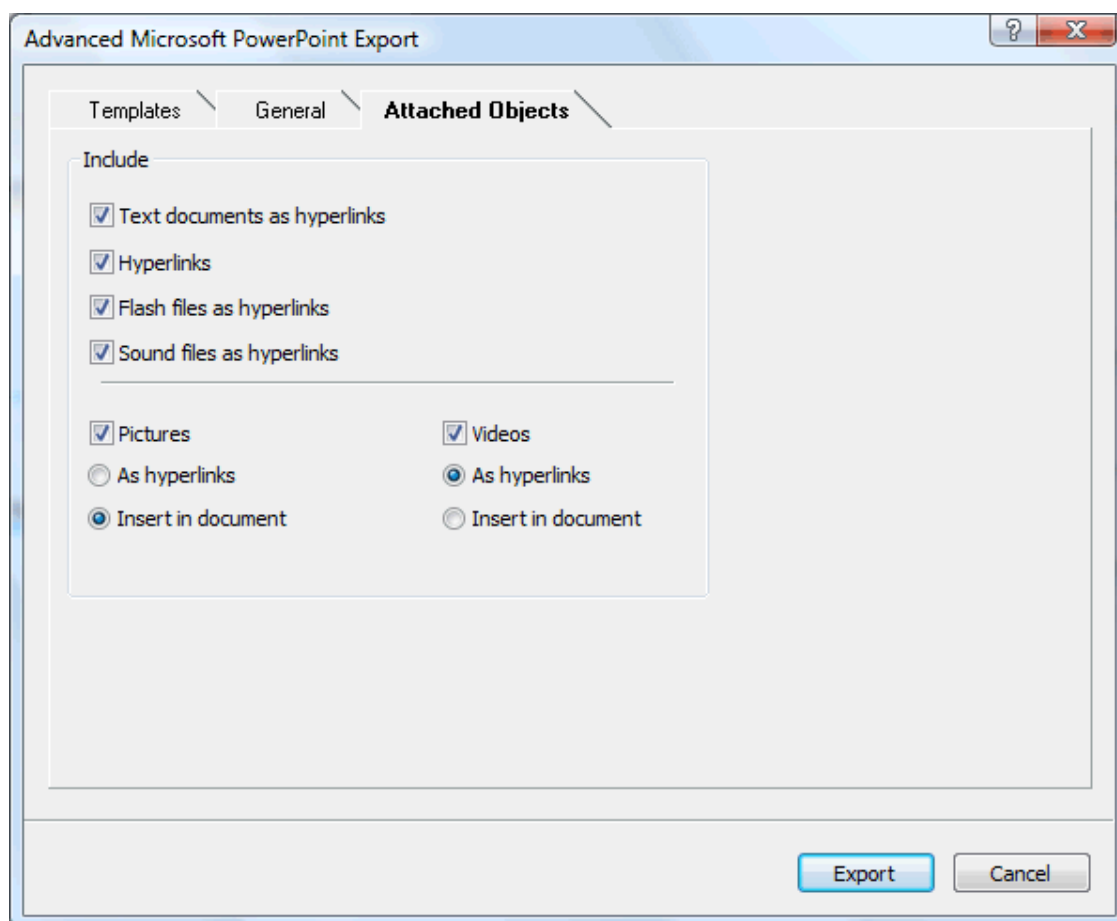

- Click **Export**.

As for Quick Export, MindView starts exporting your mind map to PowerPoint as a new presentation, and displays a message once the export is complete.

## Exporting to Microsoft Excel



This export method lets you export your mind map as a Microsoft® Excel spreadsheet document.

If for instance you have created a mind map to track worldwide sales, this export mode provides you with a ready-made version of your map as an Excel spreadsheet, which you can then turn into a fully blown report by working directly in Excel.

After working in Excel you can of course re-import the spreadsheet back into MindView: the re-imported mind map will reflect the changes you made in Excel. See "[Importing from Microsoft Excel](#)" for more information.



You must have Microsoft Excel 2003 or above installed on your computer in order to use this export mode. If you are using Excel 2010, you need to have the Microsoft .NET Client Framework 4.0 installed. Otherwise the export creates an Excel spreadsheet XML file.

Branch text, text notes, pop-up comments and calculation values are exported (see "[Inserting calculation values](#)" for information about calculation values). If you use the Advanced Export option, you can also export any or all of the standard task data fields such as Start, End, Duration, Completion, Priority, Resources and so on (see "[Inserting task data](#)" for more information on this topic).

The following are not exported: pictures, floating comments, attached objects, and dates before 1900 (which are not supported by Excel).



If you are focusing on a particular branch or set of branches (see "[Focusing on a branch](#)") or if you are filtering the map to display only branches that meet specific criteria (see "[Filtering a mind map](#)"), only the branches visible on the workspace will be visible in the Excel spreadsheet created. The same applies if you deselect the 'Include in Export' property in the Properties dialog for one or more branches. The branches that are not visible on the workspace are exported (because they may contain data needed by calculations on the visible branches), but the rows containing them are hidden. You can display these rows using the standard Excel procedures, for example in Excel 2007 select the rows above and below the hidden one(s) then, in the Home tab, choose Format and Hide & Unhide | Unhide Rows.

## Export modes

There are two export modes available:

- **Quick Export**



The Quick Export mode allows you to export your map quickly using the MindView defaults or the last Advanced Export settings you chose if you have already used that mode.

- **Advanced Export**



The Advanced Export mode allows you to choose a template for your Excel spreadsheet document. You can also specify the elements of your map to be exported and a layout for the output.

The export settings you choose in Advanced Export are saved with the MindView document and re-used next time you export your map using Quick Export or Advanced Export. This means you do not have to redefine them every time you make a small alteration to your map and want to export it again to Excel.

## Using Quick Export

- Click the **File** tab.
- Choose **Export | Microsoft Excel | Quick Excel Export**.
- If your MindView view contains several maps (i.e. several roots), choose the map you want to export in the 'Select Map to Export' dialog and click OK.
- Specify a folder and a file name for the new Excel document in the Save As dialog.

MindView starts exporting your mind map to Microsoft Excel and displays a message informing you that export is complete.

- Click OK in that dialog to open the document in Excel.

## Using Advanced Export

- Click the **File** tab.
- Choose **Export | Microsoft Excel | Advanced Excel Export**.
- If your MindView view contains several maps (i.e. several roots), choose the map you want to export in the 'Select Map to Export' dialog and click OK.
- Choose your preferred template in the **Templates** tab of the Advanced Microsoft Excel Export dialog.

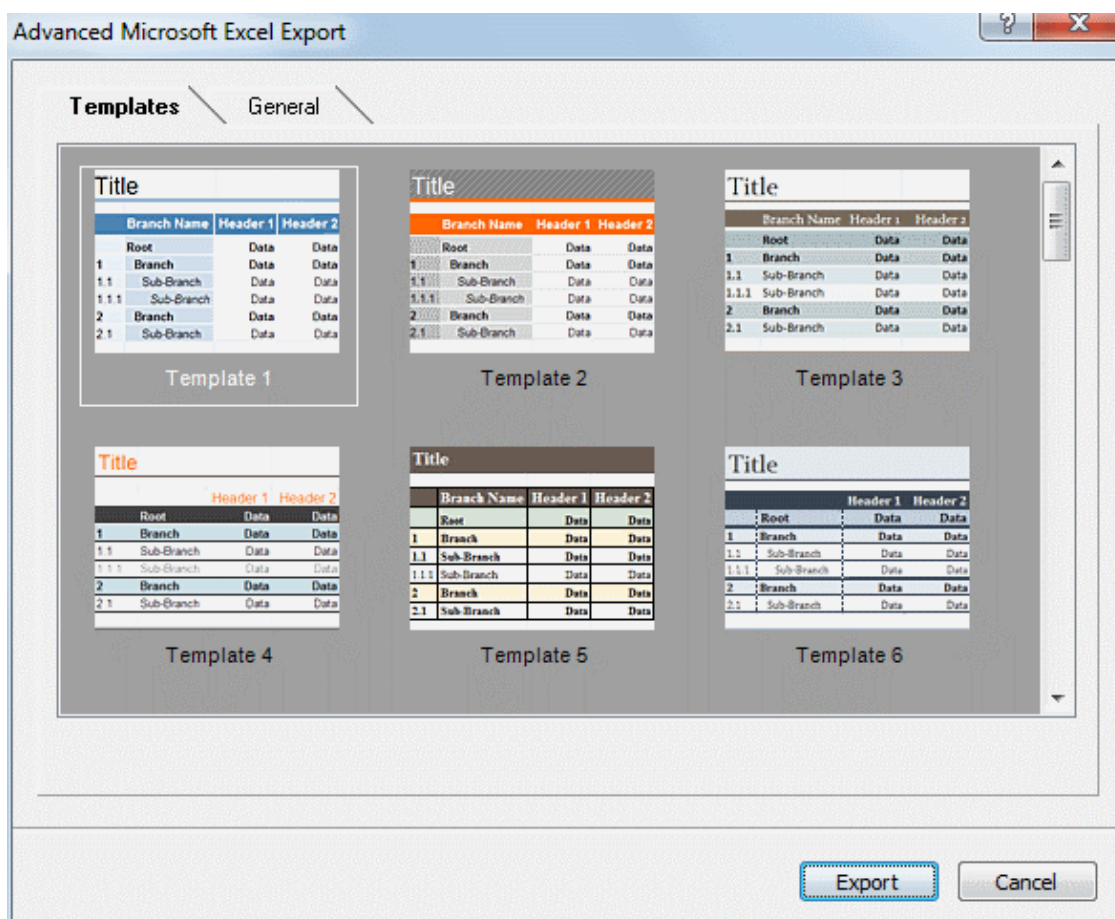

- In the **General** tab, choose a layout for the Excel spreadsheet:
  - In the **Numbered** layout, numbers in the leftmost column indicate the mind map hierarchy.
  - In the **Structured** layout, branch text is put into different columns according to the hierarchy of the branches in the mind map.

You can also specify the branch data and calculation values you want to export.

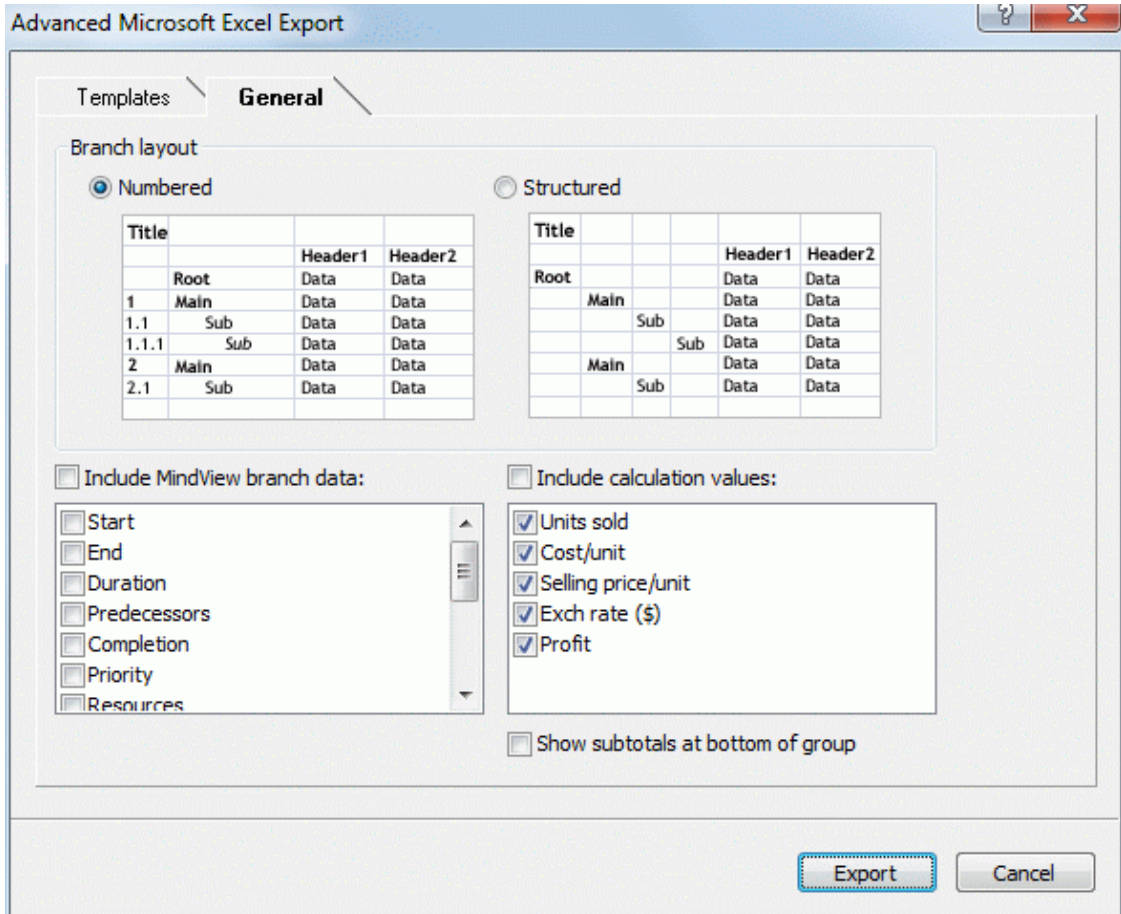

When exporting to Microsoft Excel, the root branch is normally listed first at the top of the spreadsheet, with the main branches listed before their sub-branches. This means that subtotals and totals appear *above* the data they are calculated from, like this:

		Units sold	Profit
<b>Sales of Units</b>		<b>60,952</b>	<b>\$ 113,222</b>
<b>North America</b>		<b>27,956</b>	<b>\$ 49,946</b>
	US	25,456	\$ 45,821
	Canada	2,500	\$ 4,125
<b>Europe</b>		<b>12,884</b>	<b>\$ 30,273</b>
	Germany	5,632	\$ 13,201
	UK	7,252	\$ 17,071
<b>Asia</b>		<b>17,100</b>	<b>\$ 29,212</b>
	Japan	8,100	\$ 17,062
	China	9,000	\$ 12,150
<b>Other</b>		<b>3,012</b>	<b>\$ 3,792</b>
	Brazil	3,012	\$ 3,792

If you want to see subtotals and totals *below* the data they are calculated from, select **Show subtotals at bottom of group**. The result looks like this:

		Units sold	Profit
	US	25,456	\$ 45,821
	Canada	2,500	\$ 4,125
<b>North America</b>		<b>27,956</b>	<b>\$ 49,946</b>
	Germany	5,632	\$ 13,201
	UK	7,252	\$ 17,071
<b>Europe</b>		<b>12,884</b>	<b>\$ 30,273</b>
	Japan	8,100	\$ 17,062
	China	9,000	\$ 12,150
<b>Asia</b>		<b>17,100</b>	<b>\$ 29,212</b>
	Brazil	3,012	\$ 3,792
<b>Other</b>		<b>3,012</b>	<b>\$ 3,792</b>
<b>Sales of Units</b>		<b>60,952</b>	<b>\$ 113,222</b>

 The **Show subtotals at bottom of group** option is only active when your mind map contains calculation data.

- Click **Export**.
- Specify a folder and a file name for the new Excel document in the Save As dialog.

MindView starts exporting your mind map to Microsoft Excel and displays a message informing you that export is complete.

- Click OK in that dialog to open the document in Excel.

## Exporting to Microsoft Outlook



MindView lets you export your document to Microsoft® Outlook as tasks in an Outlook task folder. If, for instance, you have brainstormed a task list in the Mind Map view or the Outline view, you can then export it to Microsoft Outlook if you prefer to track tasks from there.

As well as exporting the tasks into your own Outlook task folder, you can also choose to have them distributed automatically via email to the Outlook task folders of the other resources involved in the tasks, who can then accept or refuse them. This lets you use Outlook to track the status of all the exported tasks, just as you would if you had created the tasks directly in Outlook.

You can export your document to Microsoft Outlook even if the branches do not contain dates or other task information. This lets you brainstorm the task names in MindView and only add the rest of the task information once the document is transferred to Outlook.

 *Only the branches displayed on the workspace when you start the export procedure are exported. This means that if you are focusing on a particular branch or set of branches (see "[Focusing on a branch](#)") or if you are filtering the map to display only branches that meet specific criteria (see "[Filtering a mind map](#)"), only the branches visible on the workspace will be exported. To export the entire map, you need to go back to the full display by clearing the branch focus or filter applied.*

MindView also lets you import task lists from Microsoft Outlook. For more information, see "[Importing from Microsoft Outlook](#)".

 You must have Microsoft Outlook 2000 or above installed on your computer in order to use this export mode.

### Procedure

- Click the **File** tab.
- Choose **Export | Microsoft Outlook | Export as New Tasks**.



 If you have already exported the MindView document to Outlook previously, or if you have created the MindView document by importing an Outlook task list, you will be given the option of synchronizing the MindView document with the Outlook folder you specified at that time rather than creating new tasks. See below for more information on this procedure.

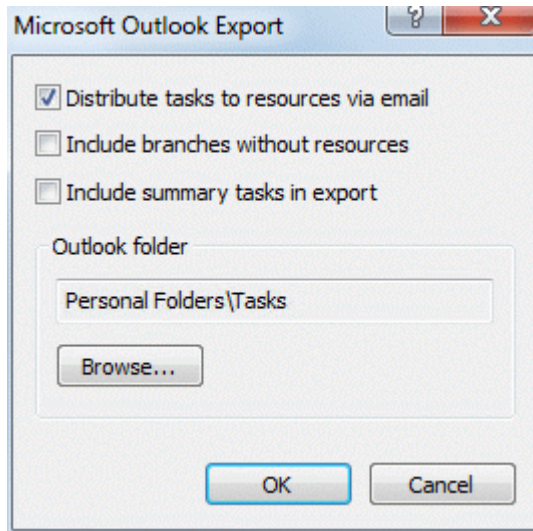

- (optional) Check **Distribute tasks to resources** if you want the tasks to be sent automatically via email to all the resources involved, who can then accept or refuse them, as they would any other task allocated to them directly from Outlook.

 As task distribution relies on email, you need to ensure that you have specified an email address for each resource. If a resource has several email addresses, this needs to be their default email address. For more information about entering email addresses for resources, see "[Assigning resources](#)".

 When choosing this option and depending on the security settings of your computer, you may get a warning from Outlook which you will need to acknowledge to enable the procedure to complete.

- (optional) Indicate whether you want to export all the tasks (i.e. branches), or only those that contain resources.
- (optional) Indicate whether you want to export the summary tasks of your Gantt projects, or only the tasks themselves.
- Select the Outlook task folder or sub-folder where you want to export the tasks.

 If you have chosen to distribute the tasks to the resources, you need to export the tasks to the Outlook default task folder, and not a sub-folder. If you export the tasks to a task sub-folder, Outlook will not be able to track the status of the tasks.

MindView exports your document to Microsoft Outlook as a series of tasks in the task folder you specified, and displays a message once the export is complete.

 You can exclude any branch from the export by disabling its 'Include in export' property in the Properties dialog.



### **Tasks with multiple resources**

One limitation of Outlook is that it is not able to track the status of tasks that are allocated to more than one person. For this reason, if some of your tasks are allocated to several resources, MindView displays a dialog asking you to choose how these tasks should be processed.



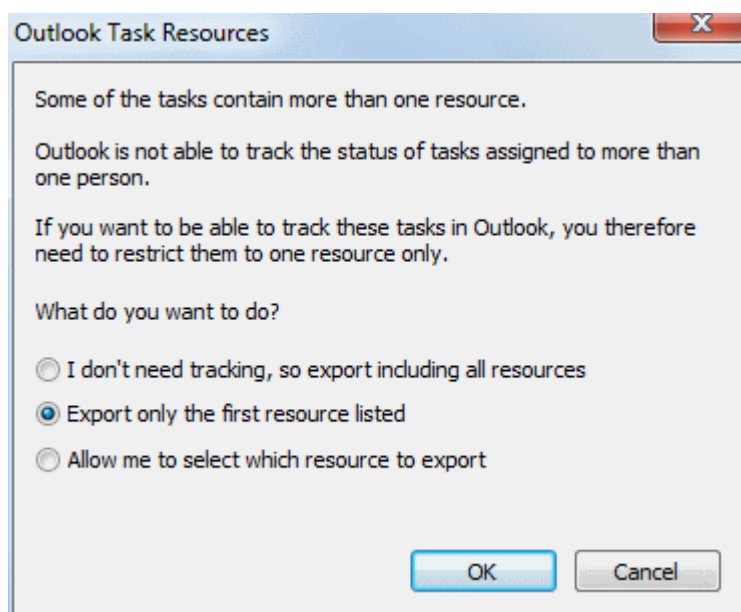

You have several choices:

- If you don't need to track the status of the tasks with Outlook, you can choose to export those tasks with all their resources anyway. All the resources will be listed in your Outlook task folder, but the tasks will not be sent to the resources themselves.
- When processing a task with multiple resources, you can get MindView to choose automatically the first resource listed for the task and send the task to that resource.
- You can also get MindView to let you choose which of the resources the task should be sent to. If you choose that option, MindView displays a further dialog listing all the tasks that have multiple resources, so that you can choose the resource to use in each case.

### Limitations

When a MindView branch contains sub-branches, only the sub-branches are exported. Parent branches are not exported.

Only the elements of the MindView document that are supported in Microsoft Outlook are exported:

- Task names (i.e. branch names), dates, durations, priority and completion values are exported in the Outlook task list.
- Pop-up comments are exported as Outlook task notes.
- Text notes are not exported.
- Other elements of the MindView document that are not supported by Microsoft Outlook (such as branch pictures, icons, attached objects and so on) are not exported.

### Synchronizing the MindView document and the Outlook task list

Once you have exported a MindView document to Microsoft Outlook, or conversely imported an Outlook task list into MindView, you can continue making changes to the tasks in MindView or in Outlook. You can even continue working on the task list in both applications independently. If at some point you want to re-align the two versions to make sure they contain identical data, you can use MindView's synchronization feature.

If you have made changes to your task list in MindView after having exported it to Outlook, you can export these latest changes to the Outlook version of the task list as follows:

- Click the **File** tab.
- Choose **Export | Microsoft Outlook | Synchronize Tasks**.

The **Synchronization from MindView to Microsoft Outlook** dialog opens.

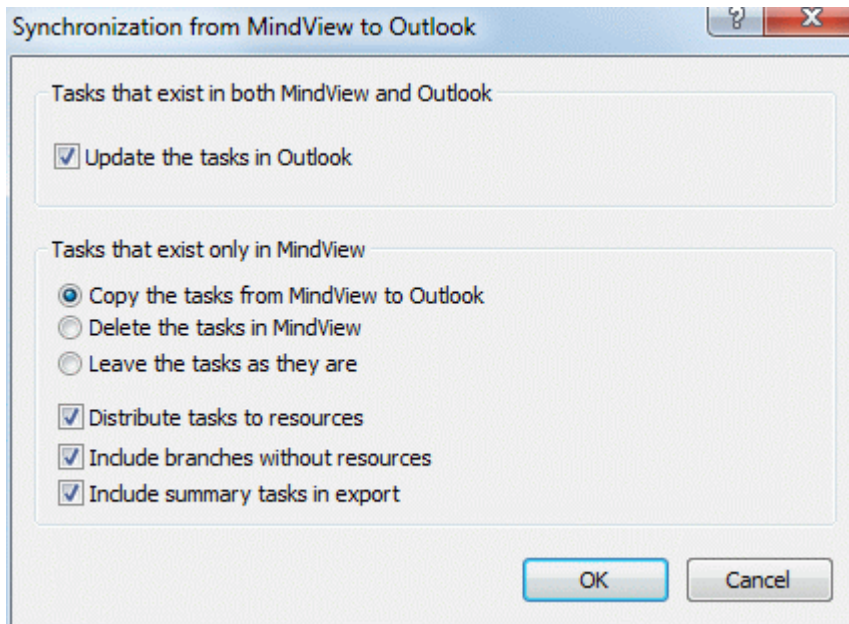

The top part of the dialog determines what will happen when the same task exists in both the MindView document and the Outlook task list in two different forms.

- To copy the task from the MindView document to the Outlook task list (thereby overwriting any other task information associated with the task in Outlook with the MindView version), check **Update the tasks in Outlook**.

The bottom part of the dialog lets you specify what should happen if a task present in the MindView document cannot be found in the Outlook task list. You have three choices:

- Copy the task from the MindView document to the Outlook task list
  - 🔗 If you choose this option, you have the same choices listed at the bottom of the dialog as when exporting a MindView document to Outlook as a set of new tasks. See above for a description of these options.
- Delete the task from the MindView document, so that it does not exist any longer in either version
- Leave things as they are

If conversely you have made changes to your task list in Outlook after having exported it from MindView, you can re-import these changes into your MindView document. For more information about this procedure, see "[Importing from Microsoft Outlook](#)".

## Exporting to Microsoft Project



MindView lets you export your document as a Microsoft® Project plan. This may be useful when, for instance, having built and fine-tuned a project plan in the MindView Gantt view, you now want to take advantage of Microsoft Project's advanced project management capabilities.

All the task and scheduling information contained in the MindView project plan is exported to Microsoft Project.



This export method is only available when you are working on a project plan. See "[Inserting task data](#)" and "[Using the Gantt view](#)" for more information about project plans.

MindView also lets you import documents from Microsoft Project. For more information, see "[Importing from Microsoft Project](#)".



MindView does not support versions of Microsoft Project prior to 2003. You need to have Microsoft Project installed on your computer in order to use this export method.

 You can also export a MindView project plan to the Microsoft Project XML format. The advantage of this method is that you do not need to have Microsoft Project installed on your machine. See "[Exporting to XML](#)" for more information.

## Procedure

- Click the **File** tab.
- Choose **Export | Microsoft Project**.
- Choose a file name and a destination for the exported file and click OK.

MindView starts exporting your document to Microsoft Project as a new project plan, and displays a message once the export is complete.

## Limitations

Only the elements of the MindView project plan that are supported by Microsoft Project are exported:

- Branch pictures, icons, attached objects and so on are not exported.
- Text notes are exported as Microsoft Project task notes.
- Pop-up comments are not exported.

 The property 'Include in export' of the Properties dialog is ignored when exporting to Microsoft Project.

## Exporting to HTML

### Overview



This export method lets you export your mind map as a set of web pages in HTML format. It allows you to obtain a professional-looking web site very quickly, without having to worry about web design techniques.



Although you do not need to have a web browser installed on your machine in order to use this export method, you obviously need one to view the web site created. Among the web browsers supported by the MindView HTML export are Internet Explorer version 6.0 or above and Firefox 3.0 and above.

The exported HTML pages are placed in a sub-folder named 'MVHtmlExport' in the folder of your choice.

All the pictures you have included in your document are placed in a sub-folder of 'MVHtmlExport' named 'img', whereas the picture files used by the MindView export template are placed in a sub-folder named 'mvfiles'. All other external files used in your document are placed directly in 'MVHtmlExport'. As it creates the HTML pages, MindView automatically modifies all the references to external files contained in your document so that they point to the correct output folder.

Each branch, including the root, is exported as a HTML page of the same name as the branch, and each page contains a menu of all its sub-branches and optionally, a menu of the main branches.

By default, a Home button taking you back to the root page is included on each HTML page. A Site Map button containing a link to an interactive picture of your entire map and a 'You are here' locator showing you the complete path from the root are also included on each HTML page.

Unless you define a different arrangement in the Export Wizard, all the objects attached to a branch are exported below each other and left aligned on the page.

The branches of the map are exported to HTML in the order in which they are displayed in the Mind Map view, starting from the top right in a clockwise direction.

You can however exclude entire branches and sub-branches from the export by disabling their 'Include in export' property in the Properties dialog.

Include in Export	<input checked="" type="checkbox"/>
-------------------	-------------------------------------

 If you are filtering the map to display only branches that meet specific criteria (see "[Filtering a mind map](#)"), only the branches visible on the workspace will be exported. To export the entire map, you need to go back to the full display by clearing the filter applied.

 If you want a specific description to appear when the user hovers a picture from your map in the browser, you can enter this description in the Name property of the relevant picture (root picture, branch picture, floating picture or attached picture file). This description is then converted by MindView to an HTML Alt tag during the export.

## Export modes

There are two export modes available:

- **Quick Export**



The [Quick Export](#) mode allows you to export your map quickly using the MindView defaults or the last export settings you chose.

- **Export Wizard**



The [HTML Export Wizard](#) lets you choose from a number of professional ready-made templates with various navigation layouts which you can customize to your liking. You can also specify the elements of your map to be exported and how they should be treated. Moreover, if you have created a particular folder structure for the external files used by your document, you can ensure that MindView preserves this structure when exporting to HTML by specifying the list of folders that need to be included in the export folder. Finally the Export Wizard lets you export you map as a SCORM (Sharable Content Object Reference Model) compatible package and specify its characteristics such as name, title, description, keywords and manifest identifier.

The export settings you choose are saved with the MindView document and re-used next time you export your map to HTML. This means that you do not have to redefine them every time you make a small alteration to your map.

## Relationship between MindView and HTML elements and objects

The following table indicates how the various MindView elements and objects are exported on the HTML page.

MindView element	Exported to HTML as
Branch name	Page title
Text note	Inserted as text
Branch picture	Inserted as picture
Floating picture	<ul style="list-style-type: none"> <li>● If connected to a branch, inserted as a picture</li> <li>● If not connected to a branch, not exported</li> </ul>
Floating comment	<ul style="list-style-type: none"> <li>● If connected to a branch, inserted as text</li> <li>● If not connected to a branch, not exported</li> </ul>
Pop-up comment	Inserted as text
Branch connection	Depending on your choice in the export dialog, inserted as a button link or as a hyperlink

MindView object	Exported to HTML as
Text file	Depending on your choice in the export dialog, inserted as a button link or as a hyperlink
Picture file	Inserted as a picture
Video file	Inserted as a Media Player object
Sound file	Depending on your choice in the export dialog, inserted as a button link or as a hyperlink
Hyperlink	Inserted as a hyperlink
Flash file	Inserted as a Flash file (embedded)

## Exporting to HTML: Quick Export

- Click the **File** tab.
- Choose **Export | HTML | Quick HTML Export**.
- If your MindView view contains several maps (i.e. several roots), choose the map you want to export in the 'Select Map to Export' dialog and click OK.

The **HTML Quick Export** dialog appears.

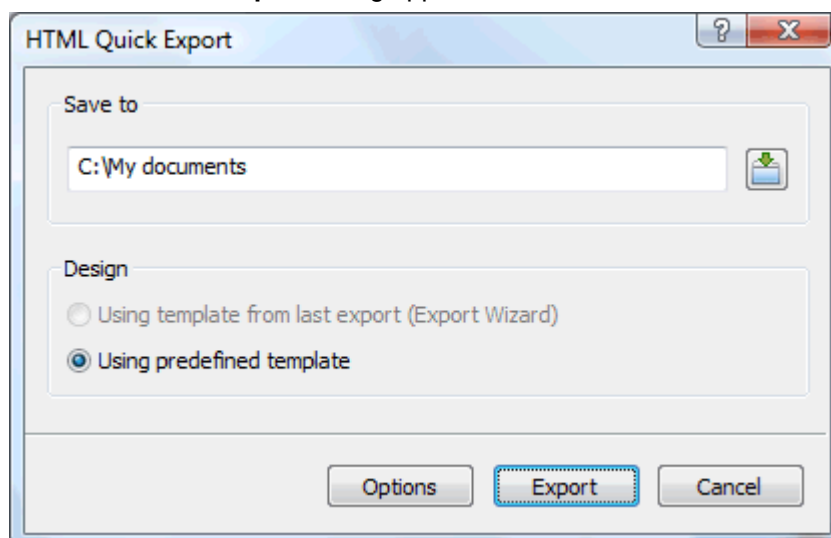

- Choose a path for your new web site.  
MindView will create a sub-folder named 'MVHtmlExport' in the folder you specify, and place all the files making up your web site in this sub-folder.
- Choose whether to use:
  - The template you last used in the Export Wizard if you have already used that export mode for your map.
  - The MatchWare predefined export template (with top and side navigation menu)
- (optional) Click **Options** to define further export options:  
The **Select Objects** tab allows you to specify the elements of the map to include in the export.

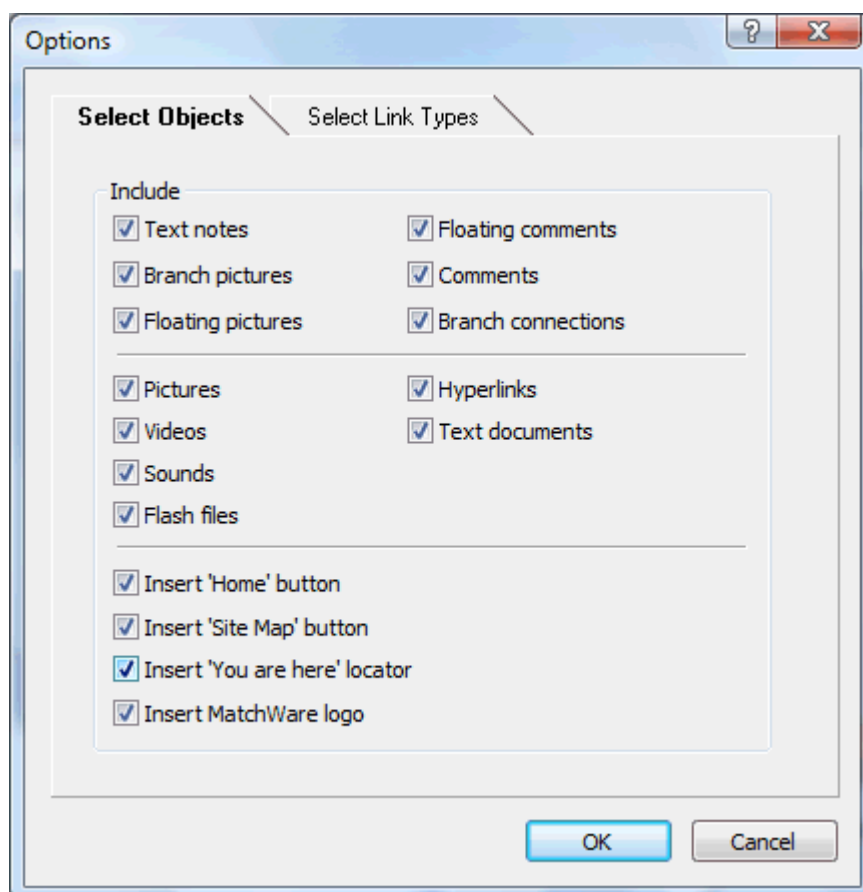

 If you exclude some elements from the export by deselecting them here, none of the elements of this type will be exported, regardless of the value of their individual 'Include in export' property in the Properties dialog. Let's suppose for instance your map contains a floating picture whose 'Include in export' property is enabled. If you choose to exclude floating pictures from the export here, your floating picture will not be exported. Conversely, if you specify here that floating pictures should be exported, only the floating pictures whose 'Include in export' property is enabled will be exported.

Include in Export

The **Select Link Types** tab only appears if your map contains branch connections and/or attached sound files or text files. It lets you choose whether these elements should be placed on HTML hyperlinks or buttons.

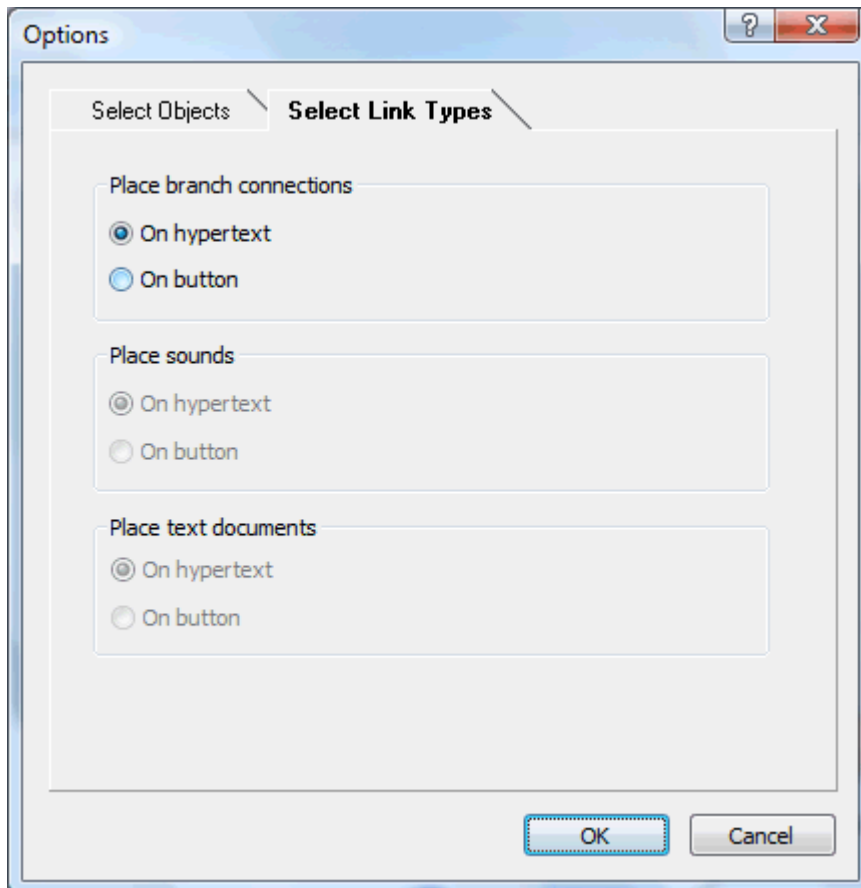

- Click **Export**.

Once the export is completed, MindView displays a dialog giving you the choice of immediately viewing your web site in your default browser or uploading it to Internet using the MatchWare FTP Upload Manager. For more information on this tool, see "[FTP Upload Manager](#)".



To open your exported web site from within Windows Explorer at a later date, double-click the file index.htm in the sub-folder 'MVHtmlExport'.

## Exporting to HTML: Export Wizard

- Click the **File** tab.
- Choose **Export | HTML | Advanced HTML Export**.
- If your MindView view contains several maps (i.e. several roots), choose the map you want to export in the 'Select Map to Export' dialog and click Next.

The Export Wizard now displays a series of dialogs, the first of which is the **Select Template** dialog.

### Selecting a template

This dialog allows you to select a navigation layout for the pages of your web site.



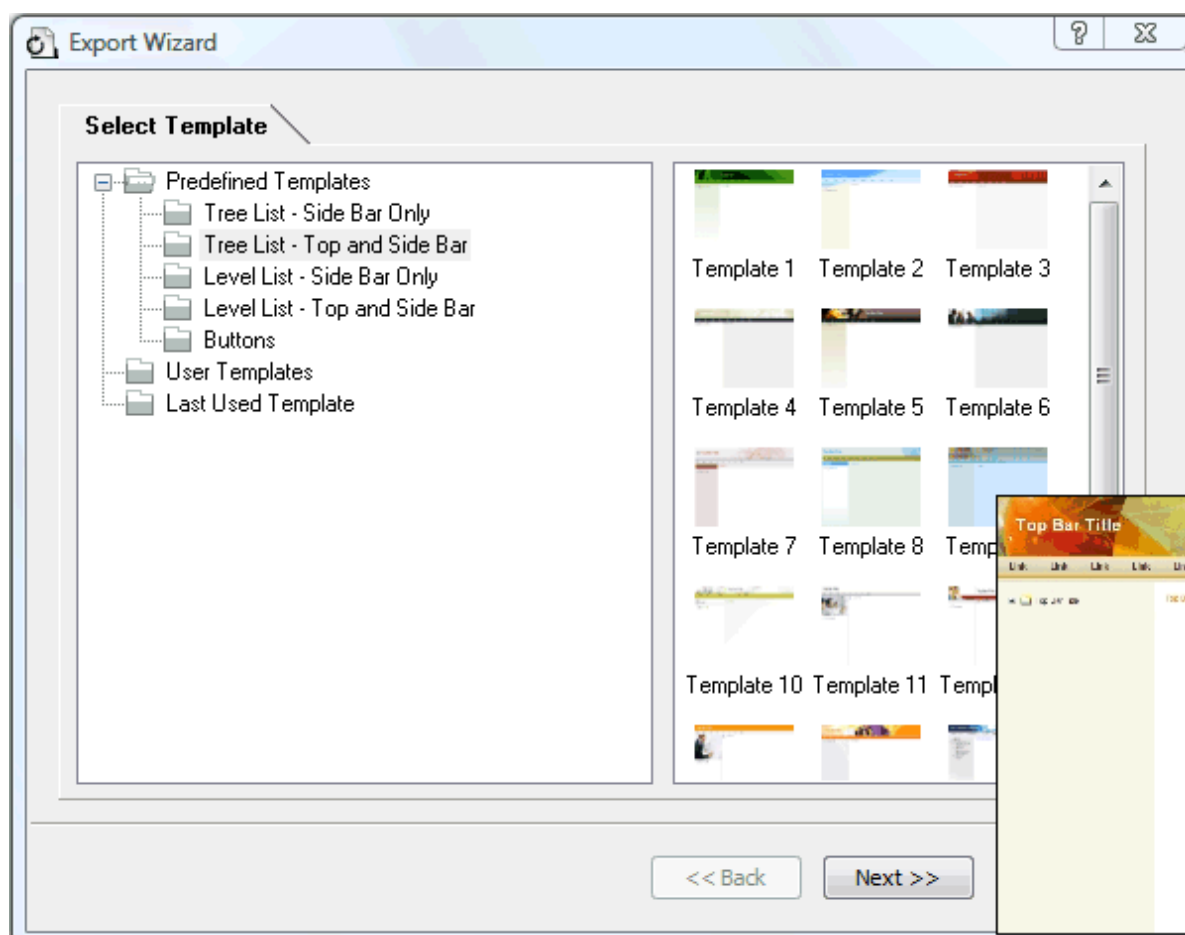

- **Predefined Templates:** This lets you choose one of the professional MindView export templates with ready-made top and side navigation.

These templates are available in the following navigation styles :

**Tree List:** With this design, the list of side links is shown as a tree whose levels you can expand and collapse as in Windows Explorer. All the pages of the web site are available from the Tree List.

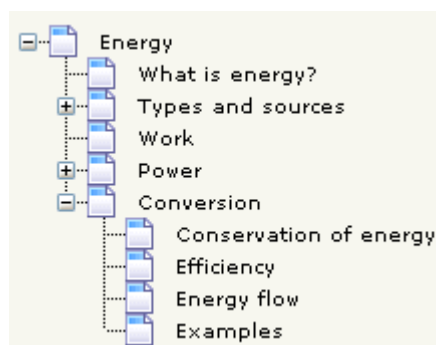

**Level List:** With this type of navigation, you only see a maximum of three levels of links on the side: the current page, any pages at the level just above it, and any pages at the level just below it.

<b>Home</b>
<b>What is energy?</b>
<b>Types and sources</b>
<b>Work</b>
<b>Power</b>
<b>Conversion</b>
Conservation of energy
Efficiency
Energy flow
Examples

**Buttons:** In this design, the side bar contains a list of links, where each link represents a sub-branch of the branch corresponding to the current page.

What is energy?	Types
Home	
Site Map	
Potential	
Kinetic	
Chemical	
Thermal	
Nuclear	
...other	

To see a larger preview of the templates shown on the right of the window, just place the mouse pointer over the relevant thumbnail. Note that you will be able to go back to this step of the wizard at any time to choose a different template if you are not satisfied with your original choice.

- **User Templates:** This lets you choose one of your own previously saved export templates. See further down for information on how to save your own export template.
- Select a template on the right and click Next.

## Preview

The Export Wizard opens the **Preview** dialog, which lets you customize the various areas of the navigation layout chosen in the first step.

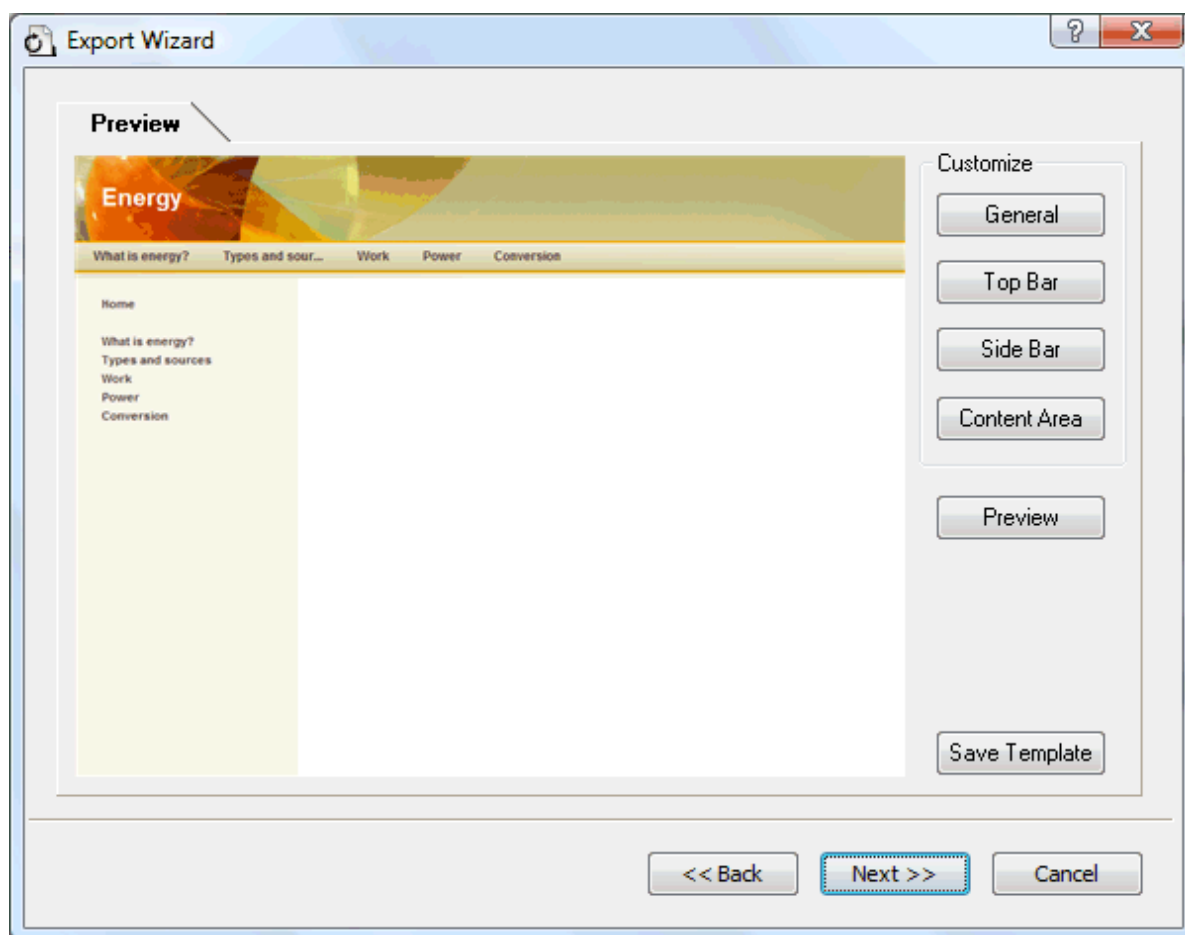

You can customize each area in turn by clicking the **Customize** buttons, namely:

- General
- Top Bar
- Side Bar
- Content Area

Feel free to experiment with the various customization options. At any time, you can obtain a full size preview of your design reflecting any changes made by clicking the Preview button. Note however that this Preview does not allow you to navigate the site.

#### ***Customizing the General properties (optional)***

- Click **General** in the Preview dialog.

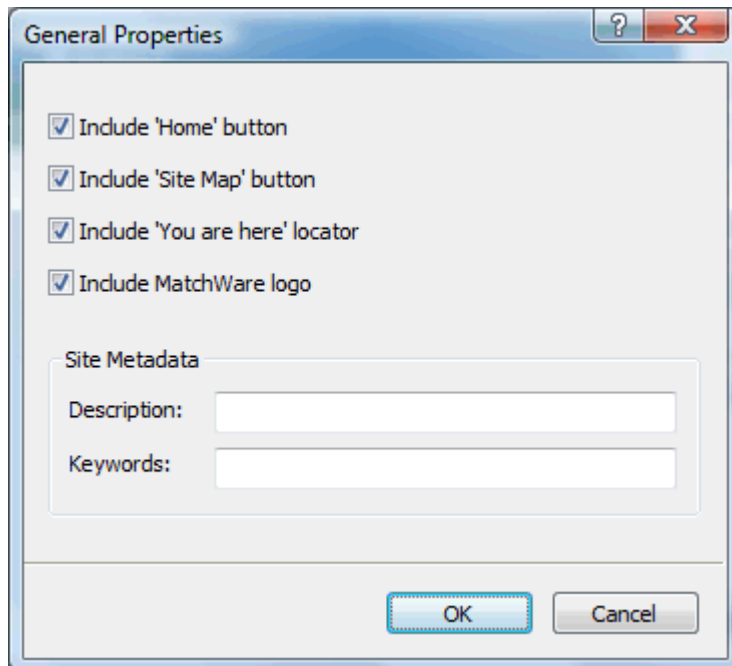

This dialog gives you the following options:

**Include 'Home' button:** This inserts a Home hyperlink or button on each of your web pages, allowing you to return to the page corresponding to the root of your map in just one click.

This option is not available if you have chosen a Tree List design, as this design always allows you to return to the root of your map in one click. A 'Home' button is therefore superfluous in this case.

**Include 'Site Map' button:** This inserts a Site Map hyperlink or button on each of your web pages. Clicking it will display an interactive picture of the entire web site.

**Include 'Timeline' button:** This option is only available if you are exporting a document from the Timeline view. It inserts a Timeline button on each of your web pages. Clicking it will display an interactive representation of the timeline as shown in the Timeline view. For more information about working with timelines, see "[Using the Timeline view](#)".

**Include 'You are here' locator:** This inserts a dynamic link on each page of the web site to show the complete path from the root web page to that particular page.

You can also enter meta-tags for your web site as follows:

**Description:** Any text entered here will be inserted in the <description> tag of each of the HTML pages created.

**Keywords:** Similarly, any keywords entered here (separated by commas) will be inserted in the <keywords> tag of each of the HTML pages created.

#### ***Customizing the Top Bar (optional)***

- Click the **Top Bar** button or double-click the top bar area in the Preview dialog.

The Top Bar Properties dialog opens on its **Title** tab.

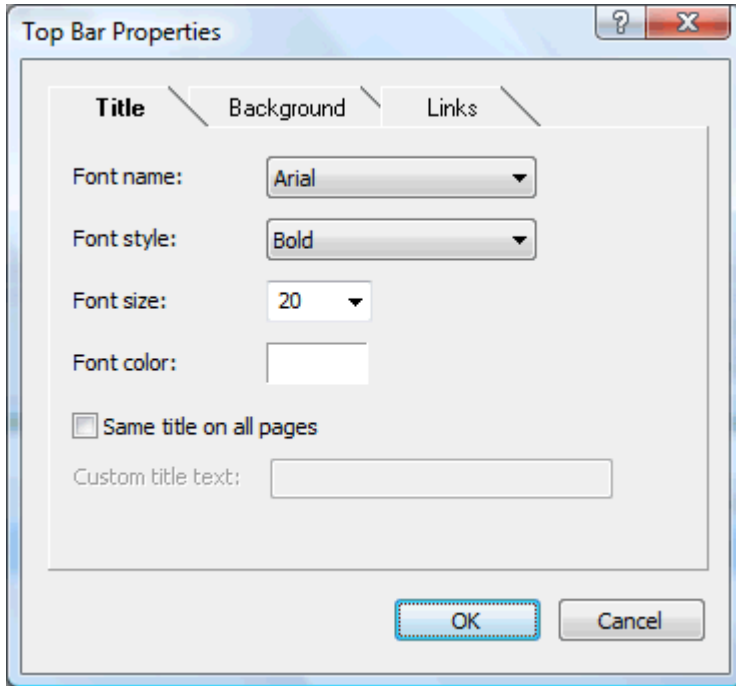

By default, the title displayed on each web page is the branch name. Here you can change the font, attributes and color for this title or even enter your own title, which will be displayed on all the pages of the web site.

- Click the **Background** tab.

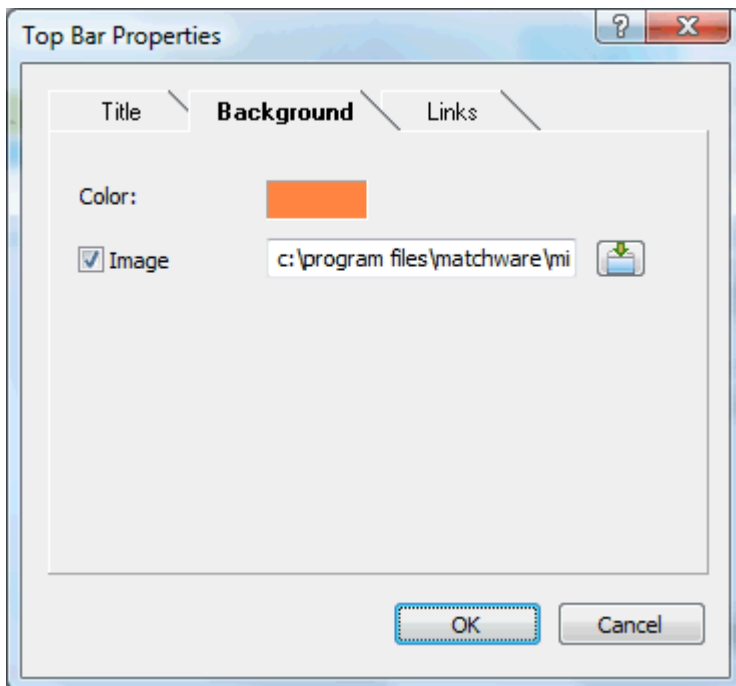

This tab lets you select a plain color or a different background picture for the top bar.

If you want to change the background picture, the best approach is to make a copy of the existing picture and edit its design to suit your requirements, making sure that the picture size stays unchanged so that it still fits the template.

- Click the **Links** tab.

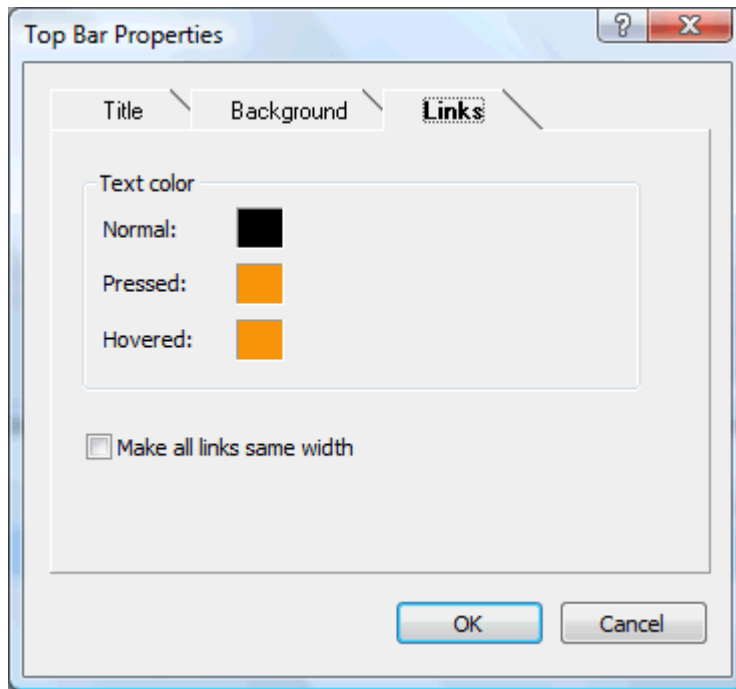

 The Links tab is only available if the top bar of the template chosen contains buttons or hyperlinks.

This tab lets you select different colors for the top bar links depending on their state, i.e. "Normal", "Pressed" (the link is clicked) or "Hovered" (the mouse pointer is placed on the link).

You can also choose to make all the links the same width, or have their width vary according to the length of their label.

#### **Customizing the Side Bar (optional)**

- Click the **Side Bar** button or double-click the side bar area in the Preview dialog.

The Side Bar Properties dialog opens on its **Background** tab.

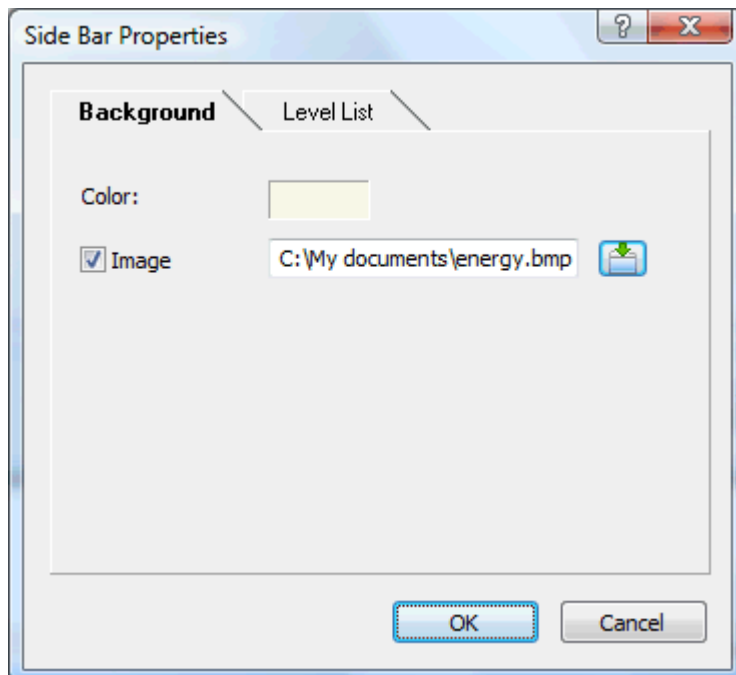

This tab lets you select a plain color or a different background picture for the side bar.

As for the top bar, the best approach if you want to change the background picture is to make a copy of the existing picture and edit its design to suit your requirements.

The second tab of the Side Bar Properties dialog varies depending on the type of navigation template you chose in the first screen of the Export Wizard. The three possibilities are:

- Tree list
- Level list
- Links

We will now look at each of these possibilities in turn.

### Tree List

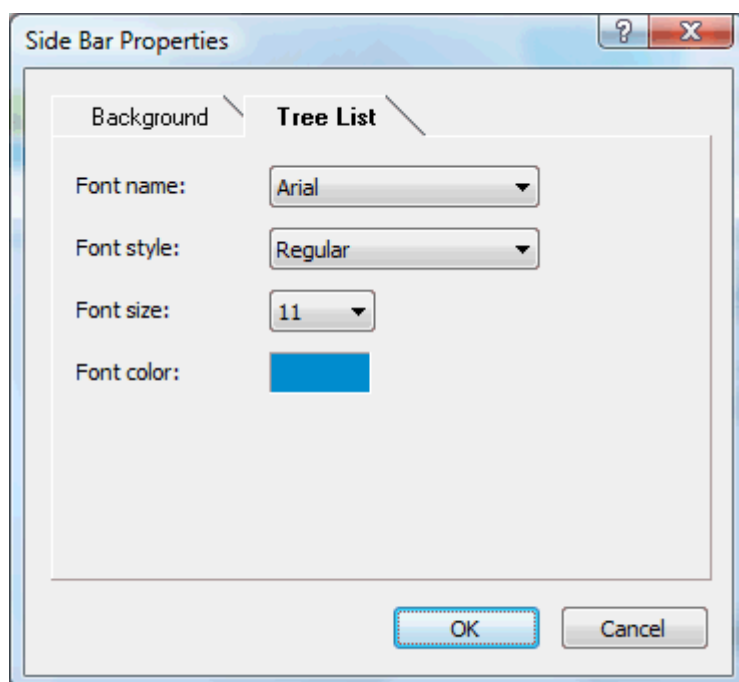

This is the tab displayed if you have chosen a Tree List design in the first step of the Export Wizard.

With this design, the list of side page links is shown as a tree whose levels you can expand and collapse as in Windows Explorer. All the pages of the web site are available from the Tree List.

This tab lets you modify the default font, attributes, size and color of the links.



## Level List

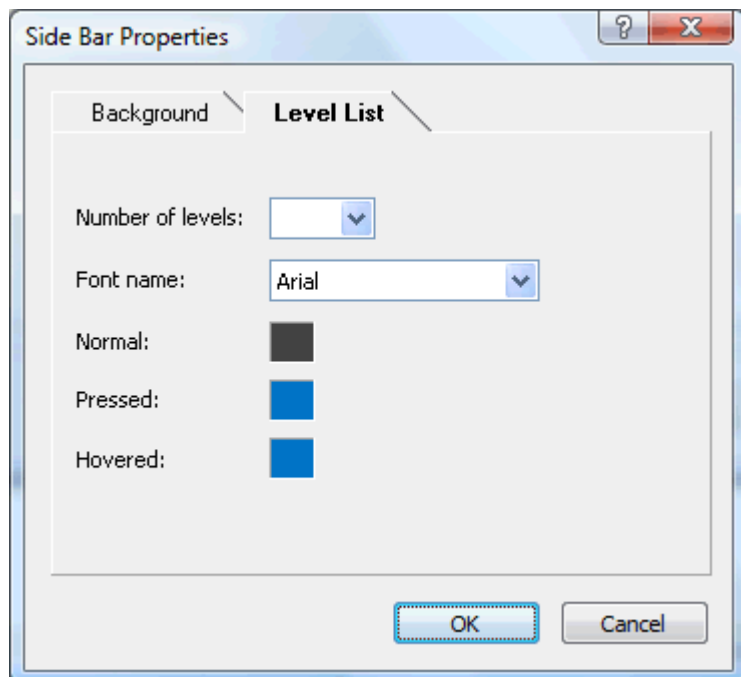

This tab is displayed if you have chosen a Level List design.

With this type of navigation, you only see a maximum of three levels of links on the side: the current page, any pages at the level just above it, and any pages at the level just below it.

The Level list tab lets you choose how many levels the list should show. You can also define the font and color of the links.

## Links

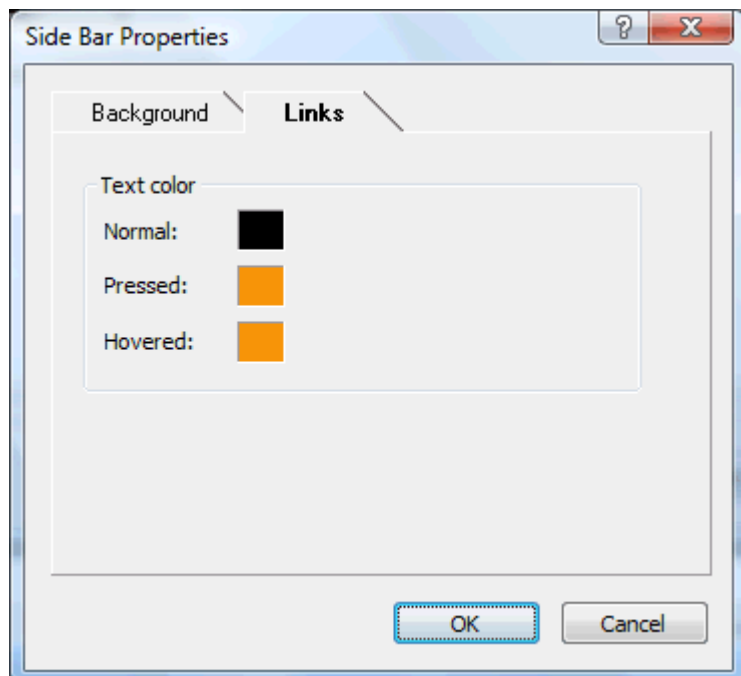

This tab is displayed if you have chosen a Buttons design in the first screen of the Export Wizard.

With this design, the side bar contains a list of links, where each link represents a sub-branch of the branch corresponding to the current page. The Links tab lets you select different colors for the side bar links depending on their state, i.e. "Normal", "Pressed" (the link is clicked) or "Hovered" (the mouse pointer is placed on the link).

### Customizing the Content Area (optional)

- Click the **Content Area** button or double-click the middle area in the Preview dialog. The Content Area properties dialog opens on its **Background** tab.

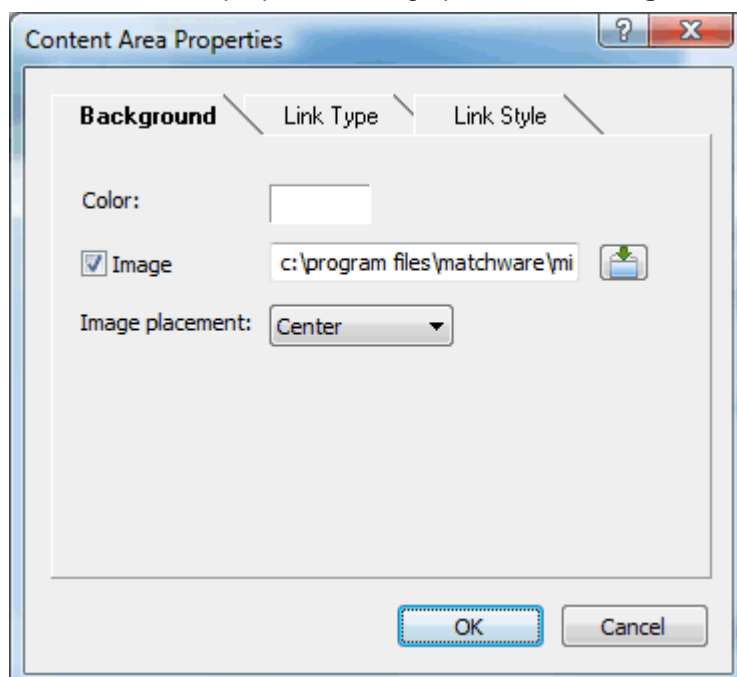

This tab lets you select a plain color or a different background picture for the body of the page. Feel free to experiment with the image placement options by checking the effect in the Full Size Preview.

- Click the **Link Type** tab.

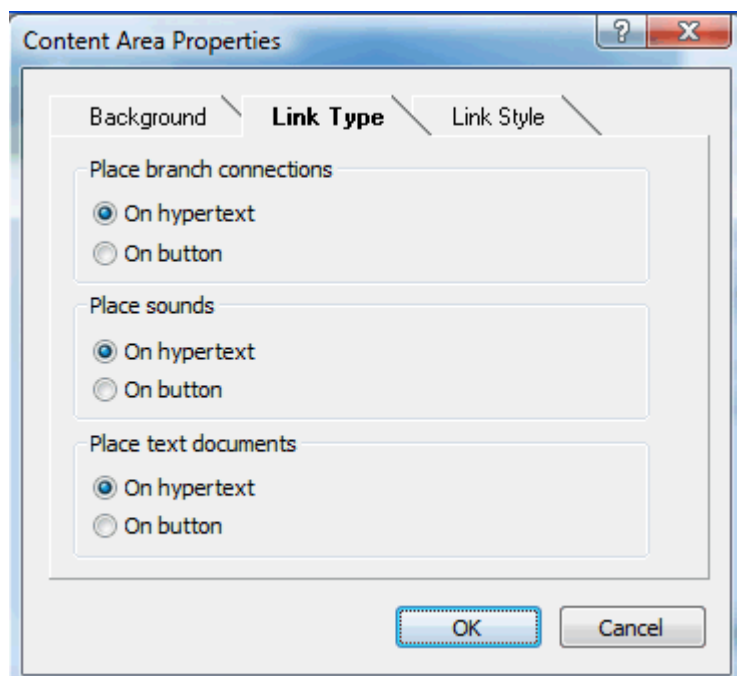

If your map contains branch connections, sound files or attached text documents, this tab lets you decide whether you want to place these objects on hyperlinks or on buttons.

- Click the **Link Style** tab.

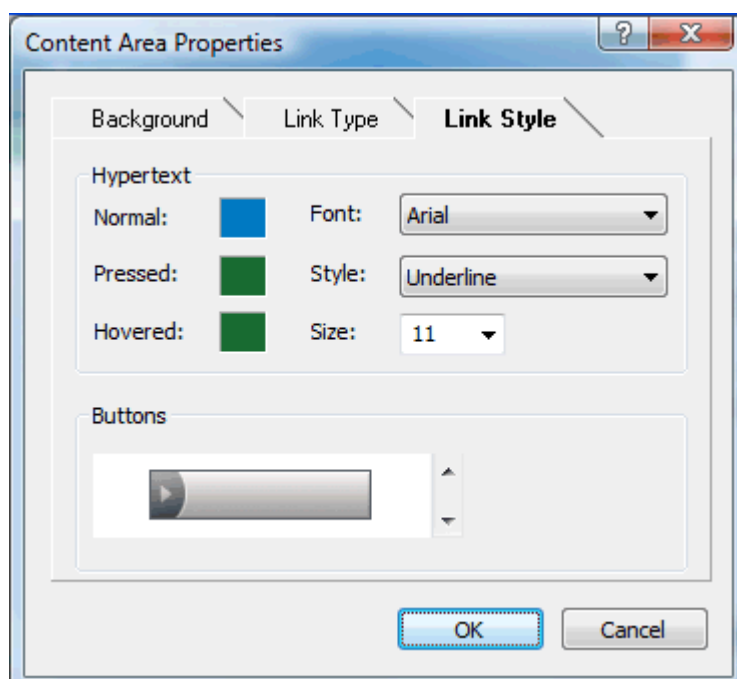

This tab lets you choose styles for any buttons or hyperlinks created on your web pages.

- Define the hyperlink style required by selecting a font, attribute and size. You can also define different colors depending on the state of the hyperlink, i.e. "Normal", "Pressed" (the link is clicked) or "Hovered" (the mouse pointer is placed on the link).
- Scroll through the various buttons available to choose the type you like best.

#### ***Previewing the customized template (optional)***

- Click the **Preview** button in the Preview dialog to obtain a 800x600 real-time preview of your design reflecting any changes made so far.
- Check how your web site will look in different browser resolutions by resizing the window. Reducing the window size might for instance cause the top buttons or hyperlinks to spread onto two rows. Conversely enlarging the window might cause them to arrange themselves on one row only.

#### ***Saving the customized template (optional)***

- You can save your customized export template for later use by clicking the **Save Template** button of the Preview dialog. The Save User Template dialog that opens contains a list of the export templates you have already saved. Enter the name of your new export template and click Save.
- Once you are satisfied with the design of all the page components, click Next.

#### **Selecting the objects to export**

The Export Wizard now opens the **Select Objects to Export** dialog.

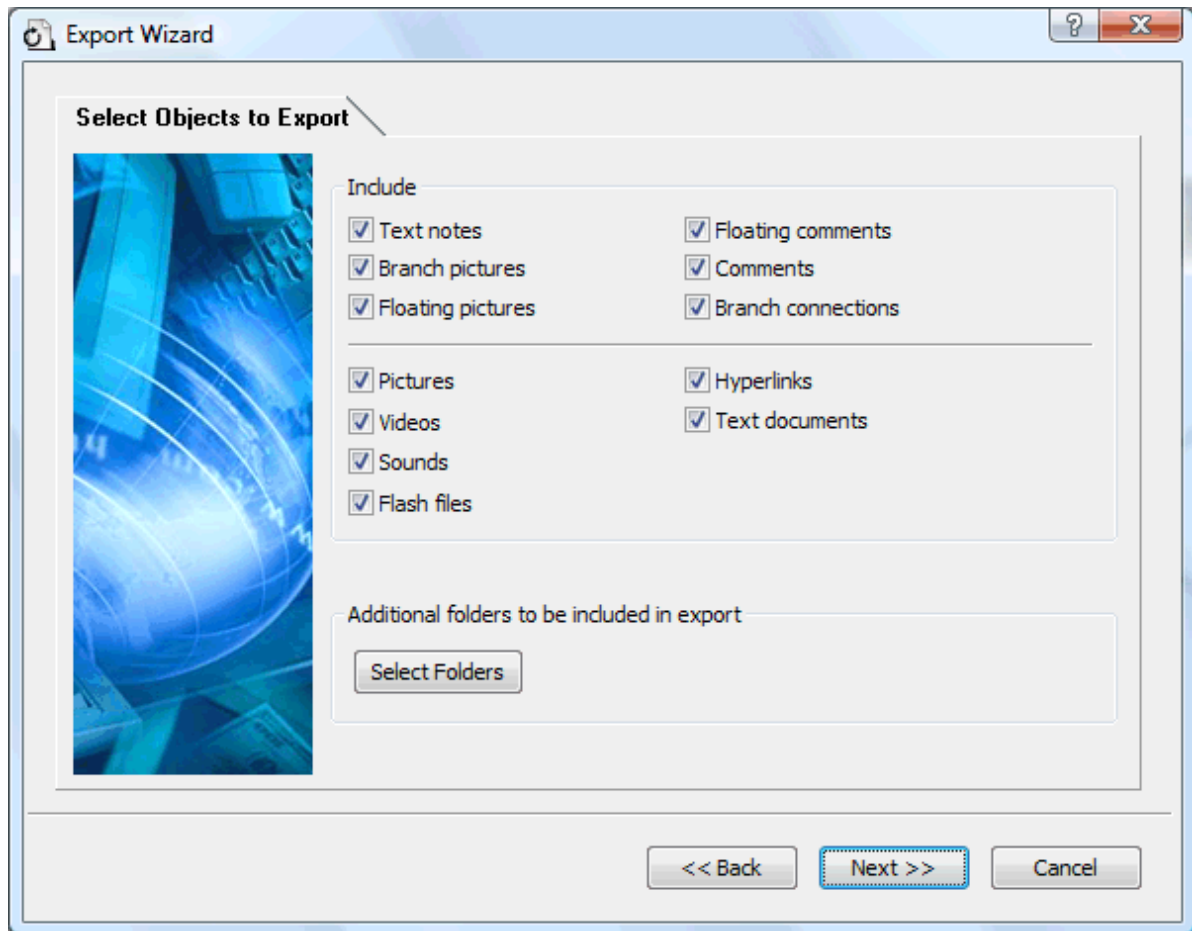

- Select the MindView objects which you want to export to HTML.

 If you exclude some elements from the export by deselecting them here, none of the elements of this type will be exported, regardless of the value of their individual 'Include in export' property in the Properties dialog. Let's suppose for instance your map contains a floating picture whose 'Include in export' property is enabled. If you choose to exclude floating pictures from the export here, your floating picture will not be exported. Conversely, if you specify here that floating pictures should be exported, only the floating pictures whose 'Include in export' property is enabled will be exported.

Include in Export	<input checked="" type="checkbox"/>
-------------------	-------------------------------------

If you have created a particular folder structure for the external files used by your document, you can ensure that MindView preserves this structure when exporting to HTML by specifying the list of folders that need to be included in the export folder as follows:

- Click the **Select Folders** button to open the following dialog:

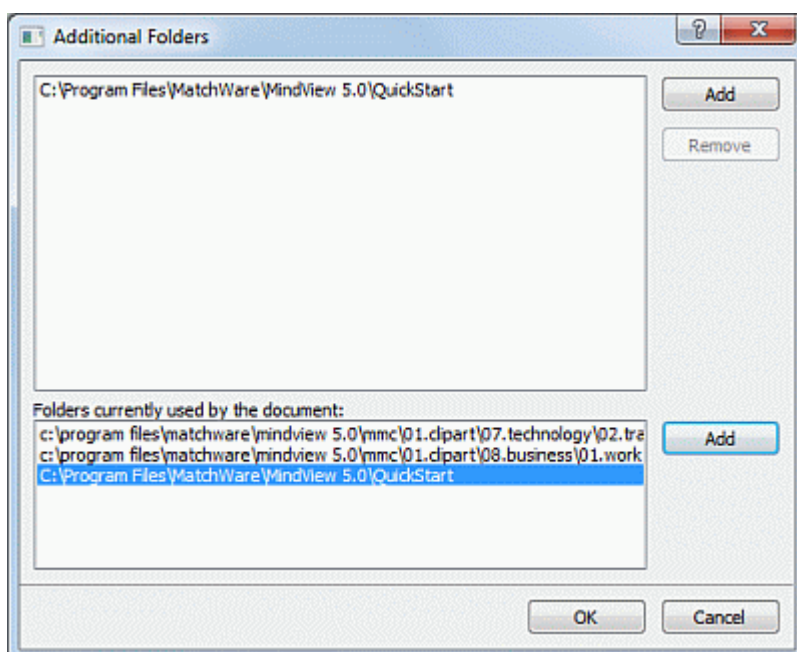

- Click the **Add** button and select the first folder you wish to include in the export.
- Repeat for all the folders you would like to include.

Note that you can enlarge the dialog by dragging one of its corners if the folder paths are not fully visible.

As it creates the HTML pages, MindView automatically modifies all the references to external files contained in your document so that they point to the correct output folder.

- Click Next.

### Placing the objects on the page

The Export Wizard now opens the **Select Placement** dialog, which allows you to define where the various objects attached to each branch should be placed on the corresponding HTML page.

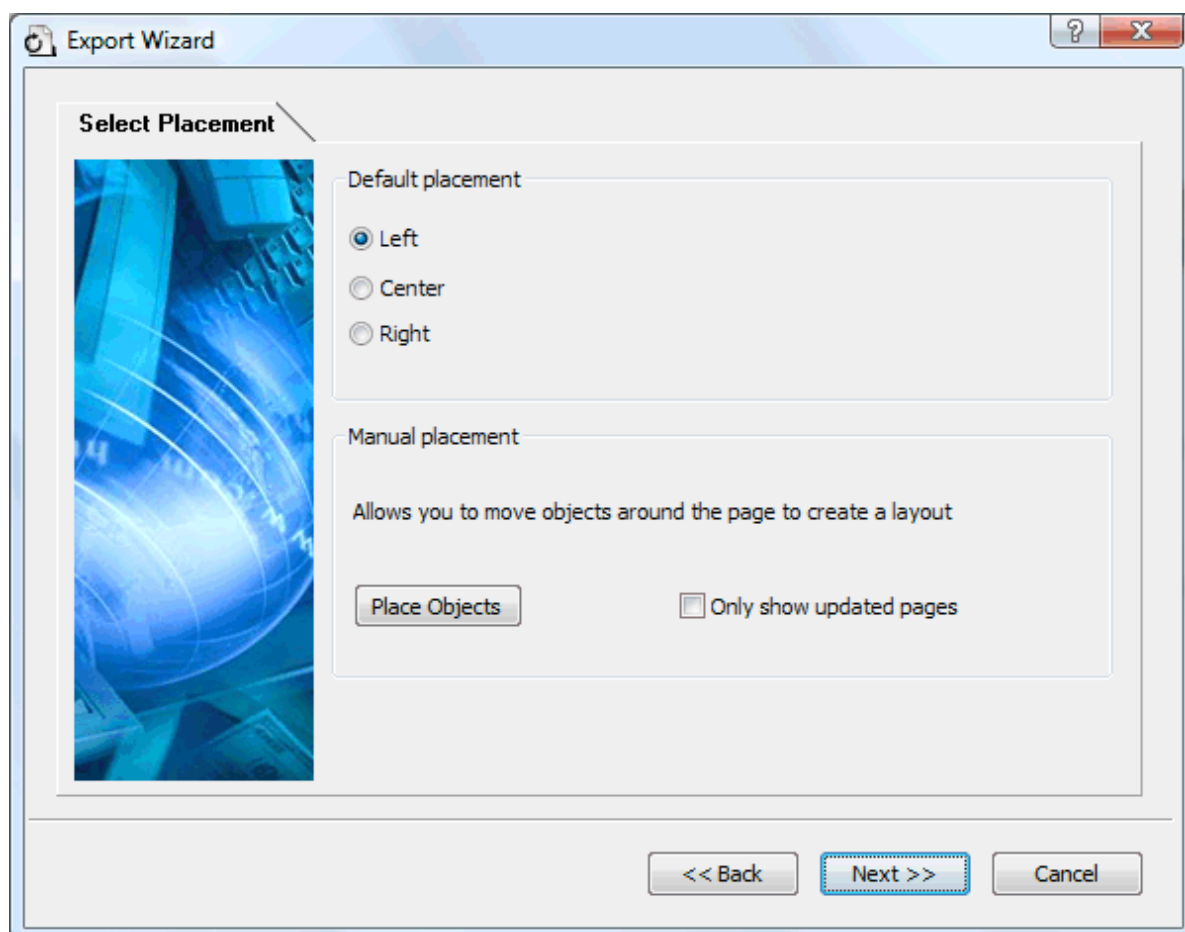

You can either:

- Choose a default placement of Left, Center or Right and click Next. In that case, the objects will be placed one after the other on each page according to their order in the Object list, either on the left, the center or the right of the page.
- Choose a default placement, and then click the **Place Objects** button to arrange the objects manually on the page as you wish.

 If you have already exported your map to HTML, you can check **Only show updated pages**. In that case, the Export Wizard only shows you the pages which you have edited since the last export. If your map contains a large number of branches, this saves time as you do not have to review the object positioning on all the unchanged pages.

#### ***Positioning the objects manually (optional)***

If you have chosen to place the objects manually by clicking 'Place Objects' in the previous dialog, the Export Wizard now shows the Object Positioning window.

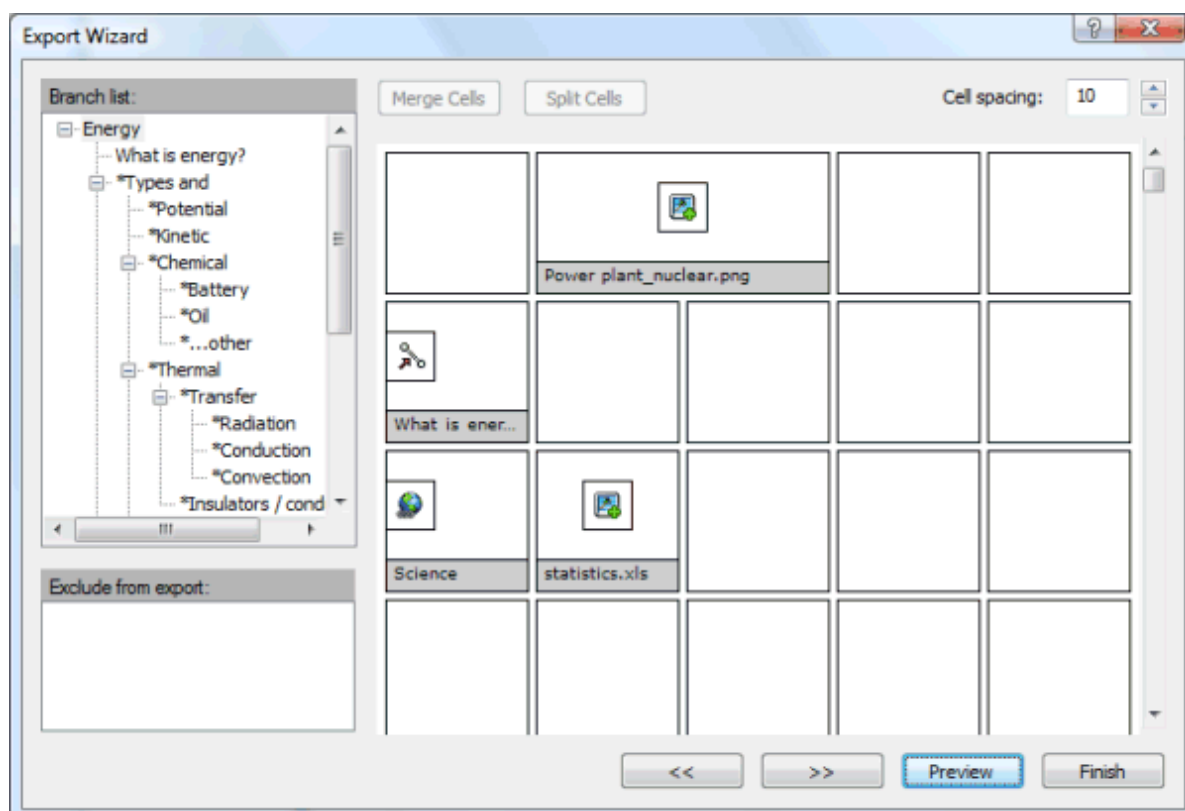

This is based on a default grid containing 5 columns, each representing 20% of the width of the HTML page, and divided in a number of cells.

All the objects associated with the first branch of your map are identified on the grid by a small icon bearing their name, in the default position chosen in the previous dialog. You can now reposition these objects or resize them by manipulating the grid cells as follows:

- To move an object on the page, drag it from one cell to the other.
- To resize a column on the grid, drag its edge until it reaches the required size.
- To merge two or more cells so that the object is stretched across them, select the cells by dragging the mouse pointer across them and click the **Merge Cells** button (or right-click and choose Merge Cells in its local menu).
- To split a cell made up of merged cells, select it and click **Split Cells** (or right-click it and choose Split Cells in the local menu).
- To align objects horizontally or vertically within a cell, select the relevant cells by dragging the mouse pointer across them, right-click and choose **Alignment** in the local menu. Then select an Alignment option by clicking a square in the menu (these represent top left alignment, top center alignment, top right alignment and so on). Note that you can also perform this operation on empty cells before moving objects into them.
- To add an empty row, right-click the row above which you want to insert a row and choose **Add Row** in its local menu.
- To delete a row, right-click it and choose **Delete Row** in its local menu.
- To increase or decrease the space between each cell, click the up or down arrows of the 'Cell spacing' option.

All the objects that are excluded from the export, either because you have disabled their 'Include in export' property or because you have chosen to exclude them in the 'Select Objects to Export' dialog described above, are listed in the 'Exclude from export' area in the bottom left of the grid. You are free to drag any of these objects back onto the HTML page.

You can also exclude particular objects from the export by dragging them to the 'Exclude from export' area, and drag them back to the HTML page later if you change your mind.

- Click **Preview** to visualize the effect of your changes on the actual page.



- When you are satisfied with the positioning of the objects on the page, click the right double arrow button to go to the next page, or choose another page in the Branch list shown on the left of the dialog.
- Repeat the operation until you have reviewed all the pages that needed revisiting.
- Once you have reviewed all the pages, click **Finish**.

## Exporting

You are now ready to export your map to HTML.

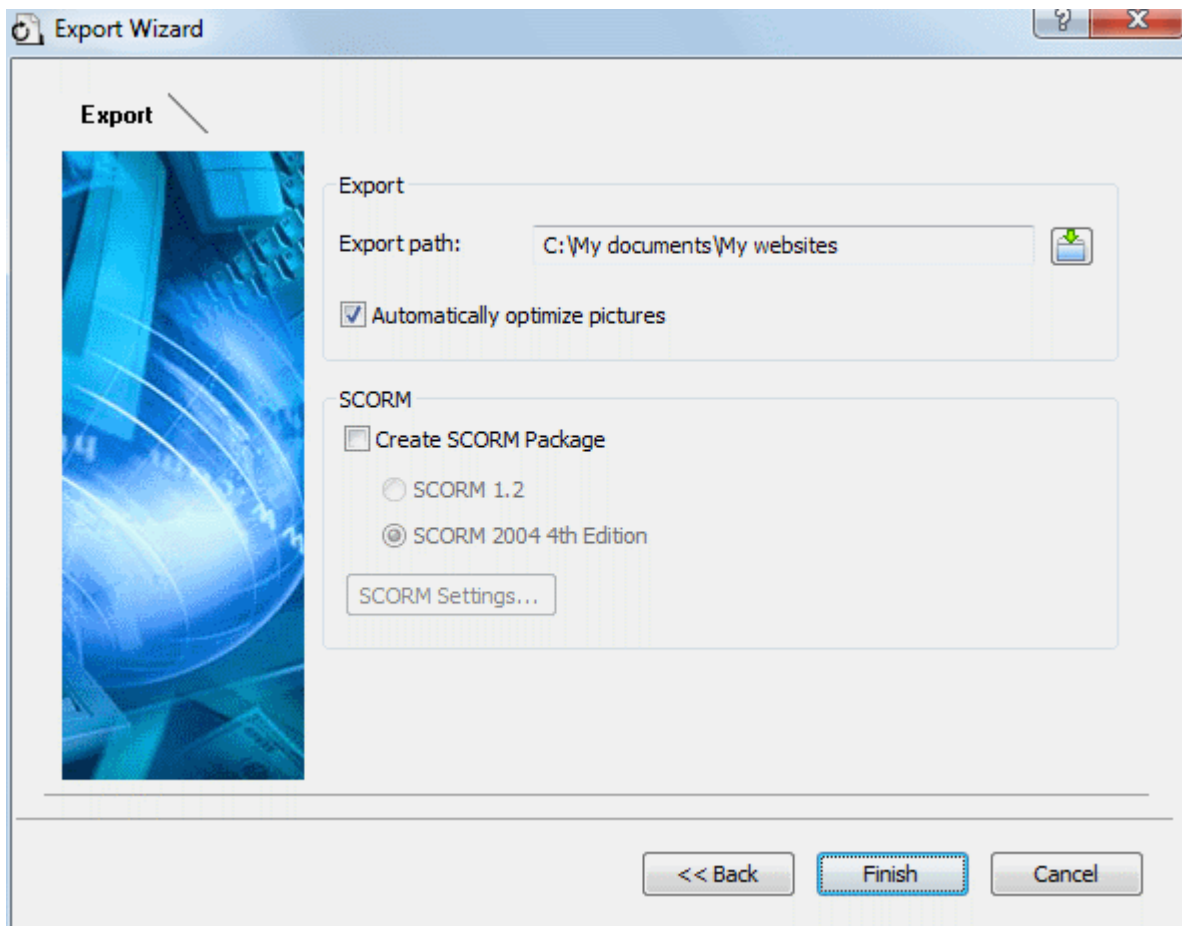

- Choose a destination folder for your new web site.
- (optional) You can optimize your pictures for web export by checking the option **Automatically optimize pictures**. This has two effects:
  - All .bmp pictures used on your map are converted to .jpg to reduce their file size.
  - Any .bmp or .jpg picture used on your map that is larger than the dimensions allocated to it on the HTML page is scaled down to these dimensions.
- (optional) To export the map as a SCORM package, check **Create SCORM Package** and select the relevant SCORM version.
- (optional) Click **SCORM Settings**.  
The **SCORM Manifest Settings** dialog opens to let you specify additional information about the package.

The SCORM Manifest file is automatically created by MindView. Among other things, it includes details about the package that enable students and teachers to search for specific learning content with the use of keywords.

**Catalog name:** This specifies the name of the Learning Management System (LMS) group or category of courses (e.g. Maths, Physics, Chemistry, etc.) in which the SCORM package should be placed.

**Course title:** This specifies the name used to identify the course within the LMS.

**Course description:** This is used to provide a description of the course, and its intended use.

**Comma separated keywords:** This field can be used to enter keywords (which must be separated by commas) which the students and teachers will be able to use to locate the package once it is deployed on the LMS.

**Manifest identifier:** This compulsory ID uniquely identifies the package among all the other packages deployed on the LMS.

The output of the export will be a zip file containing all the HTML content and other SCORM related helper files. This package can then be uploaded to the LMS (which must be SCORM 1.2 or SCORM 2004 compliant). How the package is placed on the LMS depends on the specific LMS, but generally it is done by a teacher using the web-based interface of the LMS. Please refer to the documentation of the LMS in question for information about this.

➤ **Click Finish.**

Once the export is completed, MindView displays a dialog giving you the choice of immediately viewing your web site in your default browser or uploading it to Internet using the MatchWare FTP Upload Manager. For more information on this tool, see "[FTP Upload Manager](#)".



To open your exported web site from within Windows Explorer at a later date, double-click the file index.htm in the sub-folder 'MVHtmlExport'.

## FTP Upload Manager

To help you get your HTML site on the web as quickly and effortlessly as possible, MindView comes with a built-in FTP program, the MatchWare FTP Upload Manager.

### Starting the FTP Upload Manager

Before you can use the FTP Upload Manager you must export your MindView document to HTML (see "[Exporting to HTML: Quick Export](#)" or "[Exporting to HTML: Export Wizard](#)"). At the end of the export the following dialog appears:

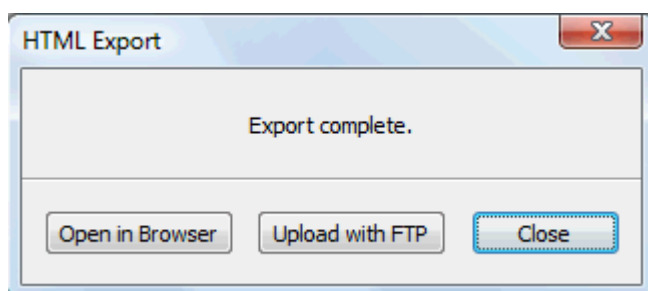

- To open the FTP Upload Manager click **Upload with FTP**.

The FTP **Upload Manager** dialog appears.

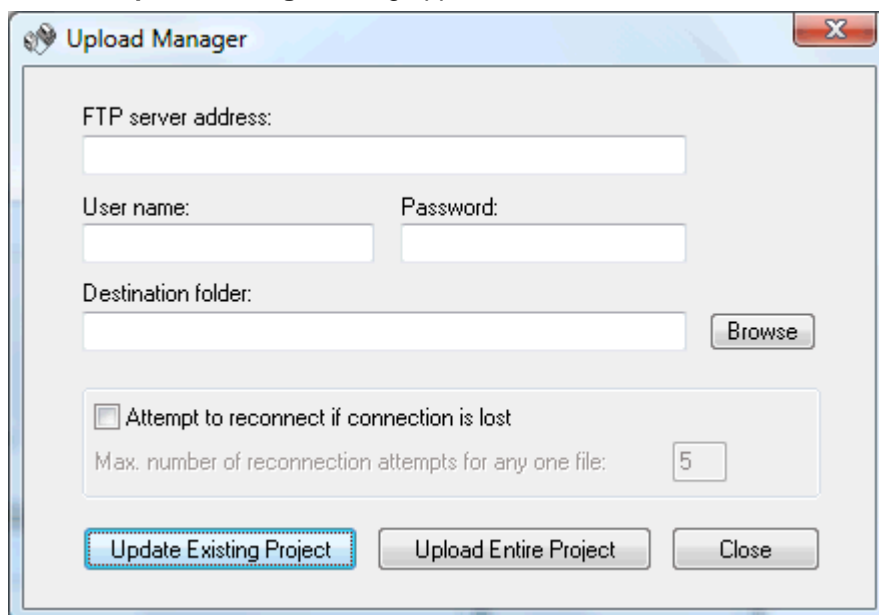

- In the **FTP server address** field, enter the FTP upload address that you have received from your Internet Service Provider (ISP).
- Enter your **User name** and **Password** in their respective fields.

 *If you do not have an FTP address, user name or password or have lost them, contact your ISP.*

- Clicking the Browse button next to **Destination folder** will connect you to the Internet. Once online, search for the remote folder you wish to upload your web site to.

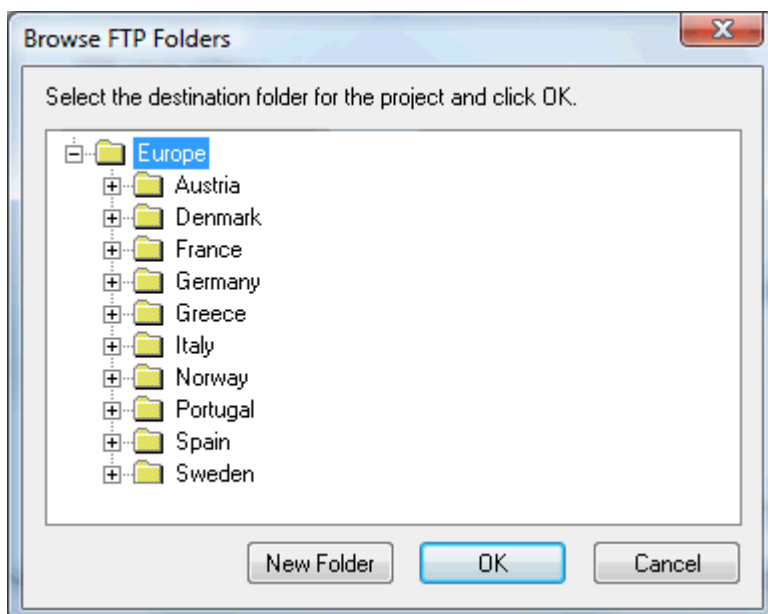

- Select the folder required and click OK to return to the Upload Manager dialog.  
If you would like to upload the web site to a new folder, click New Folder to create a new remote folder on the server. Click OK to return to the Upload Manager dialog.

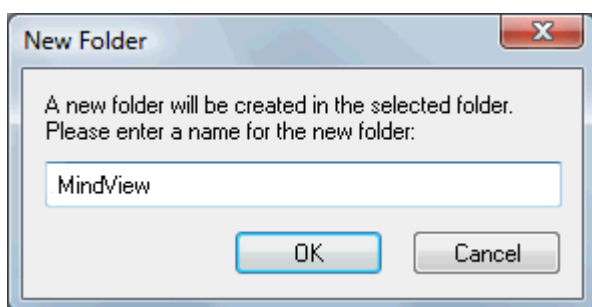

To quickly create a new remote folder enter a forward slash and the name of the new folder in the Destination folder field.

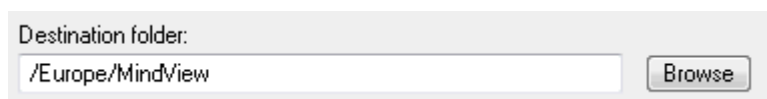

If your Internet connection goes down often, you are advised to check the option **Attempt to reconnect** in the Upload Manager dialog to guarantee a successful upload.

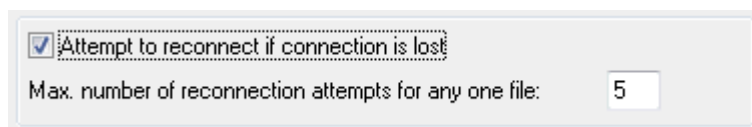

You can also set the number of reconnection attempts you want the Upload Manager to perform for a given file. If upload is still unsuccessful after this number of attempts, it is cancelled.

### Uploading your web site

- If you are uploading your web site for the first time, click **Upload entire project** to connect to the FTP server and upload all the files.

You can follow the progress of the upload in the Upload dialog.

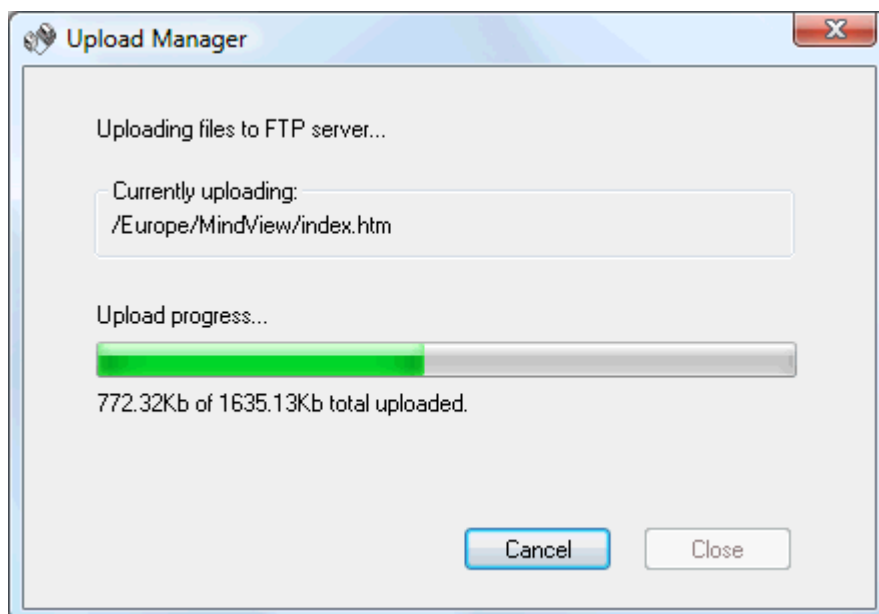

If upload is completed successfully, the following dialog appears:

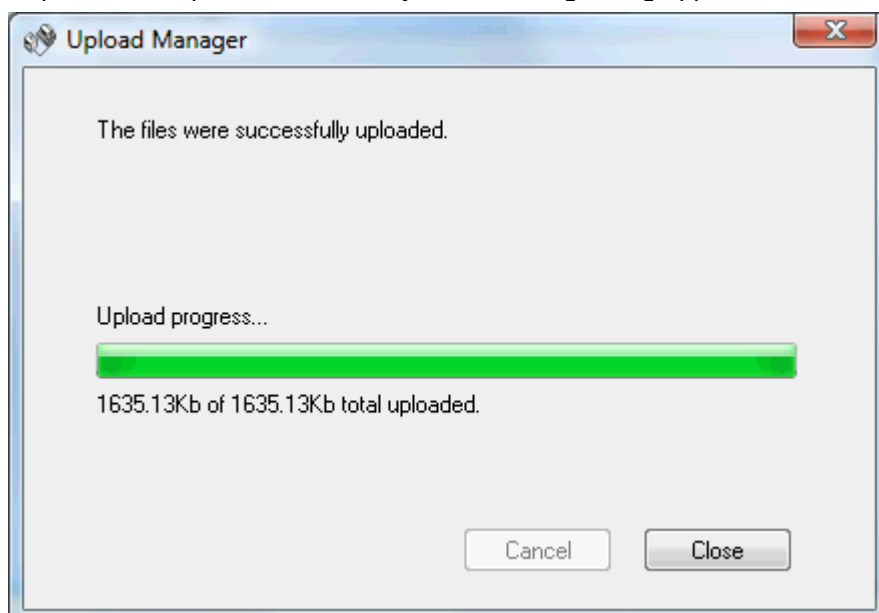

- Click **Close** to return to MindView.

The FTP Upload Manager remembers your FTP address, Username, Password and Destination. If you make changes to your web site and would like to upload it again, click **Update existing project** to upload only the files that have changed since your last upload.

## Exporting to PDF



This export method lets you export your mind map in PDF format.

It works in exactly the same way as the Microsoft Word export method. For more information, see "[Exporting to Microsoft Word](#)".

## Exporting to Mediator

### Overview



This export method lets you export your mind map as a Mediator document.

Combining MindView and Mediator is a powerful way to create web sites and multimedia presentations. Once you have finished brainstorming and organizing your ideas in MindView, you can export your map to Mediator and turn it into an interactive CD presentation or a set of dynamic Flash or HTML pages by adding Mediator events and actions to it.

If after working for some time on your Mediator presentation, you realize you need to review the structure of your map in MindView before doing any further work in Mediator, you can re-import it back into MindView without losing the work already done in Mediator. See "[Importing from Mediator](#)" for more information.



You do not need to have Mediator installed on your computer to use this export mode. However, you will need Mediator 9 or above to open the exported Mediator document.

The exported Mediator document is placed in the folder of your choice, and all relevant external files are placed in a sub-folder named MD8 within that folder.

Each branch, including the root, is exported as a Mediator page of the same name as the branch. The sub-branches belonging to a particular branch are exported as sub-pages of the corresponding Mediator page.

By default, a Home button, taking you back to the root page, and a Back button, taking you back to the previous page, are included in all the pages of your Mediator document.

All the objects attached to a particular branch are listed in the Mediator Object list of the corresponding Mediator page and tiled on the page on top of each other.

The branches of the map are exported to Mediator in the order in which they are displayed in the Mind Map view, starting from the top right in a clockwise direction.

You can however exclude entire branches and sub-branches from the export by disabling their 'Include in export' property in the Properties dialog.



*If you are filtering the map to display only branches that meet specific criteria (see "[Filtering a mind map](#)"), only the branches visible on the workspace will be exported. To export the entire map, you need to go back to the full display by clearing the filter applied.*



If your MindView document was created by importing a Mediator presentation, a dialog might appear at the end of the export procedure, listing all the branches corresponding to pages created directly in Mediator. Because you might not want to change the appearance of these pages in the new Mediator presentation, you can deselect them in this dialog to indicate that the export template should not be applied to them.



*When exporting the mind map to Mediator, MindView places special tags formatted with # signs in the Notes tab of the Properties dialog of particular elements of the new Mediator presentation, including the pages themselves. These tags contain information required by MindView to re-import the Mediator presentation, should you decide to do so at a later stage. You should take care not to delete these tags if you want to preserve the structure and layout of the original mind map.*

### Export modes

There are two export modes available:

- **Quick Export**



The [Quick Export](#) mode allows you to export your map quickly using the MindView defaults or the last export settings you chose.

- **Export Wizard**



The [Mediator Export Wizard](#) lets you choose from a number of professional ready-made templates with various navigation layouts which you can customize as you wish. You can also specify the elements of your map to be exported and how they should be treated.

The export settings you choose are saved with the MindView document and re-used next time you export your map to Mediator. This means that you do not have to redefine them every time you make a small alteration to your map.

### Relationship between MindView and Mediator elements and objects

The following table indicates how the various MindView elements and objects are exported on the Mediator page.

MindView element	Exported to Mediator as
Branch name	Page description. If the branch name is unique, the branch name is also the page name. Otherwise, page names are numbered sequentially, i.e. Idea, Idea01, Idea02 and so on.
Text note	Mediator text object Note that if the MindView text note contains one or more hyperlinks, these hyperlinks retain their color and underline attributes in the Mediator text object, but are not converted to Mediator hypertext objects. This means that they do not retain their link information.
Branch picture	Mediator picture object
Floating picture	<ul style="list-style-type: none"> <li>● If connected to a branch, inserted as a Mediator picture object on the page</li> <li>● If not connected to a branch, not exported</li> </ul>
Floating comment	<ul style="list-style-type: none"> <li>● If connected to a branch, inserted as a Mediator text object on the page</li> <li>● If not connected to a branch, not exported</li> </ul>
Pop-up comment	Text note in the Notes tab of the Properties dialog for the page
Branch connection	Mediator button, looking either like a standard button or a hypertext link, depending on your choice in the export dialog
MindView object	Exported to Mediator as
Text file	Mediator button, looking either like a standard button or a hypertext link, depending on your choice in the export dialog
Picture file	Mediator picture object
Video file	Mediator Media Player object
Sound file	Mediator button, looking either like a standard button or a hypertext link, depending on your choice in the export dialog
Hyperlink	Mediator button looking like a hypertext link
Flash file	Mediator Flash object

### Exporting to Mediator: Quick Export

- Click the **File** tab.
- Choose **Export | MatchWare Mediator | Quick Mediator Export**.



- If your MindView view contains several maps (i.e. several roots), choose the map you want to export in the 'Select Map to Export' dialog and click OK.

The **MatchWare Mediator Quick Export** dialog appears.

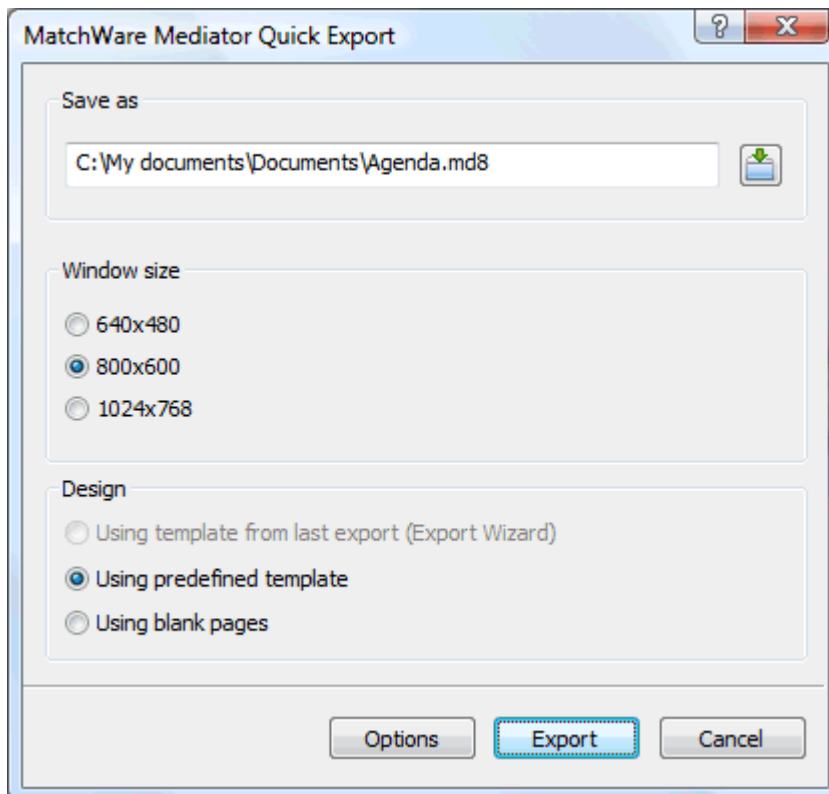

- Choose a path and file name for your new Mediator document.
- Choose the window size that corresponds to your screen resolution or the screen resolution of the intended users of your Mediator document.
- Choose whether to use:
  - The template you last used in the Export Wizard if you have already used that export mode for your map. If you choose this option, the window size options become inactive as the window size is already defined.
  - The MatchWare predefined export template (with top and side menu)
  - Blank pages (without any menu structure or graphic design elements)
- (optional) Click **Options** to define further export options:

The **Select Objects** tab allows you to specify the elements of the map to include in the export. You can also disable 'Insert Home button' and/or 'Insert Back button' if you do not want these buttons on the pages of your Mediator document.

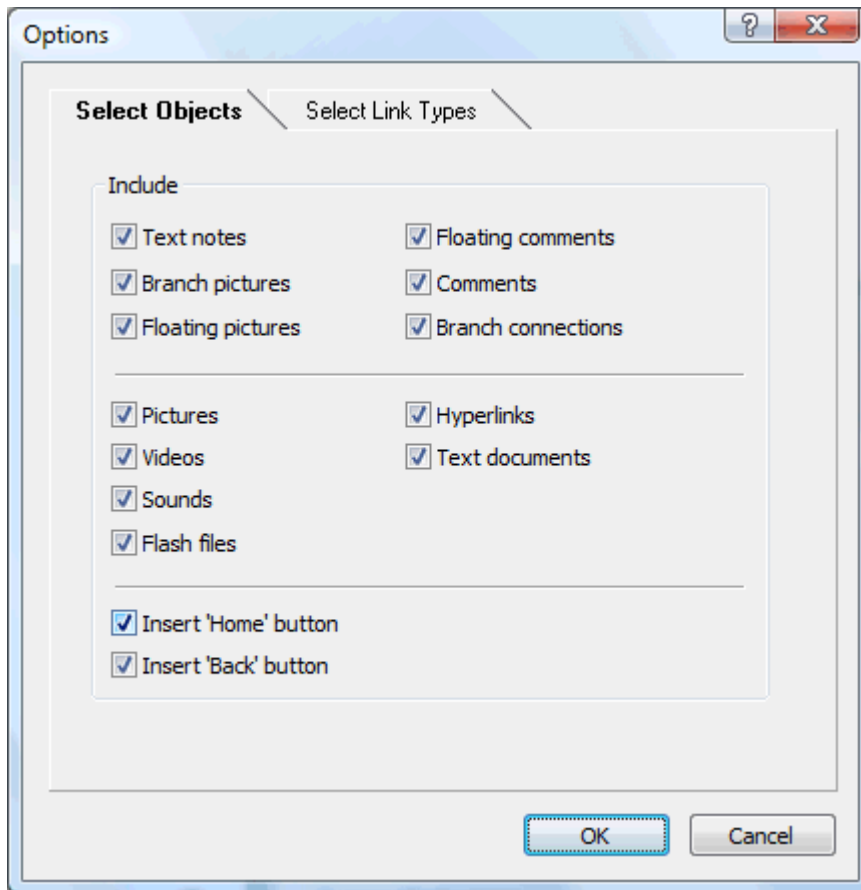

 If you exclude some elements from the export by deselecting them here, none of the elements of this type will be exported, regardless of the value of their individual 'Include in export' property in the Properties dialog. Let's suppose for instance your map contains a floating picture whose 'Include in export' property is enabled. If you choose to exclude floating pictures from the export here, your floating picture will not be exported. Conversely, if you specify here that floating pictures should be exported, only the floating pictures whose 'Include in export' property is enabled will be exported.

Include in Export

The **Select Link Types** tab only appears if your map contains branch connections and/or attached sound files or text files. It lets you choose whether these elements should be placed on Mediator hypertext or button objects.

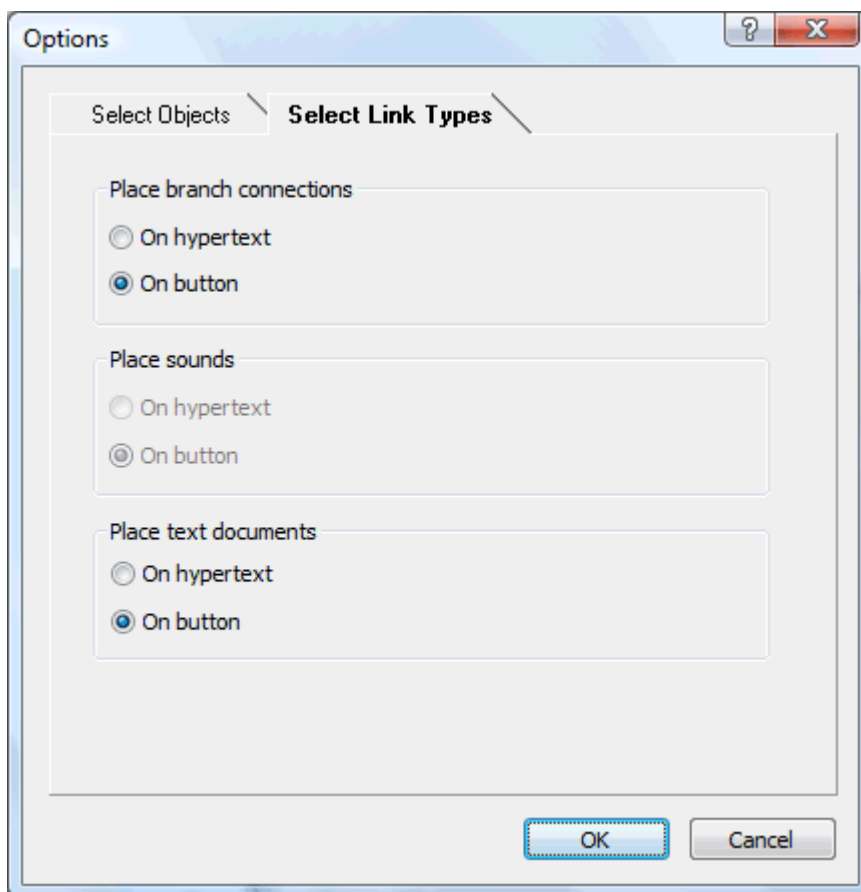

- Click **Export**.



If your MindView document was created by importing a Mediator presentation, a dialog might appear at this point, listing all the branches corresponding to pages created directly in Mediator. Because you might not want to change the appearance of these pages in the new Mediator presentation, you can deselect them in this dialog to indicate that the export template should not be applied to them.

Once the export is completed, MindView lets you either view your presentation straight away in Mediator or continue working in MindView.



*When exporting the mind map to Mediator, MindView places special tags formatted with # signs in the Notes tab of the Properties dialog of particular elements of the new Mediator presentation, including the pages themselves. These tags contain information required by MindView to re-import the Mediator presentation, should you decide to do so at a later stage. You should take care not to delete these tags if you want to preserve the structure and layout of the original mind map.*

## Exporting to Mediator: Export Wizard

- Click the **File** tab.
- Choose **Export | MatchWare Mediator | Advanced Mediator Export**.
- If your MindView view contains several maps (i.e. several roots), choose the map you want to export in the 'Select Map to Export' dialog and click Next.

The Export Wizard now displays a series of dialogs, the first of which is the **Select Window Size** dialog.

## Selecting the window size

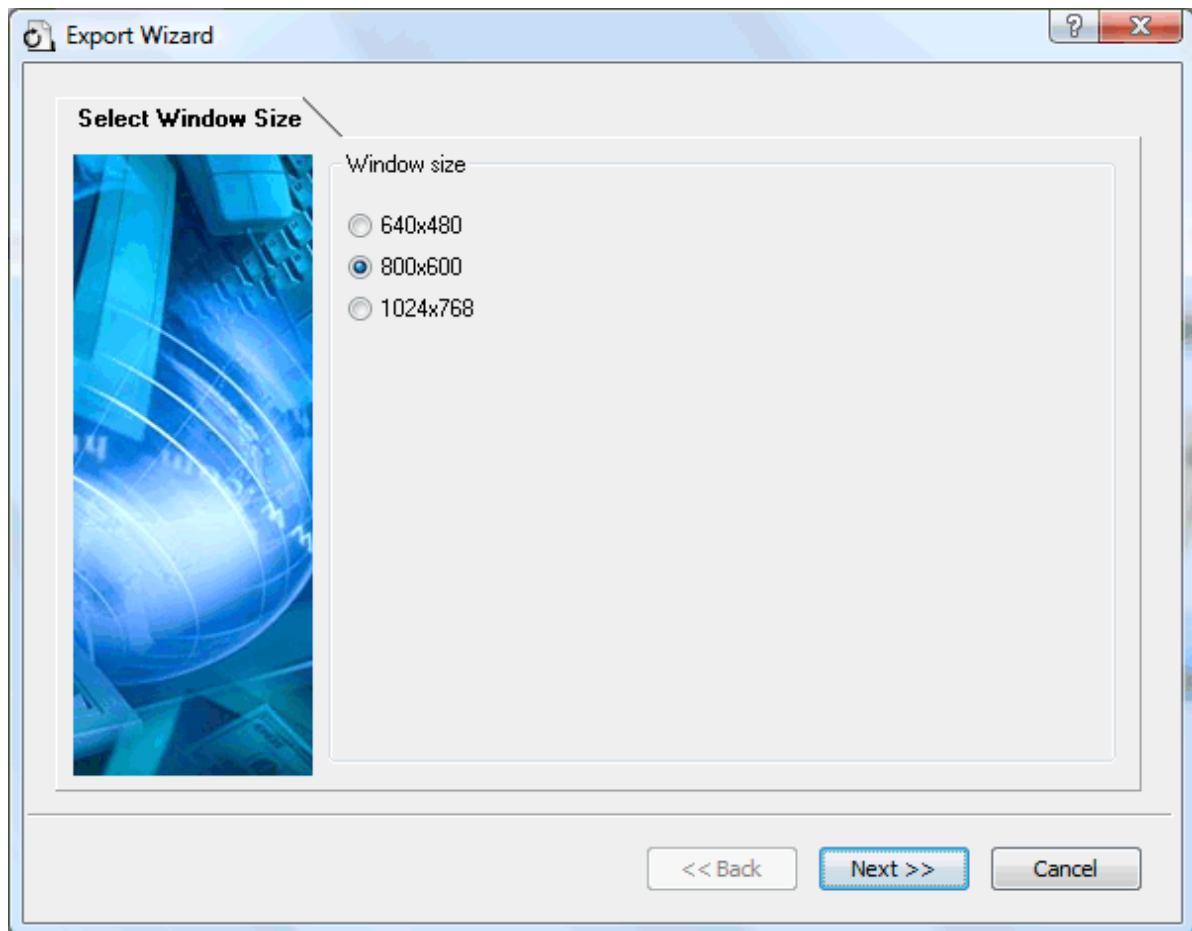

- Choose the window size corresponding to your screen resolution or the screen resolution of the intended users of your Mediator document and click Next.

## Selecting a template

This dialog allows you to select a navigation layout for the pages of your Mediator document.

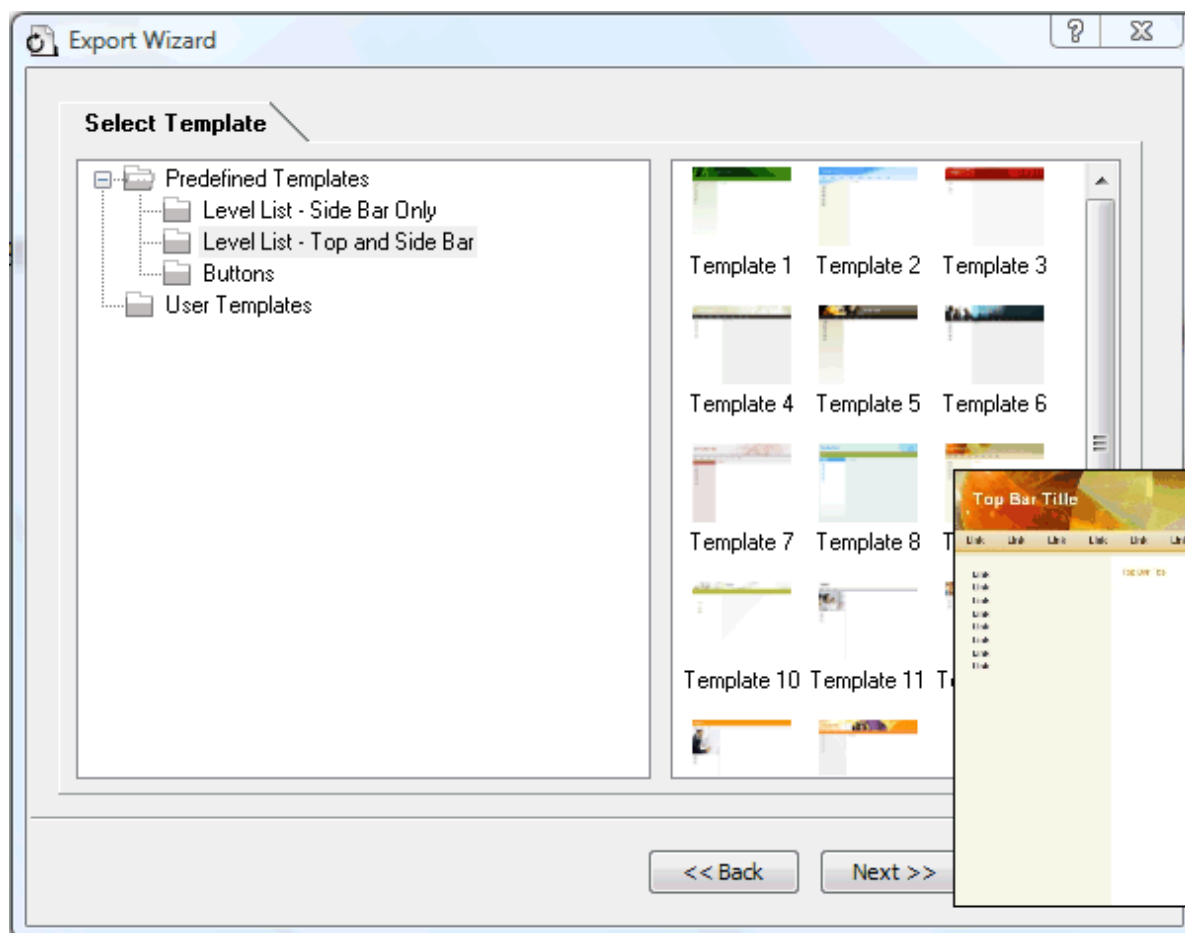

- **Predefined Templates:** This lets you choose one of the professional MindView export templates with ready-made top and side navigation.

These templates are available in the following navigation styles:

**Level List:** With this type of navigation, you only see a maximum of three levels of links on the side: the current page, any pages at the level just above it, and any pages at the level just below it.

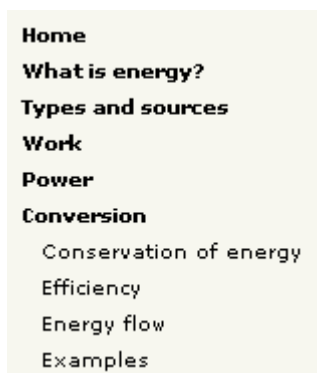

**Buttons:** In this design, the side bar contains a list of links, where each link represents a sub-branch of the branch corresponding to the current page.

What is energy?	Types
Home	
Site Map	
Potential	
Kinetic	
Chemical	
Thermal	
Nuclear	
...other	

To see a larger preview of the templates shown on the right of the window, just place the mouse pointer over the relevant thumbnail. Note that you will be able to go back to this step of the wizard at any time to choose a different template if you are not satisfied with your original choice.

- **User Templates:** This lets you choose one of your own previously saved export templates. See further down for information on how to save your own export template.
- Select a template on the right and click Next.

### Preview

The Export Wizard opens the **Preview** dialog, which lets you customize the various areas of the navigation layout chosen in the first step.

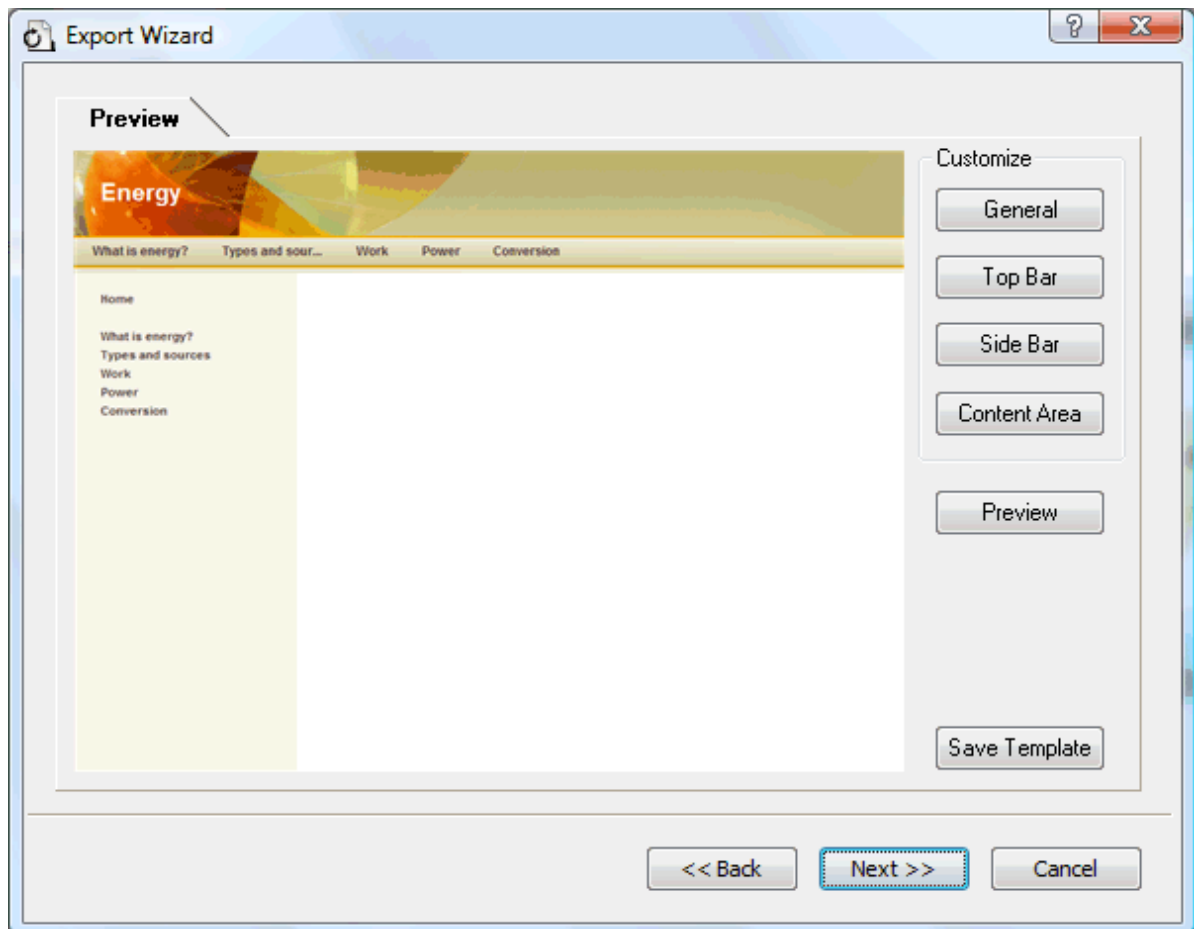

You can customize each area in turn by clicking the **Customize** buttons, namely:

- General
- Top Bar
- Side Bar
- Content Area

Feel free to experiment with the various customization options. At any time, you can obtain a full size preview of your design reflecting any changes made by clicking the Preview button. Note however that this Preview does not allow you to navigate the document.

### **Customizing the General properties (optional)**

- Click **General** in the Preview dialog.

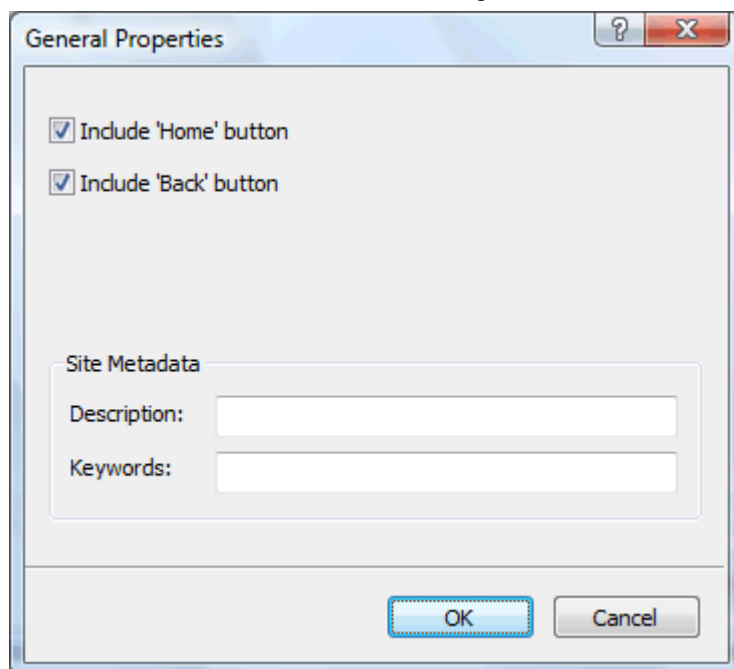

This dialog gives you the following options:

**Include 'Home' button:** This inserts a Home hyperlink or button on each of your Mediator pages, allowing you to return to the page corresponding to the root of your map in just one click.

**Include 'Back' button:** This inserts a Back hyperlink or button on each of your Mediator pages, enabling you to go back to the last page visited.

You can also enter meta-tags for your Mediator document as follows:

**Description:** Any text entered here will be inserted in the Description tag of the Mediator document (visible by clicking the HTML tab of the Document Properties dialog in Mediator).

**Keywords:** Similarly, any keywords entered here (separated by commas) will be inserted in the Keywords tag of the Mediator document (also visible by clicking the HTML tab of the Document Properties dialog in Mediator).

### **Customizing the Top Bar (optional)**

- Click the **Top Bar** button or double-click the top bar area in the Preview dialog.

The Top Bar Properties dialog opens on its **Title** tab.



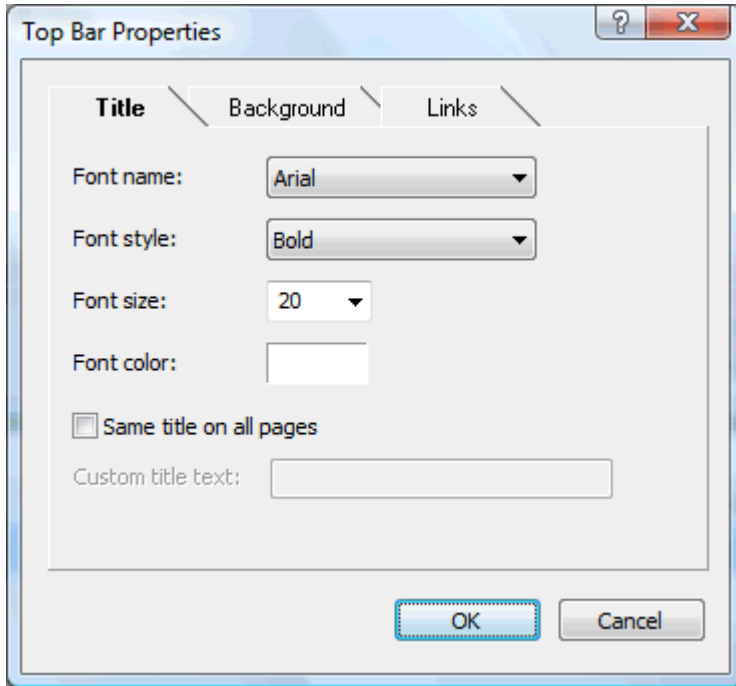

By default, the title displayed on each Mediator page is the branch name. Here you can change the font, attributes and color for this title or even enter your own title, which will be displayed on all the pages of the document.

- Click the **Background** tab.

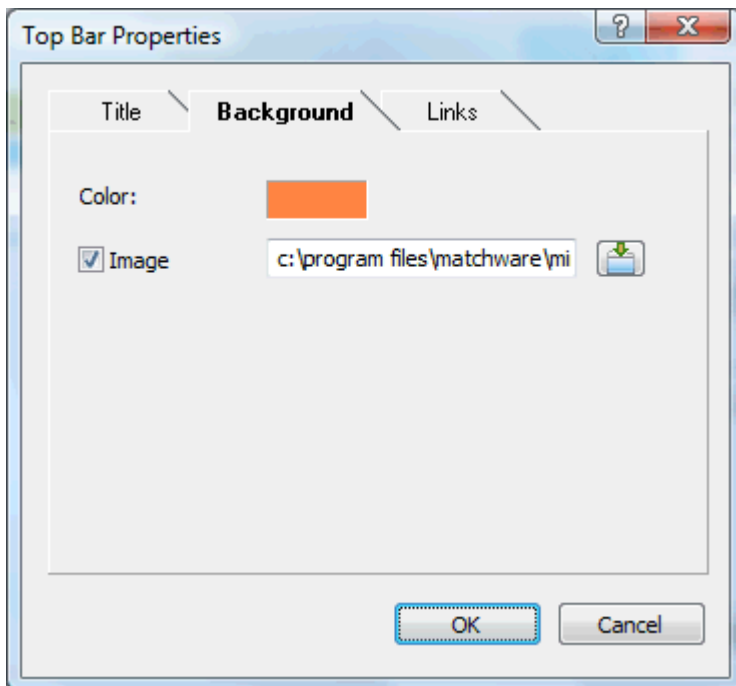

This tab lets you select a plain color or a different background picture for the top bar.

If you want to change the background picture, the best approach is to make a copy of the existing picture and edit its design to suit your requirements, making sure that the picture size stays unchanged so that it still fits the template.

- Click the **Links** tab.

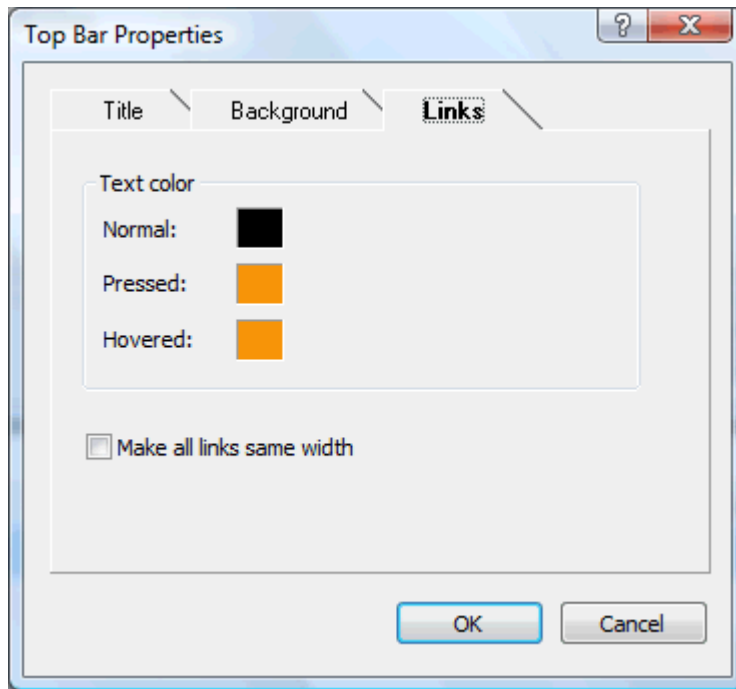

 The Links tab is only available if the top bar of the template chosen contains buttons or hyperlinks.

This tab lets you select different colors for the top bar links depending on their state, i.e. "Normal", "Pressed" (the link is clicked) or "Hovered" (the mouse pointer is placed on the link).

You can also choose to make all the links the same width, or have their width vary according to the length of their label.

#### **Customizing the Side Bar (optional)**

- Click the **Side Bar** button or double-click the side bar area in the Preview dialog.

The Side Bar Properties dialog opens on its **Background** tab.

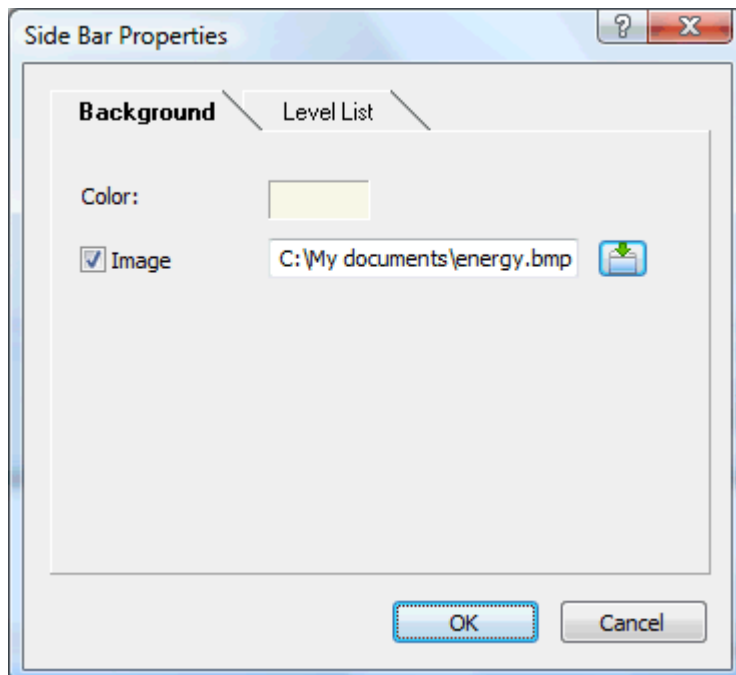

This tab lets you select a plain color or a different background picture for the side bar.

As for the top bar, the best approach if you want to change the background picture is to make a copy of the existing picture and edit its design to suit your requirements.

The second tab of the Side Bar Properties dialog varies depending on the type of navigation template you chose in the first screen of the Export Wizard. The possibilities are:

- Level list
- Links

We will now look at each of these possibilities in turn.

### Level List

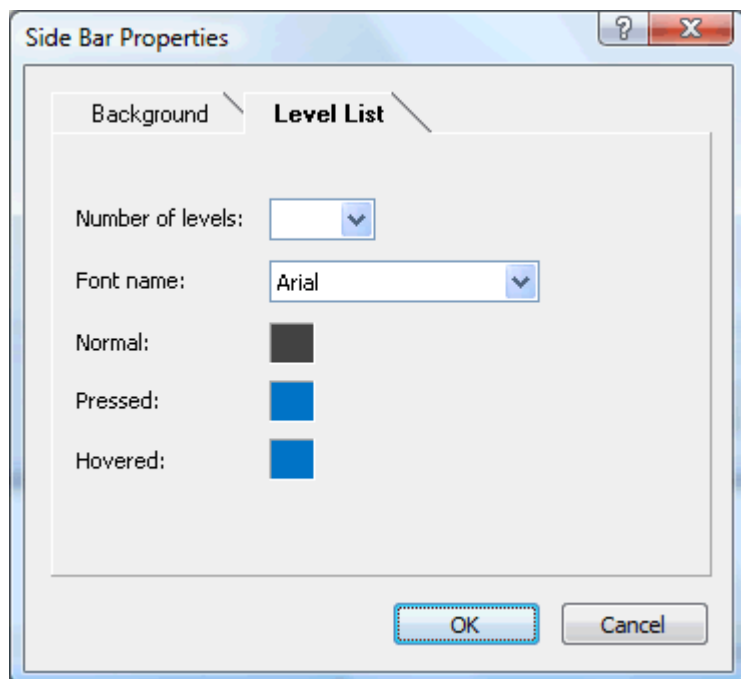

This tab is displayed if you have chosen a Level List design.

With this type of navigation, you only see a maximum of three levels of links on the side: the current page, any pages at the level just above it, and any pages at the level just below it.

The Level list tab lets you choose how many levels the list should show. You can also define the font and color of the links.

### Links

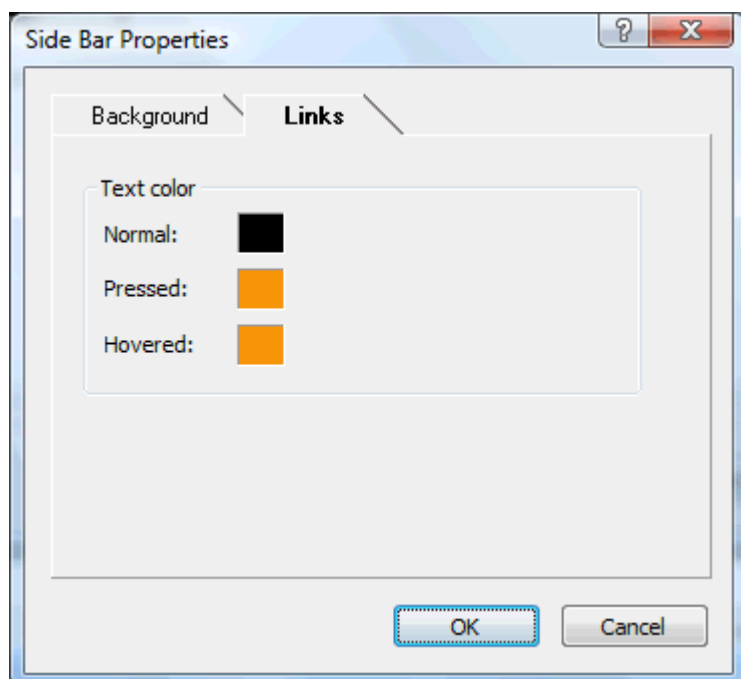

This tab is displayed if you have chosen a Buttons design in the first screen of the Export Wizard. With this design, the side bar contains a list of links, where each link represents a sub-branch of the branch corresponding to the current page. The Links tab lets you select different colors for the side bar links depending on their state, i.e. "Normal", "Pressed" (the link is clicked) or "Hovered" (the mouse pointer is placed on the link).

#### **Customizing the Content Area (optional)**

- Click the **Content Area** button or double-click the middle area in the Preview dialog.

The Content Area properties dialog opens on its **Background** tab.

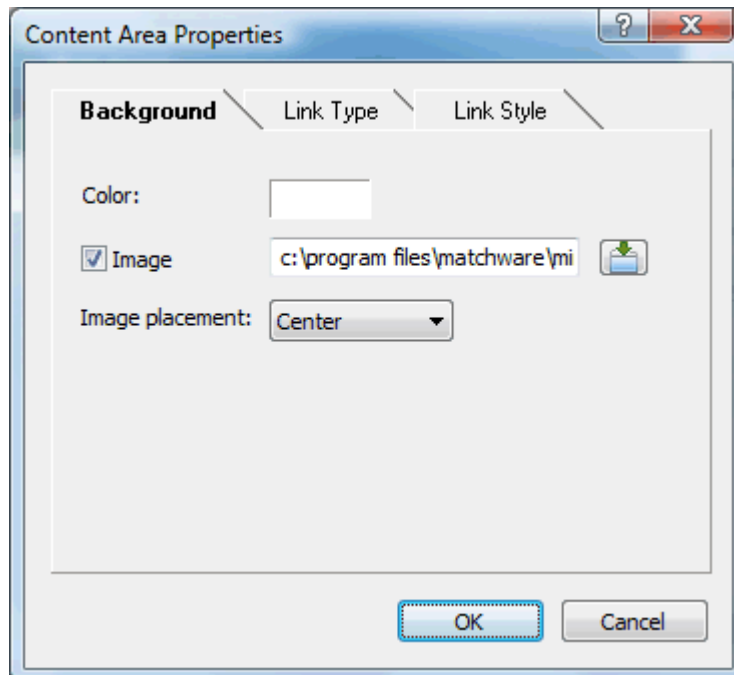

This tab lets you select a plain color or a different background picture for the body of the page. Feel free to experiment with the image placement options by checking the effect in the Full Size Preview.

- Click the **Link Type** tab.

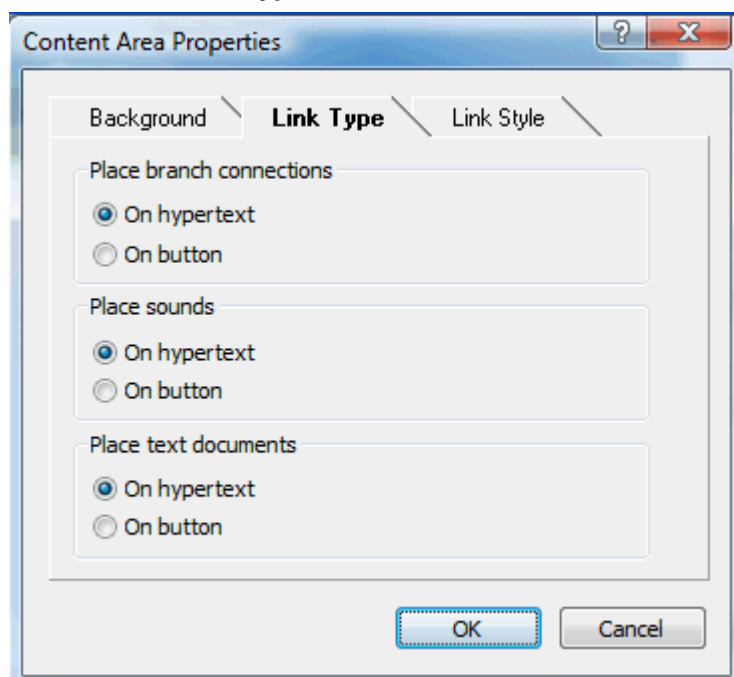

If your map contains branch connections, sound files or attached text documents, this tab lets you decide whether you want to place these objects on Mediator hypertext or button objects.

- Click the **Link Style** tab.

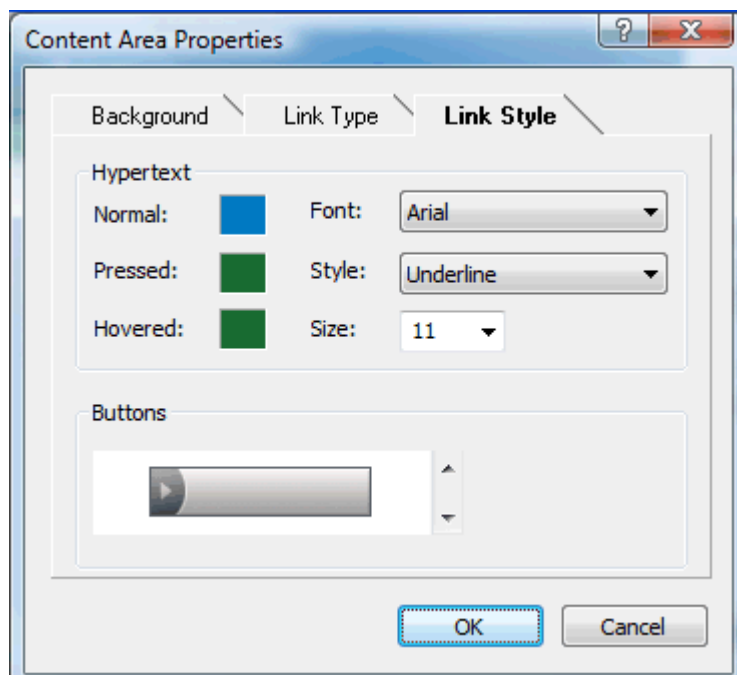

This tab lets you choose styles for any buttons or hyperlinks created on your Mediator pages.

- Define the hypertext style required by selecting a font, attribute and size. You can also define different colors depending on the state of the hyperlink, i.e. "Normal", "Pressed" (the link is clicked) or "Hovered" (the mouse pointer is placed on the link).
- Scroll through the various buttons available to choose the type you like best.

#### **Previewing the customized template (optional)**

- Click the **Preview** button in the Preview dialog to obtain a real-time preview of your design reflecting any changes made so far.

#### **Saving the customized template (optional)**

- You can save your customized export template for later use by clicking the **Save Template** button of the Preview dialog. The Save User Template dialog that opens contains a list of the export templates you have already saved. Enter the name of your new export template and click Save.
- Once you are satisfied with the design of all the page components, click Next.

#### **Selecting the objects to export**

The Export Wizard now opens the **Select Objects to Export** dialog.

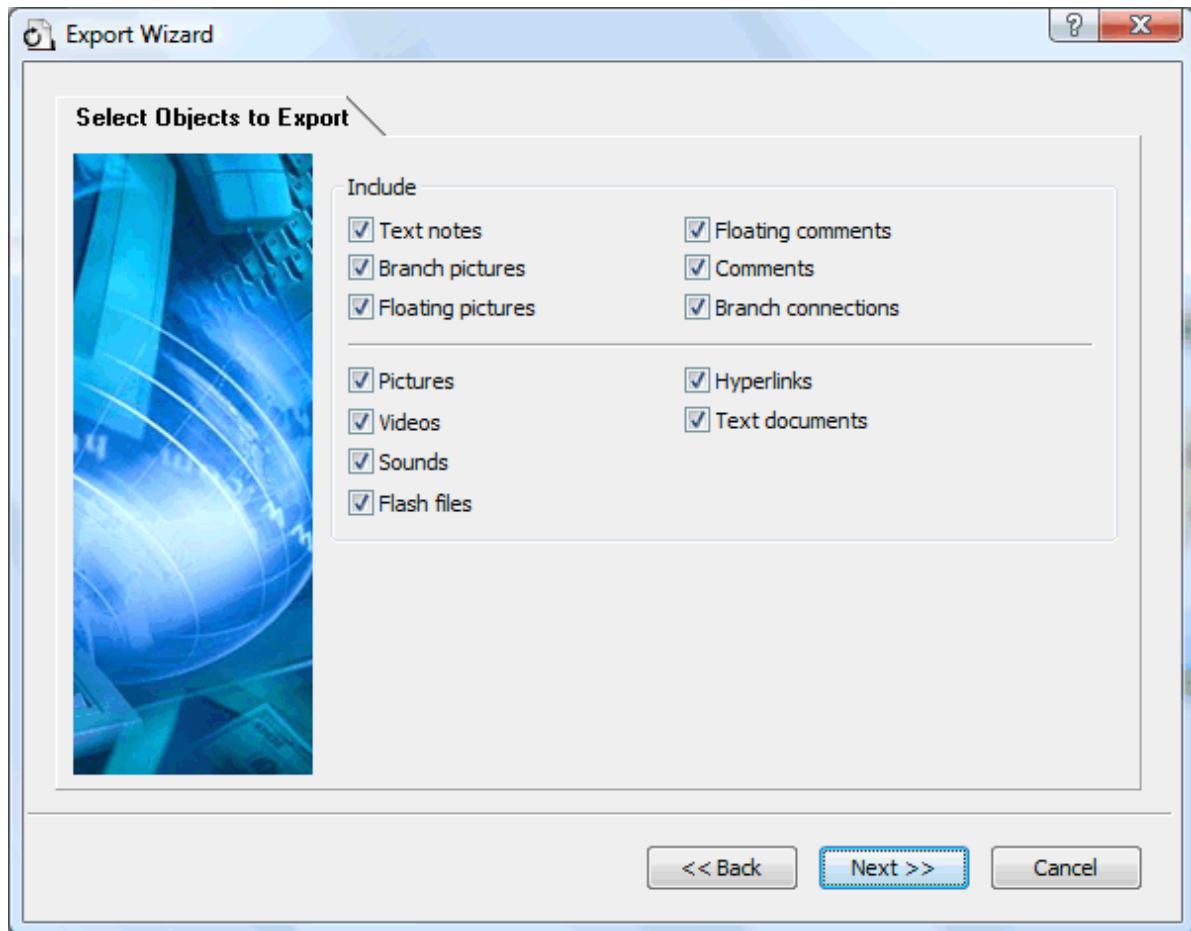

- Select the MindView objects which you want to export to Mediator.



If you exclude some elements from the export by deselecting them here, none of the elements of this type will be exported, regardless of the value of their individual 'Include in export' property in the Properties dialog. Let's suppose for instance your map contains a floating picture whose 'Include in export' property is enabled. If you choose to exclude floating pictures from the export here, your floating picture will not be exported. Conversely, if you specify here that floating pictures should be exported, only the floating pictures whose 'Include in export' property is enabled will be exported.

Include in Export

- Click Next.

## Exporting

You are now ready to export your map to Mediator.

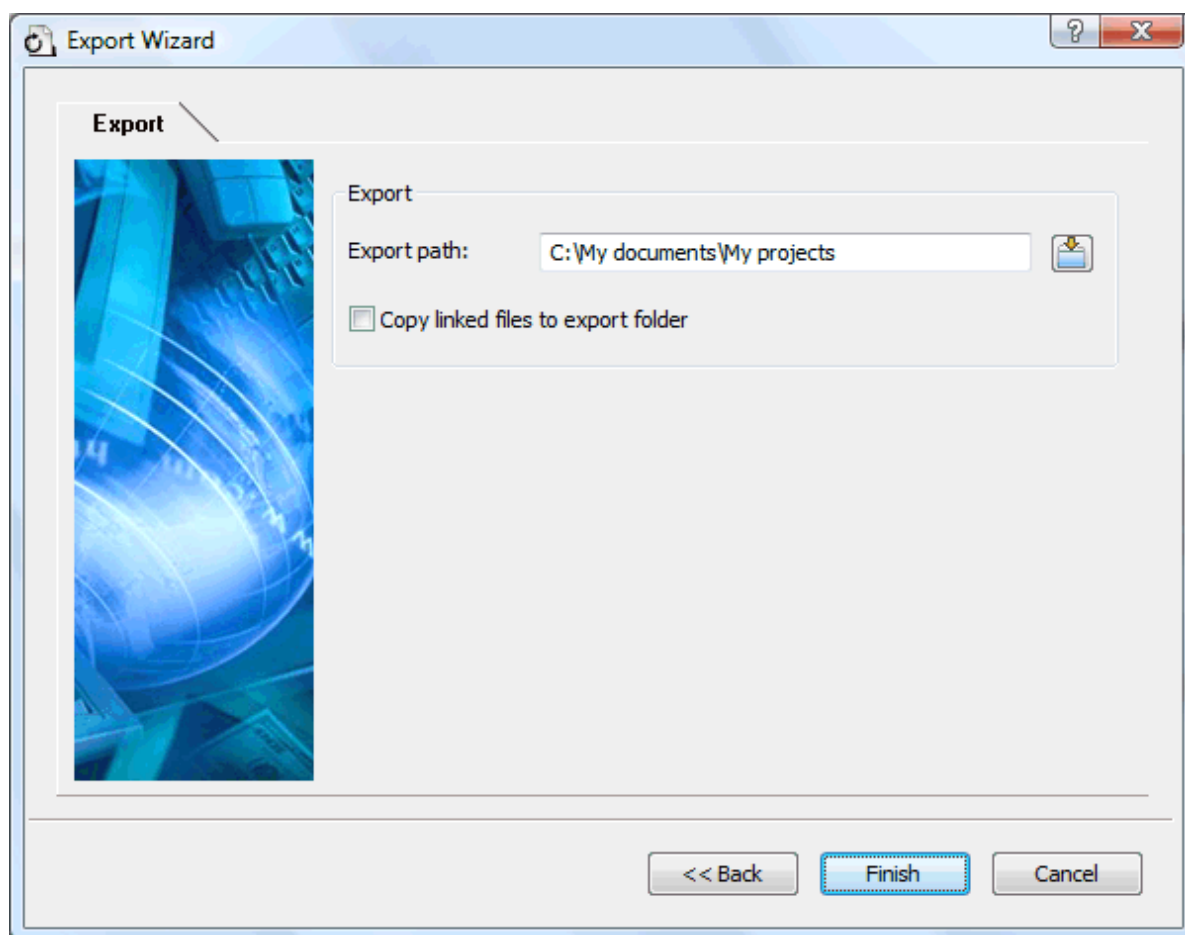

- Choose a path and file name for your new Mediator presentation.
- If you want MindView to place a copy of all the external files used in your map (such as text files, sound files, video files and so on) in the export folder, check the option **Copy linked files to export folder**. Such files will then be placed in the sub-folder named MD8 of your export folder. This will allow you to distribute or transfer your Mediator presentation easily by copying the actual Mediator file as well as the entire MD8 sub-folder.
- Click **Finish**.

 If your MindView document was created by importing a Mediator presentation, a dialog might appear at this point, listing all the branches corresponding to pages created directly in Mediator. Because you might not want to change the appearance of these pages in the new Mediator presentation, you can deselect them in this dialog to indicate that the export template should not be applied to them.

Once the export is completed, MindView lets you either view your presentation straight away in Mediator or continue working in MindView.

 *When exporting the mind map to Mediator, MindView places special tags formatted with # signs in the Notes tab of the Properties dialog of particular elements of the new Mediator presentation, including the pages themselves. These tags contain information required by MindView to re-import the Mediator presentation, should you decide to do so at a later stage. You should take care not to delete these tags if you want to preserve the structure and layout of the original mind map.*



## Exporting to RTF



This export method lets you export your mind map in RTF format. This may be useful if you want to process your document further in a word processor, but do not have Microsoft Word installed on your computer.

Each branch is exported as a paragraph heading at the relevant level, in other words Heading 1 for main branches, Heading 2 for sub-branches, Heading 3 for sub-sub-branches and so on, using hierarchical numbering (unless you disable it in Advanced Export). Attached objects and inserted elements are listed below the heading.

By default, MindView automatically includes an overall picture of your map on the first page of the document.

The branches of the map are exported to RTF in the order in which they are displayed in the Mind Map view, starting from the top right in a clockwise direction.

You can however exclude entire branches and sub-branches from the export by disabling their 'Include in export' property in the Properties dialog.

Include in Export	<input checked="" type="checkbox"/>
-------------------	-------------------------------------

 *Only the branches displayed on the workspace when you start the export procedure are exported. This means that if you are focusing on a particular branch or set of branches (see ["Focusing on a branch"](#)) or if you are filtering the map to display only branches that meet specific criteria (see ["Filtering a mind map"](#)), only the branches visible on the workspace will be exported. To export the entire map, you need to go back to the full display by clearing the branch focus or filter applied.*

### Export modes

There are two export modes available:

- **Quick Export**



The Quick Export mode allows you to export your map quickly using the MindView defaults or the last Advanced Export settings you chose if you have already used that mode.

- **Advanced Export**



The Advanced Export mode allows you to specify the elements of your map to be exported and how they should be treated.

The export settings you choose in Advanced Export are saved with the MindView document and re-used next time you export your map using Quick Export or Advanced Export. This means that you do not have to redefine them every time you make a small amendment to your map and want to export it again to RTF.

### Relationship between MindView and RTF elements and objects

The following table indicates how MindView treats the various inserted elements and attached objects contained in your map when exporting it to RTF.

MindView element	Exported to RTF as
Branch name	Heading at relevant level with hierarchical numbering (3 levels by default) Hierarchical numbering can be disabled in Advanced Export.
Text note	Text inserted under the branch heading
Branch picture	Picture inserted under the branch heading

Floating picture	<ul style="list-style-type: none"> <li>● If connected to a branch, inserted under the branch heading</li> <li>● If not connected to a branch, not exported</li> </ul>
Floating comment	As for Floating picture
Pop-up comment	Text under the branch heading
Branch connection	Cross-reference prefixed by "See section" under the start branch heading, pointing to the end branch heading
<b>MindView object</b>	<b>Exported to RTF as</b>
Text file	Object name followed by hyperlink to file
Picture file	Picture embedded in the RTF document In Advanced Export, you can choose instead to insert the file as an object name followed by a hyperlink to the file.
Video file	Object name followed by hyperlink to file
Sound file	Object name followed by hyperlink to file
Hyperlink	Object name followed by hyperlink to file
Flash file	Object name followed by hyperlink to file

### Using Quick Export

- Click the **File** tab.
- Choose **Export | RTF | Quick RTF Export**.
- If your MindView view contains several maps (i.e. several roots), choose the map you want to export in the 'Select Map to Export' dialog and click OK.
- Specify a folder and a file name for the new RTF document in the Save As dialog.

Once the export is complete, MindView lets you view the document in the viewer associated with the .RTF extension on your computer.

### Using Advanced Export

- Click the **File** tab.
- Choose **Export | RTF | Advanced RTF Export**.
- If your MindView view contains several maps (i.e. several roots), choose the map you want to export in the 'Select Map to Export' dialog and click OK.
- In the **General** tab, choose the required general export settings and specify the elements of the map to export.

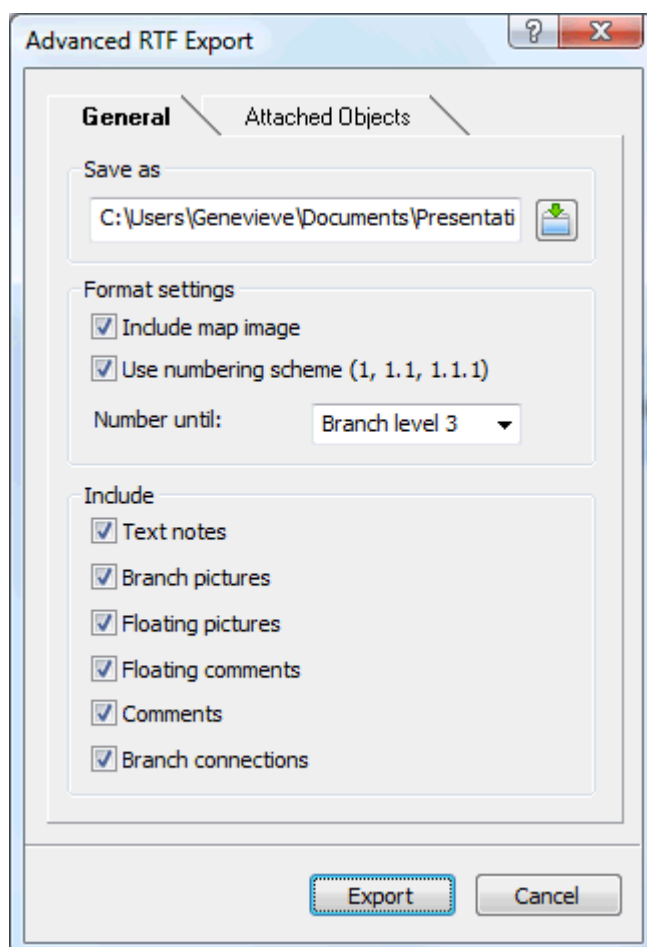

 If you exclude some elements from the export by deselecting them here, none of the elements of this type will be exported, regardless of the value of their individual 'Include in export' property in the Properties dialog. Let's suppose for instance your map contains a floating picture whose 'Include in export' property is enabled. If you choose to exclude floating pictures from the export here, your floating picture will not be exported. Conversely, if you specify here that floating pictures should be exported, only the floating pictures whose 'Include in export' property is enabled will be exported.

Include in Export

- Choose the required export settings for any attached object in the **Attached Objects** tab.

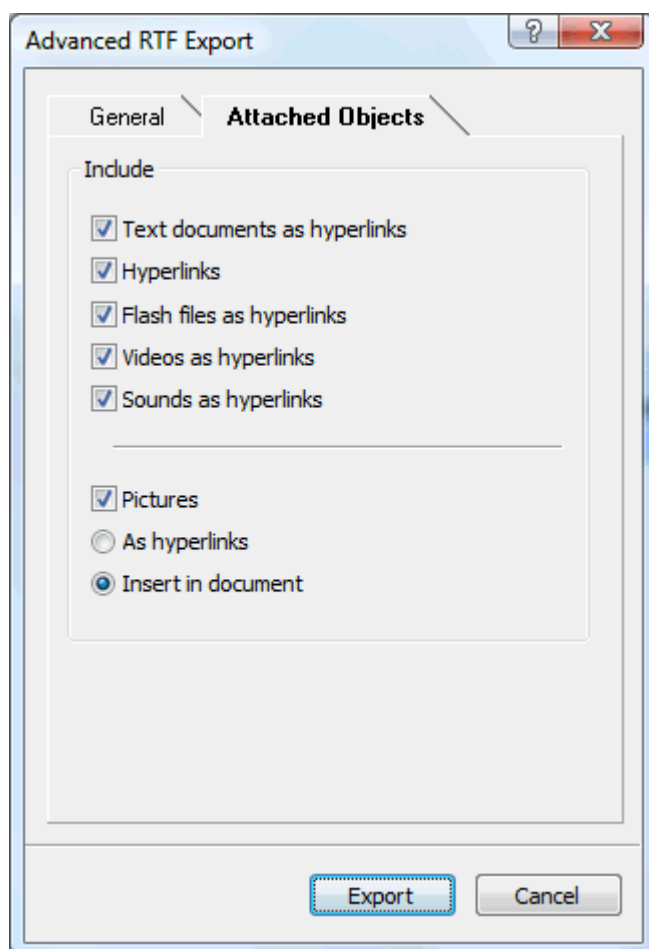

- Click **Export**.

As for Quick Export, MindView starts exporting your mind map to RTF as a new document. Once the export is complete, MindView lets you view the document in the viewer associated with the .RTF extension on your computer.

## Exporting to XML

This export method lets you export your document in XML format.

MindView supports two XML export file types:

- **MindView XML:** This file type allows MindView documents to be converted to other application formats after implementation of a transformation file.
- **Microsoft Project XML:** This file type allows you to create a version of your MindView document that can be opened in Microsoft® Project with the standard File | Open command of that application. You can use the Microsoft Project XML export method even if you do not have Microsoft Project on your computer. It is therefore a useful alternative to exporting directly from MindView to Microsoft Project in the .mpp format, for which you do need to have Microsoft Project installed on your computer.

Only the elements of the MindView project plan that are supported by Microsoft Project are exported. This means that branch pictures, icons, attached objects and so on are not exported. Text notes are exported as Microsoft Project task notes. Pop-up comments are not exported.

## Procedure

- Click the **File** tab.
- Choose **Save As | XML**.
- Choose a file name and a destination for the exported file.
- Choose the required export file type in the Type field.
- Click OK.



The property 'Include in export' of the Properties dialog is ignored when exporting to XML.

## Exporting as picture



This export method lets you save your mind map as a picture file.

- Click the **File** tab.
- Choose **Save As | Picture**.

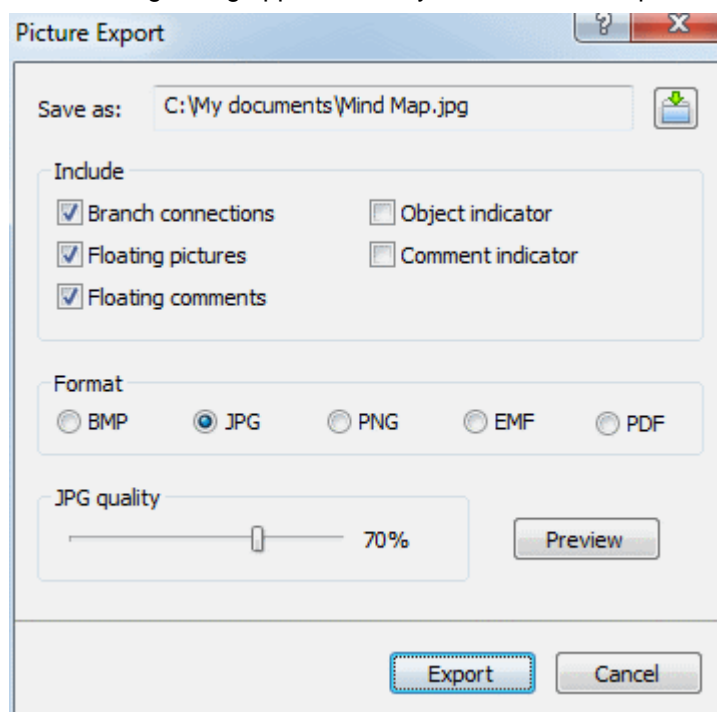

The following dialog appears to let you choose the required export settings.



- Enter the path and file name for the picture in the 'Save as' field or click the Browse button to choose an existing path.
- If you do not want to display branch connections, floating pictures and floating comments in the picture, clear the corresponding check mark.



Since this export method creates a picture of your entire map, all elements chosen above are displayed on the picture, regardless of the value of their individual 'Include in export' property in the Properties dialog. Similarly, all branches will be visible, regardless of the value of their individual 'Include in export' property.

- If you want to display the object indicator  and/or the comment indicator  next to each branch containing attached objects and/or comments, click the relevant check box.
- Choose the required picture format.

If you choose the .jpg format, you can use the 'JPG quality' slider to define the level of quality needed. Note that decreasing the level of quality increases the level of compression, and therefore reduces the file size.

- (optional) Preview the effect of your settings on the picture by clicking Preview.

➤ Click **Export**.

Note that icons and branch pictures are always displayed and that it is not possible to display text notes.

The export settings you choose are saved with the MindView document. This means that you will not have to specify these settings again if you make changes to the map and want to re-export it as a picture.

## Importing

### Introduction



MindView lets you import documents from other applications, including Microsoft® Word, Microsoft® PowerPoint, Microsoft® Excel, MatchWare Mediator, Microsoft® Outlook and Microsoft® Project. You can also create MindView documents by importing XML files.

The import options offered by MindView are all described in detail in the next topics.

### Importing from Microsoft Word



MindView lets you import Microsoft® Word documents.

This is particularly useful when:

- You have a Word document which you would like to restructure using the brainstorming capabilities and features of MindView before exporting it again to Word.
- You have exported a MindView mind map to Word, developed some of the topics in Word, but then realized you need to review the structure of your map in MindView before doing any further work in Word.

In both cases, MindView allows you to import the Word document into a new mind map, preserving the text added in Word together with its formatting as far as possible. Pictures, comments and hyperlinks added in Word are also preserved wherever possible.

If the Word document was created by exporting a MindView mind map to Word, the new mind map will have the same branch structure and layout as the original mind map.

If you then re-export the new mind map to Word after having made the required changes in MindView, any elements added in MindView are exported to the new document.

For more information about the elements that MindView is not able to preserve, see "[Limitations](#)" below.



You do not need to have Microsoft Word installed on your computer in order to import a Word document into MindView. MindView can import documents created with Microsoft Word 2007 and above in the .docx format. If you are using an earlier version of Word, you can use the free Microsoft Office Compatibility pack to convert the document from its .doc format to the newer .docx format prior to importing.

Although MindView can import any Word document, a useful branch structure can only be created if the document is organized in paragraphs containing headings defined with the Microsoft Word heading styles "Heading 1" through to "Heading 9".

MindView imports each paragraph of the Word document as a branch at the relevant level. In other words paragraphs with a Heading 1 title become main branches, paragraphs with a Heading 2 title become sub-branches, paragraphs with a Heading 3 title become sub-sub-branches and so on.

If the Word document starts with a main heading with the style "Title", then this heading is used as the root name. Otherwise the name of the Word document is used as the root name.

### Procedure

- Click the **File** tab.
- Choose **Import | Microsoft Word**.
- Select the Word document you want to import.
- Specify a destination folder and file name for the MindView document to be created.



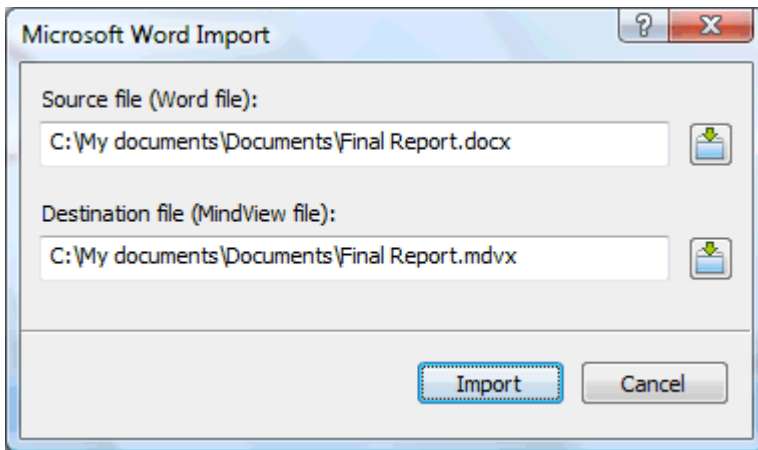

➤ Click **Import**.

There may be elements of the Word document that MindView is not able to import. If this is the case, MindView displays a Warning dialog listing these elements. See "[Limitations](#)" below for more information.

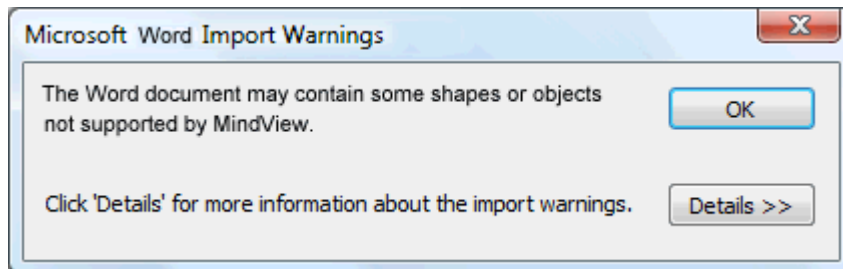

**⚠** *When exporting a mind map to Word, MindView inserts bookmarks in the Word document to keep track of how the various elements should be re-imported back into MindView if you choose to do so. You should take care not to delete these bookmarks, which are hidden by default. To make them visible while you work, check 'Show bookmarks' in the Advanced panel of the Word Options dialog.*

### Relationship between Word and MindView elements and objects

The following table indicates how MindView converts the various elements of your Word document to MindView elements and objects.

Word element	Imported in MindView as
Title (with Title style)	Root of the mind map <ul style="list-style-type: none"> <li>● If the Word document does not contain a Title heading at its very top, the name of the Word document is used as root name.</li> <li>● If the Word document contains more than one Title heading, each such heading is imported as a text note of the corresponding higher level branch.</li> </ul>
Heading 1 (with Heading 1 style)	Main branch
Heading 2 (with Heading 2 style)	Sub-branch of the corresponding higher level branch
and so on until...	
Heading 9 (with Heading 9 style)	Sub-branch of the corresponding higher level branch

Regular text	<ul style="list-style-type: none"> <li>● If the document was created in Word, imported as a text note of the corresponding branch</li> <li>● If the document was created by exporting an original MindView mind map, imported as text note or floating comment of the corresponding branch as in the original document</li> </ul>
Picture embedded in paragraph heading	Floating picture of the corresponding branch
Picture embedded in body text	<ul style="list-style-type: none"> <li>● If the document was created in Word, imported as a picture embedded in a text note of the corresponding branch</li> <li>● If the document was created by exporting an original MindView mind map, imported as branch picture, floating picture or attached picture file of the corresponding branch as in the original document</li> </ul>
Comment	Pop-up comment for the corresponding branch
Intra-document cross reference to heading with style Title or Heading 1 to 9	Branch connection between the relevant branches
Hyperlink	Hyperlink in text note of the corresponding branch

## Limitations

The following limitations apply when importing a Word document into MindView:

- Indexes, tables of contents, tables of authorities, tables of figures, headers and footers are not imported.  
Note that you can choose to have the Table of Contents regenerated automatically when re-exporting the mind map to Word.
- Sounds and videos that are embedded in the Word document are not imported in MindView. To import such elements in the MindView mind map, make sure they are inserted in the Word document as hyperlinks.
- Editable Word shapes such as AutoShapes, Text Effects (WordArt) and diagrams are imported in the MindView document as pictures. This means that when re-exported to Word, they become standard pictures and do not keep their original editable properties.
- Mathematical symbols are not imported.

In addition, if you are importing a document created from an original MindView mind map, the following limitations apply:

- Pop-up comments will not retain their original size and position.
- Pictures embedded in the Word document as a result of the export from MindView do not retain their file name information. When re-importing the document, MindView creates new files for these pictures.
- If you chose to include a picture of the whole mind map in the Word document when exporting from MindView, this picture is not re-imported back into MindView.

## Importing from Microsoft PowerPoint



MindView lets you import Microsoft® PowerPoint presentations.

This is particularly useful when:

- You have a PowerPoint presentation which you would like to expand using the brainstorming capabilities and features of MindView before exporting it again to PowerPoint.

- You have exported a MindView mind map to PowerPoint, worked on the layout in PowerPoint, but then realized you need to review the structure of your map in MindView before doing any further work in PowerPoint.

In both cases, MindView allows you to import the PowerPoint presentation into a new mind map, preserving as much of the layout and contents of the PowerPoint presentation as possible.

If the PowerPoint presentation was created by exporting a MindView mind map to PowerPoint, the new mind map will have the same branch structure and layout as the original mind map.

If you then re-export the new mind map to PowerPoint after having made the required changes in MindView, any elements added in MindView are exported to the new presentation.

For more information about the elements that MindView is not able to preserve, see "[Limitations](#)" below.



You must have Microsoft PowerPoint installed on your computer in order to import a PowerPoint presentation into MindView. MindView supports all Microsoft PowerPoint versions from 2000 onwards.

## Procedure

- Click the **File** tab.
- Choose **Import | Microsoft PowerPoint**.
- Select the PowerPoint presentation you want to import.
- Select the destination folder, i.e. the folder for the MindView document created from the PowerPoint presentation.
- (optional) If you want to import the bullet lists that may be included on the PowerPoint slides as sub-branches of the corresponding branches, check **Import bullets as branches**. If you leave this box unchecked, the bullet lists that may be included on the PowerPoint slides are inserted as text notes on the corresponding MindView branches.

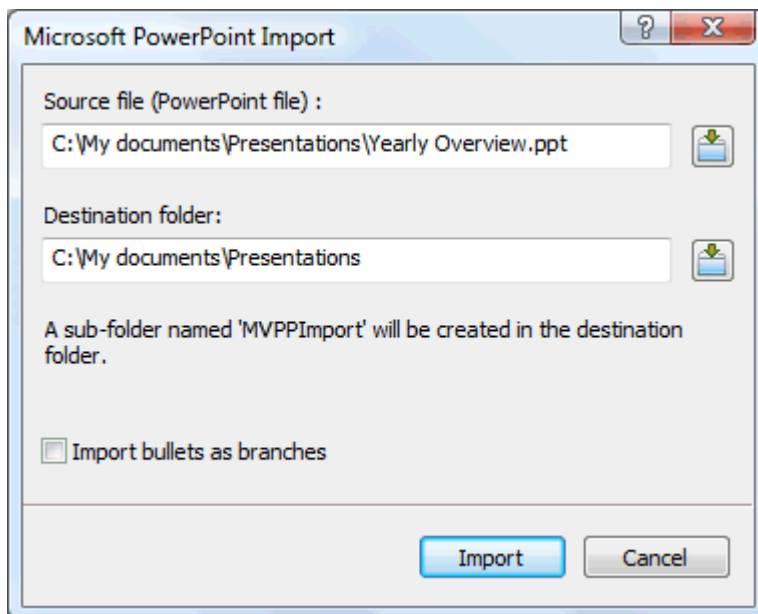

- Click **Import**.

MindView creates a sub-folder named 'MVPPImport' within the destination folder and places in it the new MindView document as well as any pictures or other objects such as sounds or videos embedded in the PowerPoint presentation.

There may be elements of the PowerPoint presentation that MindView is not able to import. If this is the case, MindView displays a 'PowerPoint Import Warnings' dialog listing these elements. See "[Limitations](#)" below for more information.

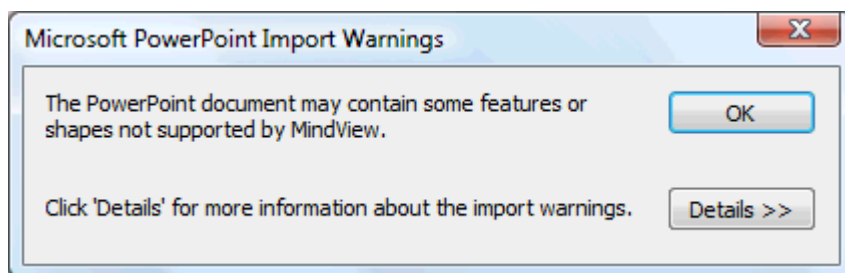

## Import modes

The Import operation has two modes depending on how the PowerPoint presentation was created:

- The PowerPoint presentation was originally created in PowerPoint  
 In this mode, the title of the first slide becomes the root name of the new MindView document. If you have checked the 'Import bullets as branches' option, each bullet list item of that first slide becomes a new main branch. If not, the entire bullet list is imported as a text note for the root.  
 All the other slides are imported as further main branches. If you have checked the 'Import bullets as branches' option and some of those slides contain bullet lists, each bullet list item becomes a sub-branch of the corresponding MindView branch. If not, the entire bullet list is imported as a text note for the branch.
- The PowerPoint presentation was created by exporting a MindView document  
 In this mode, the original branch structure of the MindView document is preserved, provided that you have not removed any slide. If you have added new slides, they are imported as main branches.

## Relationship between PowerPoint and MindView elements and objects

The following table indicates how MindView converts the various elements of your PowerPoint presentation to MindView elements and objects.

PowerPoint element	Imported in MindView as
Slide	Branch
Slide title	Branch title
Slide sub-title	Text note
Slide body text	Text note
Slide bullet list	<ul style="list-style-type: none"> <li>● If the presentation was created in PowerPoint and you checked 'Import bullets as branches' in the Import dialog, each bullet is imported as a sub-branch. If you didn't check 'Import bullets as branches', the entire bullet list is imported as a text note for the branch.</li> <li>● If the presentation was created by exporting an original MindView document, the branch structure of the mind map is recreated from the slide titles, not from the bullet list. The text of the bullet list is therefore ignored.</li> </ul>
Slide comment	Floating comment
Slide notes	Pop-up comment
Embedded picture	<ul style="list-style-type: none"> <li>● If the presentation was created in PowerPoint, imported as an attached picture object stored in the 'MVPPIImport' folder</li> <li>● If the presentation was created by exporting an original MindView document, imported as a branch picture or floating picture as in the original document</li> </ul>
Autoshape	Attached picture object stored in the 'MVPPIImport' folder

Linked picture	Attached picture object pointing to the original path
Embedded video	Attached video object pointing to the original path
Embedded sound	Attached sound object stored in the 'MVPPImport' folder
Link to slide	Branch connection

## Limitations

The following limitations apply when importing a PowerPoint presentation into MindView:

- The formatting of the slide title and of any slide notes included is not preserved.
- If the layout of the PowerPoint slide contains more than one bullet list, only the first bullet list is taken into account by the import.
- When importing bullets as branches, indented bullets within the main bullet list are imported as branches of the same level as the main bullets, not as sub-branches.
- PowerPoint master slides are not taken into account by MindView. Their contents are therefore not imported into the MindView document.
- Although hyperlinks contained in PowerPoint text objects are imported into the corresponding MindView text note, only their formatting is preserved. The links themselves are not preserved.
- The following PowerPoint objects are imported as pictures in the MindView document and listed in the 'PowerPoint Import Warnings' dialog:
  - AutoShapes
  - OLE controls, embedded OLE objects and linked OLE objects
  - Diagrams
  - Tables
  - Text Effects (WordArt)

All other unknown shapes also cause the display of the 'PowerPoint Import Warnings' dialog, but are otherwise ignored.

- If you are using PowerPoint 2003 and above, the picture files that are created in the 'MVPPImport' folder have the .png extension. This means they can be stretched with antialiasing, resulting in higher quality. With PowerPoint 2000, the picture file format used is .gif. This file format cannot be stretched with antialiasing.

In addition, if you are importing a presentation created by exporting a MindView document, the following limitations apply:

- If you delete one or more slides while working in PowerPoint, MindView is not able to recreate the branch structure exactly as in the original mind map:
  - If you delete the slide corresponding to the root branch, all the slides are imported as main branches, as if you had created the presentation from scratch in PowerPoint.
  - If you delete slides corresponding to branches with sub-branches, MindView cannot recreate the structure of these sub-branches.
- Similarly, if you rearrange the slides in a different order in PowerPoint, MindView does not take the new order into account.
- Since MindView uses the PowerPoint slide titles to recreate the branch structure, any changes you make to the bullet list text in PowerPoint will not be preserved in MindView.
- Pop-up comments will not retain their original size and position.
- Pictures embedded in the PowerPoint presentation as a result of the export from MindView do not retain their original file name or path information. When re-importing the presentation, MindView creates new files for these pictures in the 'MVPPImport' folder.
- If you chose to include a picture of the whole mind map in the PowerPoint presentation when exporting from MindView, the slide containing this picture is not re-imported back into MindView.

## Importing from Microsoft Excel



MindView lets you import Microsoft® Excel spreadsheets. The spreadsheet might be one that was previously exported from MindView, or one that you are bringing into MindView for the first time.



You must have Microsoft Excel 2003 or above installed on your computer in order to use this import mode.

To ensure a successful import, your spreadsheet should have one of the following layouts:

Title		Header 1	Header 2
	Root	Data	Data
1	Main	Data	Data
1.1	Sub	Data	Data
1.1.1	Sub	Data	Data
2	Main	Data	Data
2.1	Sub	Data	Data

**Numbered**

Title			Header 1	Header 2
Root			Data	Data
	Main		Data	Data
		Sub	Data	Data
			Sub	Data
	Main		Data	Data
		Sub	Data	Data

**Structured**

Title	Header 1	Header 2
Root	Data	Data
Main	Data	Data
Main	Data	Data
Main	Data	Data
Main	Data	Data
Main	Data	Data
Main	Data	Data

**Flat**

If your spreadsheet does not follow one of these layouts, Mind View will nevertheless attempt to import it, following information you supply on the Import dialog (see below).



In addition to the layouts above, MindView is also able to re-import mind maps exported to Microsoft Excel using the "Show subtotals at bottom of group" option." See "[Exporting to Microsoft Excel](#)" for more information about this feature.

The diagrams above show how the contents of the spreadsheet will be imported to a mind map. For example, the contents of the cell labeled 'Root' provides the label for the root of the imported mind map. Whatever is in the cells labeled 'Main' in the diagram will be imported as main branches, and whatever is in the cells labeled 'Sub' will be imported as sub-branches. The contents of the cells labeled 'Data' will be imported as branch data, with the contents of the cells labeled 'Heading 1', 'Heading 2' and so on providing the labels for the data or calculation fields. If the headings are standard MindView task data headings (Start, End, Duration, Completion, Priority or Resources) the data will be imported to the appropriate locations in MindView. If the headings are not standard MindView headings the data will be imported as calculation values. See "[Inserting task data](#)" and "[Inserting calculation values](#)" for more information on these topics).

- In the **Numbered** layout you use the second column to contain the text that will become branch labels, while the numbers in the first column (which must also be formatted as text) indicate the hierarchy. The numbers take the form number.number.number..., the dots marking a change of level in the hierarchy. The following diagram shows how cells in an Excel document (left) import to a mind map (right):

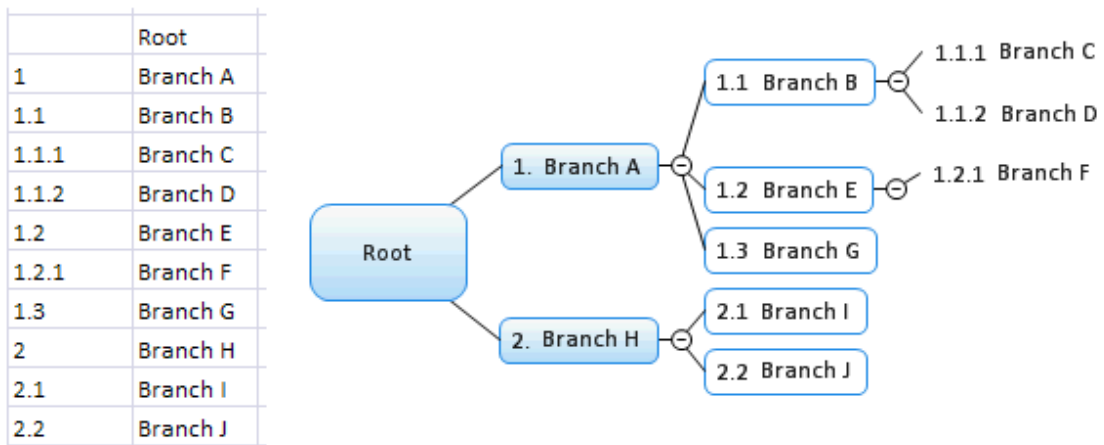

The root is not included in the numbering scheme.

- In the **Structured** layout you use the columns on the left to contain the text that will become root and branch labels, and also indicate the hierarchy. The first column contains the root, the second column the main branches, the third column first level sub-branches, and so on.
- In the **Flat** layout, the leftmost column contains the text that will become branch labels. After the root, each entry is imported as a main branch. No sub-branches are created.

If your spreadsheet does not have one of these layouts, you may nevertheless be able to import it by indicating manually on the import dialog which areas of the spreadsheet represent branch text, which represent data fields and so on (see below).

### Procedure

- Click the **File** tab.
- Choose **Import | Microsoft Excel**.  
You will see a dialog box reminding you of the preferred layouts, described above.
- Select the Excel document you want to import and click OK.

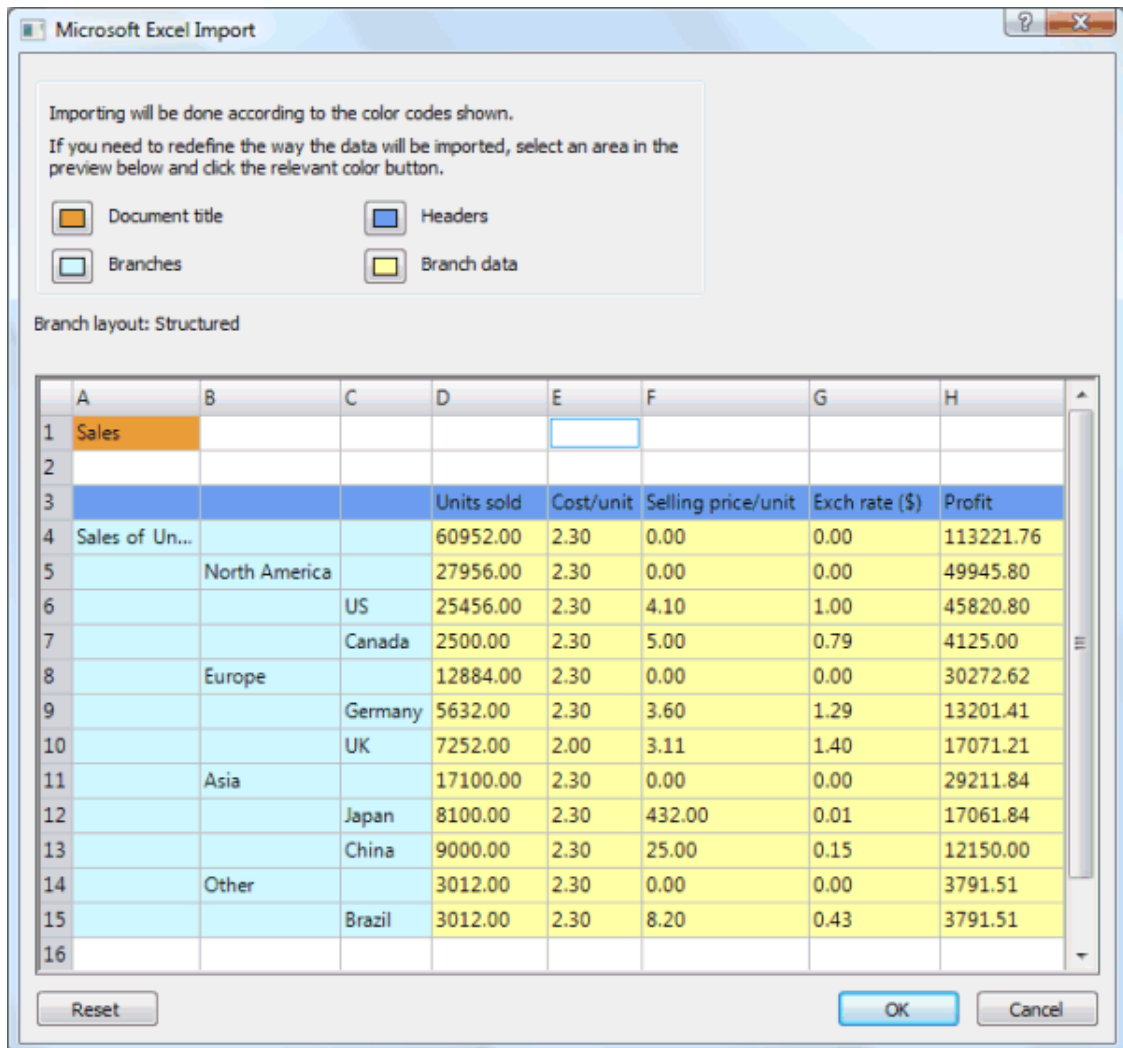

- If necessary, adjust the colored areas that indicate how the spreadsheet contents will be mapped to the mind map. To do this, select an area and click the appropriate color button. You can resize the dialog if you need to.
  - The contents of the **orange** cell in the top left becomes the title of the mind map.
  - The contents of the cells in the **light blue** area become the root and branch labels. By adjusting this area you can choose to import all branches or a subset of branches, but the area must not contain any blank rows. If the leftmost column in the area contains just one filled cell, the content of that cell becomes the root label. If the leftmost column in the



area contains more than one filled cell, the contents of those cells become first level branches under a root whose label is taken from the title cell.

- The contents of the cells in the **yellow** area become data values or calculation values, depending on the column headings (see below). By adjusting the yellow area you can specify which data columns are to be imported.
- The contents of the **dark blue** area are headings for the data columns. If the headings are standard MindView task data headings (such as Start, End, Duration, Completion, Priority, Resources and so on) the data will be imported to the appropriate locations in MindView. If the headings are not standard MindView ones the data will be imported as calculation values. See "[Inserting task data](#)" and "[Inserting calculation values](#)" for more information on these topics).

If you select an area that MindView cannot interpret, you will see a message "Invalid branch layout". Common reasons for this message are:

- You have data in cells that should be empty.
- You have empty cells, for example blank rows, where data is expected.
- In a structured layout, you have skipped one or more levels.
- In a numbered layout, the first column does not contain text in the form of number(s) separated by dots. Every number in this column must be in text format, not in number format.
- In a numbered layout, the cell to the left of the root label is not blank.

To overcome the problem adjust one or more of the colored areas, or click **Cancel**, adjust the layout of the source spreadsheet, and try importing again.

To reset the areas to their state when you opened the dialog, click **Reset**.

- Click OK.

The imported spreadsheet opens in the Mind Map view.

## Importing from Microsoft Outlook



MindView lets you import Microsoft® Outlook task lists. This is particularly useful when for instance:

- You have started a task list in Microsoft Outlook which you would like to expand using the brainstorming capabilities and features of MindView.
- You have exported a MindView task list to Microsoft Outlook, started adding tasks or editing existing ones, but then realized you need to review the structure of your task list in MindView before doing any further work in Microsoft Outlook.

In both cases, MindView allows you to import the Microsoft Outlook task list as a new document in the Mind Map view.

Once you have made the required changes in MindView, you can either re-export the task list to Outlook as a new series of tasks, or synchronize the edited MindView version with the original Outlook version. For more information on exporting and synchronizing from MindView to Outlook, see "[Exporting to Microsoft Outlook](#)".



You must have Microsoft Outlook 2000 or above installed on your computer in order to use this import mode.

### Procedure

- Click the **File** tab.
- Choose **Import | Microsoft Outlook | Import as New Document**.
- Select the Outlook task folder whose tasks you want to import.



If the Outlook folder contains tasks that you have already imported to a MindView document or exported from a MindView document previously, you might prefer to find the MindView document in question and synchronize the task folder with it rather than creating a new MindView document.

The imported task list opens in the Mind Map view.

## Limitations

Only the elements of the Microsoft Outlook task list that have an equivalent in MindView are imported and shown in the Task/Timeline panel:

- Task names, dates, durations, priorities and completion levels are all imported.
- Outlook task notes are imported as pop-up comments.
- Other information corresponding to features that are not supported in MindView, such as status, reminders, categories and so on, as well as any user-defined field, is not imported.

## Synchronizing the Outlook task list and the MindView document

If you have made changes to your task list in Outlook after having exported it from MindView, you can import these latest changes to the MindView version of the task list as follows:

- Click the **File** tab.
- Choose **Import | Microsoft Outlook | Synchronize Tasks**.

The **Synchronization from Microsoft Outlook to MindView** dialog opens.

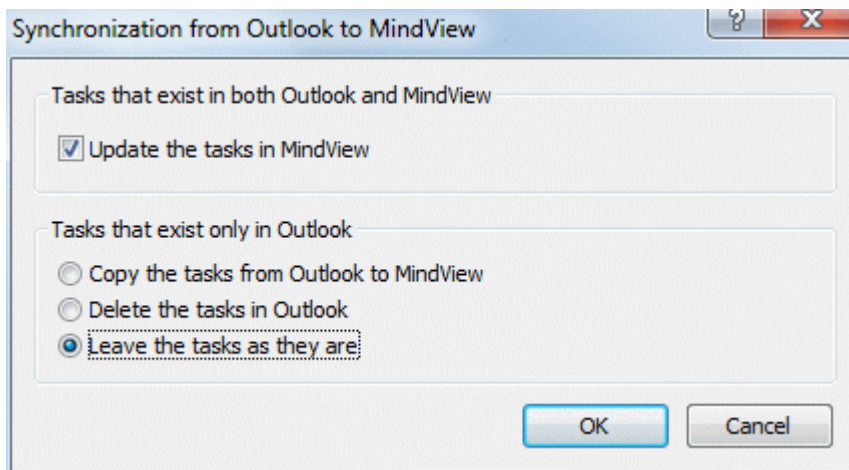

The top part of the dialog determines what will happen when the same task exists in both the Outlook task list and the MindView document in two different forms.

- To copy the task from the Outlook task list to the MindView document, check **Update the tasks in MindView**.

The bottom part of the dialog lets you specify what should happen if a task present in the Outlook task list cannot be found in the MindView document. You have three choices:

- Copy the task from the Outlook task list to the MindView document
- Delete the task from the Outlook task list, so that it does not exist any longer in either version
- Leave things as they are

If conversely you have made changes to your MindView document after having exported it to Outlook, you can export these latest changes to the Outlook version of the task list. For more information about this procedure, see "[Exporting to Microsoft Outlook](#)".

## Importing from Microsoft Project



MindView lets you import Microsoft® Project plans. This is particularly useful when for instance:

- You have started a project plan in Microsoft Project which you would like to expand using the brainstorming capabilities and features of MindView.
- You have exported a MindView project plan to Microsoft Project, starting adding tasks or editing existing ones, but then realized you need to review the structure of your plan in MindView before doing any further work in Microsoft Project.

In both cases, MindView allows you to import the Microsoft Project plan as a new project plan in the Gantt view.



MindView does not support versions of Microsoft Project prior to 2003. You need to have Microsoft Project installed on your computer in order to use this import method.



*You can also import Microsoft Project plans via XML. The advantage of this method is that you do not need to have Microsoft Project installed on your machine. See "[Importing from XML](#)" for more information.*

### Procedure

- Click the **File** tab.
- Choose **Import | Microsoft Project**.
- Select the Microsoft Project plan you want to import.

The imported project plan opens in the Gantt view.

### Limitations

The MindView Gantt view does not support all the project management features offered by Microsoft Project. This means that only the elements of the Microsoft Project that have an equivalent in MindView will be imported:

- Task names, task types, dates, durations, lead and lag times, resources, work units, costs, priorities, completion levels, links, constraints and so on are all imported.
- Project and resource calendars are imported.
- Milestone tasks are imported, but their duration is set to zero.
- Task notes are imported as text notes.
- Other Microsoft Project information corresponding to features that are not supported in MindView (such as baselines, task calendars, work contours and so on) is not imported. Information derived from tracking and leveling operations in Microsoft Project is not imported.

In most cases, the tasks dates and scheduling information will be identical in MindView and in Microsoft Project. They may differ if advanced operations not supported by MindView (such as leveling or tracking) have been performed on the project in Microsoft Project.

## Importing from Mediator



MindView lets you import Mediator presentations.

This is particularly useful when:

- You have a Mediator presentation which you would like to expand using the brainstorming capabilities and features of MindView before exporting it again to Mediator.
- You have exported a MindView mind map to Mediator, added interactivity to it in Mediator using events and actions, but then realized you need to review the structure of your map in MindView before doing any further work in Mediator.

In both cases, MindView allows you to import the Mediator presentation into a new mind map, preserving as much of the structure and contents of the Mediator presentation as possible.

If the Mediator presentation was created by exporting a MindView mind map to Mediator, the new mind map will have the same branch structure and layout as the original mind map.

If you re-export the new mind map to Mediator after having made the required changes in MindView, any elements added in MindView are exported to the new presentation. Note that although MindView creates a new Mediator presentation when re-exporting, the original Mediator document must remain accessible. If it is no longer accessible, MindView cannot preserve the elements of the original presentation that are specific to Mediator (such as events and actions or Mediator objects that have no equivalent in MindView).

For more information about the elements that MindView is not able to preserve, see "[Limitations](#)" below.



You must have Mediator 8 with Service Pack 3 or above installed on your computer in order to import a Mediator presentation into MindView.

This free Mediator 8 update is available on the MatchWare web site at:

<http://www.matchware.com/en/support/servicepacks/mediator8.htm>

If the Mediator presentation was created by exporting a MindView mind map to Mediator, you will need to have Mediator 9 or above installed in order to re-import it into MindView.

MindView imports the first Mediator page as the root of the new MindView document, and all the other Mediator pages of the same level as further main branches. Mediator sub-pages become sub-branches of the corresponding MindView branch and so on.

### Procedure

- Make sure the Mediator presentation to be imported is not already open in Mediator.
- Click the **File** tab.
- Choose **Import | MatchWare Mediator**.
- Select the Mediator presentation and click **Open**.

MindView creates a new document and import the Mediator presentation into it.

### Relationship between Mediator and MindView elements and objects

The following table indicates how MindView converts the various elements of your Mediator presentation to MindView elements and objects.

Mediator element	Imported in MindView as
Page	Branch Note that the Mediator page description is used as the branch name. If the Description field is empty, then the page name is used.
Page note (Notes tab of the Properties dialog)	Pop-up comment
Picture object	<ul style="list-style-type: none"> <li>● If the presentation was created in Mediator, imported as an attached picture object</li> <li>● If the presentation was created by exporting an original MindView document, imported as a branch picture, floating picture or attached picture object as in the original document</li> </ul>
Text object	<ul style="list-style-type: none"> <li>● If the presentation was created in Mediator, imported as a text note for the branch</li> <li>● If the presentation was created by exporting an original MindView document, imported as a text note or as a floating comment as in the original document</li> </ul>

Hypertext object	Text note
Button object	<ul style="list-style-type: none"> <li>● If the presentation was created in Mediator, not imported</li> <li>● If the presentation was created by exporting an original MindView document, imported as a branch connection, an attached text object or an attached sound object as in the original document</li> </ul>
Flash object	Attached Flash object
Media Player object	Attached video object
All other Mediator objects and elements	These are not imported. They are however preserved if you re-export the MindView document to Mediator, provided that the original Mediator document is still accessible.

## Limitations

The following limitations apply when importing a Mediator presentation into MindView:

- If the first page in the Mediator presentation contains sub-pages, these sub-pages are not imported.
- When importing a Mediator hypertext object into MindView, the hypertext object is converted to a text note. This means that any events and actions that may be associated with it in the original Mediator presentation are not preserved when re-exporting the MindView document to Mediator.
- Once the presentation is imported into MindView, if you change the name of a branch and re-export the presentation, the Description field of the corresponding Mediator page will be changed to the new name, but the Page name will remain unchanged.

In addition, if you are importing a Mediator presentation created by exporting an original MindView mind map to Mediator, the following limitations apply:

- When exporting a mind map to Mediator, MindView places special tags formatted with # signs in the Notes tab of the Properties dialog of particular elements of the new Mediator presentation, including the pages themselves. These tags contain information required by MindView to re-import the Mediator presentation. If you delete one or more of these tags by accident, MindView will not be able to recreate the corresponding element(s) exactly as in the original mind map.
- When exporting a mind map to Mediator, MindView hyperlinks, branch connections, attached text files and attached sound files are converted to Mediator buttons containing the relevant events and actions. An attached sound object in the MindView document for instance becomes a button with a Mouse Click event and a Sound action in the Mediator presentation. If you delete or move these events and actions while working in Mediator, although MindView will be able to recreate the original object, the link path will be lost.

## Importing from XML

This import method lets you create MindView documents by importing files in various XML formats into MindView.

MindView supports the following XML import file types:

- **MindView XML:** This file type allows you to open MindView documents previously exported in the MindView XML format.
- **Microsoft Project XML:** This file type allows you to create a MindView project plan by importing a Microsoft® Project plan exported from Microsoft Project in the XML format. You can use the Microsoft Project XML import method even if you do not have Microsoft Project on your computer. It is therefore a useful alternative to importing a Microsoft Project plan in the .mpp format, for which you do need to have Microsoft Project installed on your computer.

The same limitations apply when importing a Microsoft Project XML file as when importing a Microsoft Project .mpp file. For more information, see "[Importing from Microsoft Project](#)".



MindView does not support versions of Microsoft Project XML prior to 2003.

- **MindManager XML:** This file type allows you to create a MindView document by importing a MindManager® document exported from MindManager in the XML format. You can use the MindManager XML import method even if you do not have MindManager on your computer.  
Note that elements of the MindManager file that do not have an equivalent in MindView are not imported. MindView supports MindManager XML files from versions X5 and 6.
- **MindManager MMAP:** This file type allows you to create a MindView document by importing a MindManager® document in the .mmap format. You can use the MindManager MMAP import method even if you do not have MindManager on your computer.  
Note that elements of the MindManager file that do not have an equivalent in MindView are not imported.

### Procedure

- Click the **File** tab.
- Choose **Import | XML**.
- Choose the required import file type in the Type field.  
 *The Autodetect XML file type presented by default lets MindView detect automatically the type of the XML file you specify, provided that it is one of the supported XML file types.*
- Click OK.

The imported file opens in the Mind Map view.

### Importing from other applications



MindView lets you import documents from other Mind Mapping applications, namely Mindjet MindManager (from version X5 onwards) and FreeMind, so that you can develop them further in MindView.

- Click the **File** tab.
- Choose **Import | Other Mind Mapping Applications**.
- Choose **Import from Mindjet MindManager** or **Import from FreeMind**.
- Select the document you want to import.
- Specify a destination folder and file name for the MindView document to be created.

## Pen Mode

### Working in Pen Mode



MindView supports pen input as well as standard keyboard/mouse input, letting you insert digital ink data such as handwritten text and hand-drawn pictures on your branches. Although MindView's pen input features let you treat your computer mouse as a pen, they are designed for use with dedicated pen input devices such as tablet PC's, external digitizers, touch screens and interactive whiteboards. The only requirement is that the operating system on which MindView is installed must also support pen input (e.g. Windows XP Tablet PC Edition, all editions of Windows Vista with the exception of the Home Basic and Starter editions, Windows 7).

Once attached to a branch, the ink data is treated just as any other branch element.



You can use pen input only in the standard Mind Map views, namely Mind Map, Top Down and Left/Right.

### Enabling pen input

Before you can use your mouse or pen as input device, you must enable pen input.

If your computer supports pen input, the MindView Options dialog contains an extra panel for the pen input options.

To access this tab:

- Click the **File** tab.
- Click **MindView Options** in the bottom right.
- Click the panel **Pen Input**.



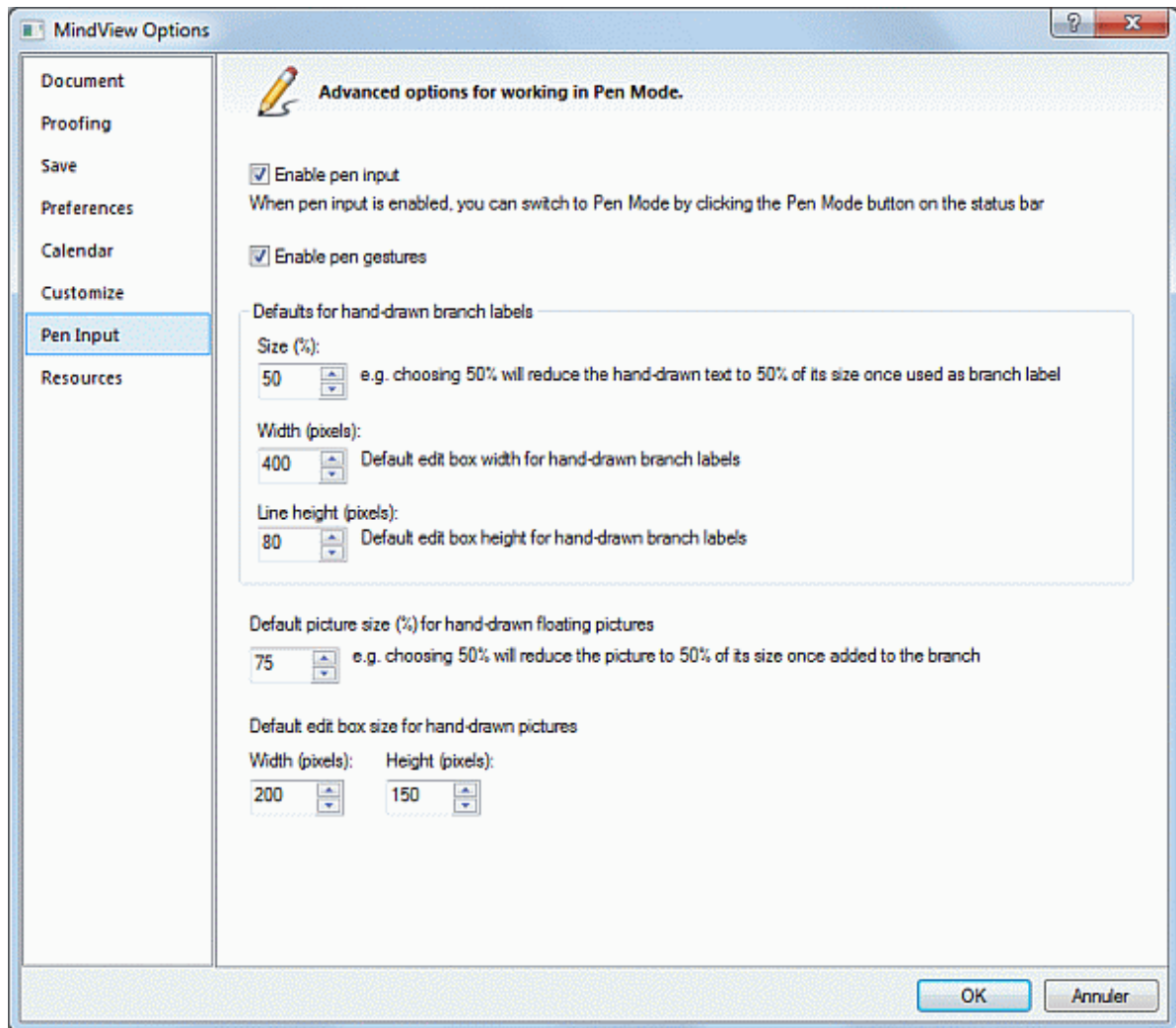

**Enable pen input:** Check this box to enable pen input. When pen input is enabled, a Pen Mode button appears in the bottom right corner of the MindView status bar, allowing you to set Pen Mode on and off.

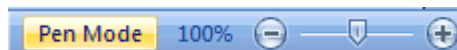

**Enable gestures:** When this option is enabled, you can perform the MindView actions listed in the paragraph "Using gestures" below by making the corresponding gesture with your input device.

**Defaults for hand-drawn branch labels:** When you use your pen to draw text for your branch labels, it is often easier to write using large characters. You can use the **Size (%)** field to define a factor which MindView will automatically use to reduce your hand-drawn text before inserting it on the branch as branch label. Conversely, when you click a hand-drawn branch label to edit it, MindView automatically expands the label if necessary to allow for easier editing. You can use the **Width** and **Line Height** fields to define the initial size of this edit box. If the hand-drawn branch label is wider or taller than the size chosen here, MindView automatically adjusts the size of the edit box to the size of the label.

**Default picture size for hand-drawn floating pictures:** When you use your pen to draw floating pictures, it is often easier to make large drawings. You can use this field to define a factor which MindView will automatically use to reduce your hand-drawn pictures before attaching them to the selected branch.

**Default edit box size for hand-drawn pictures:** When you double-click a hand-drawn picture to edit it, MindView automatically expands it to allow for easier editing. You can use the **Width** and **Height** fields to define the initial size of this edit box. If the hand-drawn picture is wider or taller than the size chosen here, MindView automatically adjusts the size of the edit box to the size of the picture.

## Using Pen Mode

When pen input is enabled, a Pen Mode button is shown in the bottom right corner of the status bar.

- Click it to enable Pen Mode.

The **Ink Tools** tab appears in front of the Home tab on the ribbon.

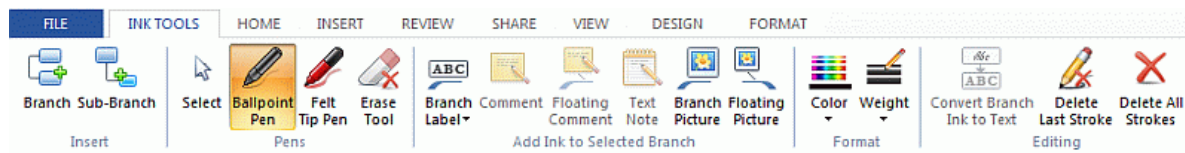

You can now use your input device to start writing or drawing on the free space available in the view (i.e. not on top of a branch, floating comment, floating picture or other MindView element).



- 📌 Before you start writing or drawing, you can use your input device to select the branch to which you want to add the ink data. After your first stroke, you are free to draw anywhere on the workspace, including on top of branches or other MindView elements.

💡 As you start writing or drawing, MindView attempts to interpret the ink data as text and displays the result in the "Ink to Text" field shown just below the ribbon. This lets you correct any misinterpretation by deleting the last stroke or strokes until you obtain the required result. You can also click the down arrow shown at the right of the field to view all the possible interpretations of the ink data and choose the relevant one.

Ink to Text: hello

- 📌 When trying to interpret the ink data, MindView assumes that you are writing in the same language as that defined as your input language in the Windows settings of your computer. If you want your ink data to be interpreted using a different language, set your input language to that language in the Windows Control Panel.

Here is a short description of the tools contained in the **Ink Tools** tab:

- As in the Home and Insert tabs, the **Branch** icon  lets you add a branch at the same level as the selected branch, and the **Sub-Branch** icon  lets you add a sub-branch to the selected branch.
- The **Select** icon in the **Pens** group lets you select and/or move branches with your input device rather than write or draw. The other icons contained in the **Pens** group let you choose the pen to be used to write or draw: **Ballpoint Pen** lets you draw in black thin ink, **Felt Tip Pen** uses a thicker red, and the **Erase Tool** lets you select and delete any of the strokes.

💡 Rather than trying to select the stroke to be deleted, an easier way of using the Erase tool is to drag the mouse across the workspace as you would use a rubber until the pointer hits the stroke. Unlike a rubber however, the Erase tool deletes the entire stroke.

- The icons contained in the **Add Ink to Selected Branch** group let you convert and transfer the ink data to different elements of the map. Some of them are only enabled when you have selected a branch and drawn at least one stroke:

 **Branch Label:** Using this icon, you can choose to convert the ink data to text and use it as branch label for the selected branch (**Branch Label as Text**) or to keep the ink data and use it unchanged as branch label (**Branch Label as Ink**). If you choose to keep the ink data as is, you can convert it to text at any time by selecting the branch and clicking **Convert Branch Ink to Text**.

 **Comment:** Click this icon to convert the ink data to text and add it to the selected branch as pop-up comment.



 **Floating Comment:** Click this icon to convert the ink data to text and add it to the selected branch as floating comment. You can then move the floating comment on the workspace just as you would in standard mouse input mode.

 **Text Note:** Click this icon to convert the ink data to text and add it to the selected branch as text note.

 **Branch Picture:** This icon lets you convert the ink data to a picture (.png) and insert it on the selected branch as branch picture.

 **Floating Picture:** This icon lets you convert the ink data to a picture (.png) and add it to the selected branch as a floating picture. The picture is reduced by a predefined factor, which you can modify in the MindView Options dialog as described above in the paragraph "Enabling pen input". You can then move the floating picture on the workspace just as you would in standard mouse input mode.

 *In large or crowded maps, it is not always easy to find enough free space to draw. If this is the case, it may be easier to click the Branch Picture or Floating Picture icon before starting to draw. This causes MindView to open an edit box on top of the selected branch, in which you can draw freely. When you have finished, just click outside the box. The ink data is then automatically added to the branch.*

- The **Color** and **Weight** icons of the Format group let you redefine respectively the color and the width of the pen.
- To delete the last stroke drawn, click the **Delete Last Stroke** icon .
- The **Delete All Strokes** icon  removes from the workspace all the ink data that has not yet been converted to a MindView.

## Using gestures



As well as using the commands above, you can use pen movements, also called "gestures", to perform particular actions on MindView elements (branches, sub-branches and so on). For this to work, you must enable gestures in the MindView Options dialog, as described above in the paragraph "Enabling pen input".



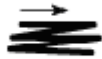

To use a gesture:

- Select the relevant MindView element. For example, if you want to insert a sub-branch select the parent branch; to delete a picture (which may have created by converting a pen tool drawing), select the picture.
- Use the pen tool to draw the gesture.

 Gestures are only recognized when done as a first stroke. They are not available when you are editing ink data.

Here is a list of the gestures you can use:

Gesture	Name	Action	Drawing Method
	Scratch-out	Delete	Draw at least 3 strokes, as horizontal as possible.
	Curlicue	Cut	Draw the curlicue at an angle, from bottom left to top right.
	Double-Curlicue	Copy	Draw the double-curlicue at an angle, from bottom left to top right.

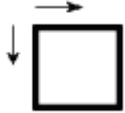
	Caret	Paste	Draw both sides with equal length, with a sharp angle. You can draw in either direction.
	Left-semicircle	Undo	Draw the semicircle from right to left. The two ends should be on the same horizontal line.
	Right-semicircle	Redo	Draw the semicircle from left to right. The two ends should be on the same horizontal line.
	Right	Insert Branch	Draw a single line from left to right.
	Down-right	Insert Sub-Branch	Start with the down stroke, without lifting the pen. Draw the two sides with equal length and at a right angle.
	Square	Insert New Root	Draw the square from the upper left corner, without lifting the pen. You can draw in either direction.

### Using the Tablet PC Input Panel

As well as using your pen to input text into MindView, you can also use the Windows built-in Tablet PC Input Panel. On Microsoft Vista and Windows 7, this panel can also be used to edit existing text.

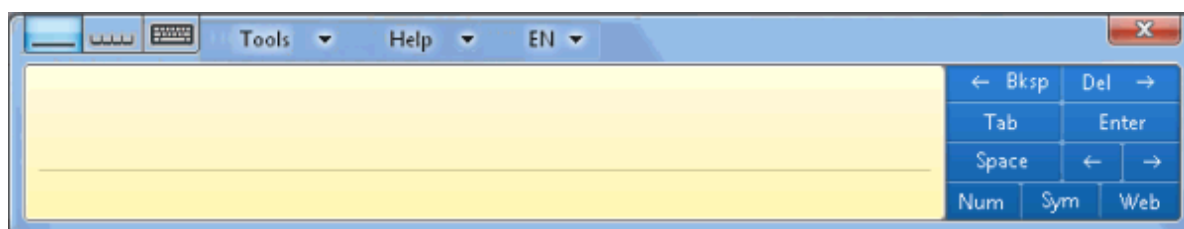

If for instance you use your pen to select a part of a branch label that you want to edit, the text will be shown in the Windows Tablet PC Input Panel. Conversely any change you make to the text shown in the panel is reflected on the branch label.

You can use the same method for text notes, comments and anywhere else in MindView where you can input text, including all edit fields.

### Using an interactive whiteboard

MindView is able to detect and support interactive whiteboards. All the operations described above are supported.

If you are using a SMART Board, MindView automatically switches to Pen Mode when you pick up a pen from the pen tray. In addition, MindView automatically sets its pen color and width to the color and width of the pen you picked up. Picking up the SMART Board eraser automatically selects the Erase Tool in MindView. When no pen has been picked up, a default black color is used.

The pen can also be used to navigate the MindView ribbon and menus in the same way as when using a mouse.

To do a right click, you can press the right click button of the pen tray, use the SMART Board Tools menu, or do a slow click with the pen by pressing it and holding it down for a few seconds.

# Reference

The reference section contains a description of the following MindView features:

- Properties  
These topics give a full description of the properties applicable to each of the MindView elements, such as the view itself, the root, the branches and the various objects.
- Shortcuts  
This topic lists all the keyboard shortcuts provided by MindView.

## Properties

### Overview



The **Properties** dialog shows the properties of the MindView element currently selected, for example the root, a branch or a floating comment. If nothing is selected the properties of the current view are shown.

You can use the Properties dialog to make fine-tuning changes to these elements, as described in "[Using the Properties dialog.](#)"



*Rather than applying properties one by one to enhance the visual aspect of your branches, it is normally easier to use the **Format** tab shown at the right of the ribbon when the branch is selected. Using this tab, you can apply branch shapes, branch colors and other coordinated attributes in one step. Similarly, the **Design** tab lets you apply predefined layouts and styles to the entire map in one step.*

The topics of this section describe in detail the properties shown in the Properties dialog for the various MindView elements.

#### Notes:

- If the Properties dialog is not visible, choose **View | Show/Hide | Properties** to open it.
- The properties described are not always applicable to all views. The Properties dialog only lists the properties applicable to the selected element in the current view.

### View

#### View properties: General tab

When you click the workspace (in other words away from the root or any branch), the following properties are shown in the Properties dialog.

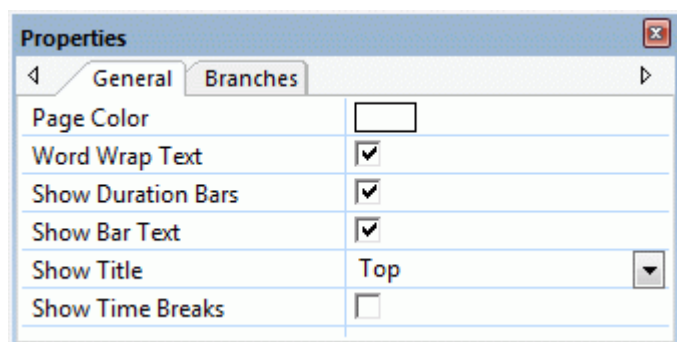

**Page Color:** Click the small rectangle to choose a new color for the workspace.

**Word Wrap Text:** Check this box if you want the text to wrap automatically to the next line when you enter long branch names. This setting applies to all the branches of your document.

**Show Duration Bars:** (Timeline view only) If you have entered both a start time and an end time for a particular event, you can use this property to show the duration of the event as a bar below the time axis.

**Show Bar Text:** (Timeline view only) Check this box to display the label of each branch at the end of the corresponding bar on the timeline. This option is only available for timeline designs showing duration bars under the time axis.

**Show Title:** (Timeline view only) By default, the timeline displays the root name as title, or, if you are focusing on a particular branch, the name of that branch. You can use this property to change the title position or to remove the default title altogether.

**Show Time Breaks:** (Timeline view only) You can use this property to replace any empty space on the time axis with one or more break marks. This optimizes the use of the horizontal space when events are not evenly distributed along the timeline.

**Critical Path Color:** (Gantt view only) Click the small rectangle to choose a different color for the tasks highlighted when viewing the project's critical path (to display the critical path, choose Gantt Tools | View | Show Critical Path).

**Today's Date Color:** (Gantt view only) Click the small rectangle to choose a different color for the vertical line displayed on the Gantt chart to highlight the current date (to display the current date, choose Gantt Tools | View | Show Today's Date).

### View properties: Branches tab

The Branches tab of the View properties dialog allows you to define default properties for the branches of your map.

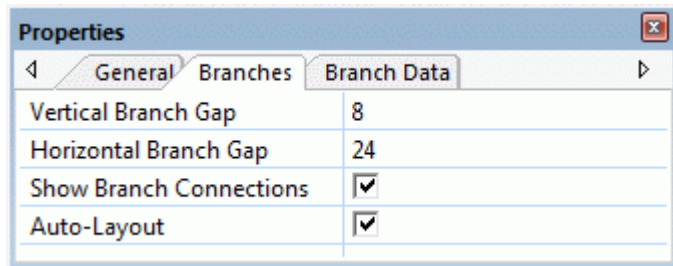

**Vertical Branch Gap:** This value represents the vertical spacing between each set of branches. The default value depends on the view used.

**Horizontal Branch Gap:** This value represents the horizontal spacing between each set of branches. The default value depends on the view used.

**Show Branch Connections:** This box is checked by default. Uncheck it if you do not want branch connections to be visually represented on your map. See "[Creating branch connections](#)" for more information.

**Auto-Layout:** By default, MindView automatically arranges the main branches as you insert them to prevent any overlap. You can however choose to reposition the main branches yourself after their insertion by unchecking this box to disable the auto-layout mode. See "[Moving a branch](#)" for more information.

### View properties: Branch Data tab

The Branch Data tab of the View properties dialog allows you to define the default properties of the branch data shown on the branches of your map.

The branch data is the block of data that may be displayed below particular branch labels on your map (containing for instance task details, timeline information or calculation values).



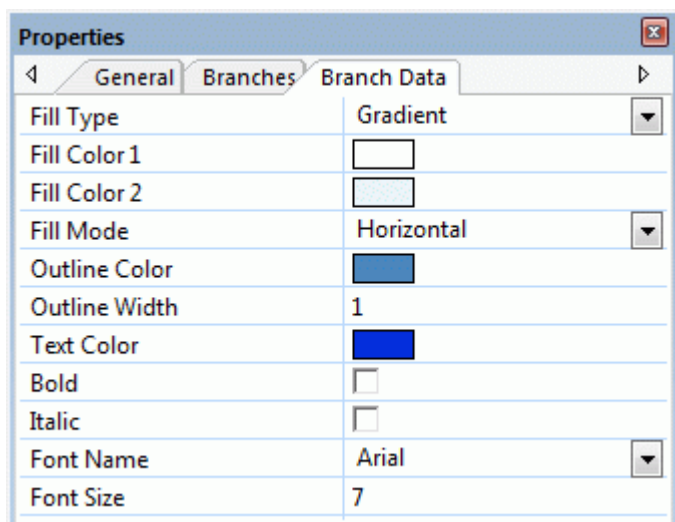

These properties behave in the same way as the properties of the branch itself. For more information, see "[Branch properties: General tab](#)" and "[Branch properties: Text tab](#)".

## Root

### Root properties: General tab

When you select the main root or any other root contained on your map, the following properties are shown in the Properties dialog.

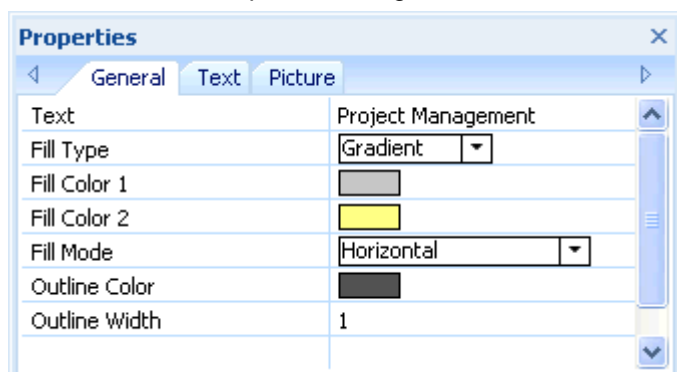

**Text:** This property shows the label of the currently selected root. You can edit it or enter a new label by typing in the input field. If you have split a long label on several lines by pressing **Ctrl + Enter** at the end of each line when creating the branch (rather than let the label wrap automatically), this field will not be editable and will only contain the first line of the label.

**Fill Type:** Choose the fill type required for the space enclosed by the root outline.

**Fill Color 1:** Click the small rectangle to choose a new fill color.

**Fill Color 2:** This property only appears if you have chosen a gradient fill type. It lets you choose the end color for the gradient.

**Fill Mode:** This property only appears if you have chosen a gradient fill type. It lets you choose the direction of the gradient.

**Outline Color:** Click the small rectangle to choose a new outline color.

**Outline Width:** This value defines the width of the outline.

### Root properties: Text tab

The Text tab of the Root properties dialog allows you to define all the properties related to the root label.

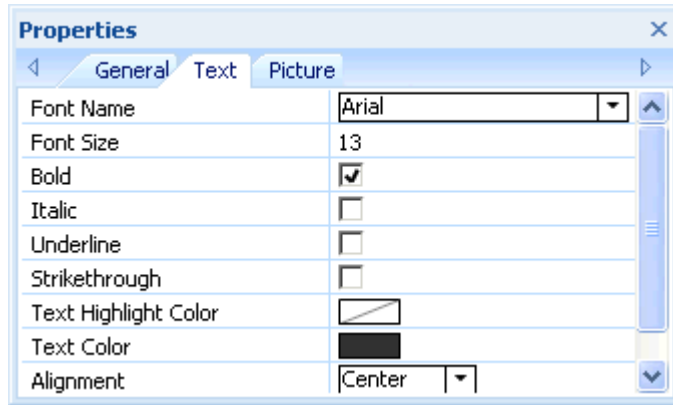

**Font Name:** Click this field to choose a new font for the label.

**Font Size:** Use this field to specify the font size.

**Bold/Italic/Underline/Strikethrough:** Check the relevant box to enable the corresponding effect.

**Text Highlight Color:** Click the small rectangle to choose a new color for the label background.

**Text Color:** Click the small rectangle to choose a new color for the label.

**Alignment:** This property lets you right-align, left-align or center the label within the root shape.

### Root properties: Picture tab

The Properties dialog of the root only contains a Picture tab if you have inserted a branch picture on the root. The Picture tab allows you to define the properties related to the branch picture.

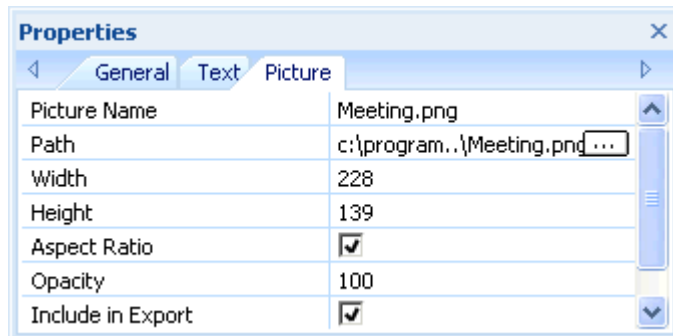

**Picture Name:** By default, this field shows the name of the picture file. You can however replace it with a name of your choice.

- If you export your document to HTML, this picture name will also be inserted in the Alt meta-tag for the picture in the .html file. When viewing the HTML page in the browser and moving the mouse pointer over the picture, you will therefore see the name of the picture appear in a small frame under the picture.
- Similarly, if you export your document to Mediator, the picture name will be inserted in the Notes tab of the Properties dialog of the picture in Mediator.

**Path:** This shows the path of the picture. Enter a new folder and/or file name or click the Browse button  to choose a different picture.

**Width:** This field shows the current width of the picture. You can resize the picture by entering a different value.

**Height:** This field shows the current height of the picture. You can resize the picture by entering a different value.

**Aspect Ratio:** This box is checked by default. Uncheck it if you do not want to preserve the proportions of the picture (in other words, the ratio between its width and its height) when resizing it.

To reset the picture to its initial size, uncheck the box and check it again.

**Opacity:** By default, this field has the value 100, which means that the picture is 100% visible. You can give it a transparency effect by entering a lower value, thereby decreasing its opacity. The value 1 means that the picture is completely transparent.

**Include in Export:** This box is checked by default. Uncheck it if you intend to export your map to another format (HTML, Mediator, Word and so on) but do not want the branch picture to be exported.

## Branch

### Branch properties: General tab

When you select a branch or sub-branch on your map, the following properties are shown in the Properties dialog.

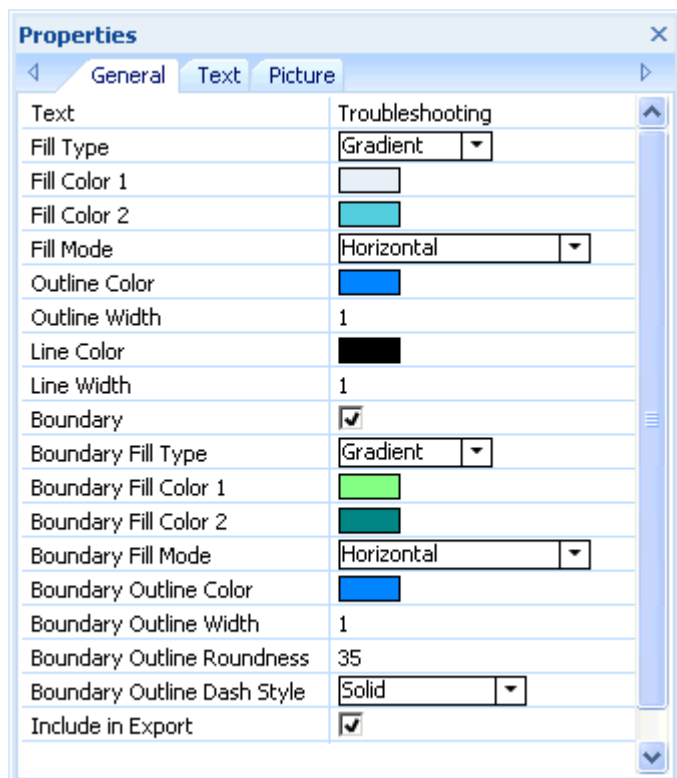

**Text:** This property shows the label of the currently selected branch. You can edit it or enter a new label by typing in the input field. If you have split a long label on several lines by pressing **Ctrl + Enter** at the end of each line when creating the branch (rather than let the label wrap automatically), this field will not be editable and will only contain the first line of the label.

**Fill Type:** Choose the fill type required for the space enclosed by the branch outline.

**Fill Color 1:** Click the small rectangle to choose a new fill color.

**Fill Color 2:** This property only appears if you have chosen a gradient fill type. It lets you choose the end color for the gradient.

**Fill Mode:** This property only appears if you have chosen a gradient fill type. It lets you choose the direction of the gradient.

**Outline Color:** Click the small rectangle to choose a new outline color.

**Outline Width:** This value defines the width of the outline.

**Task Name Color:** (Gantt view only) Click the small rectangle to choose a new color for the task name displayed after the task bar.

**Task Resources Color:** (Gantt view only) Click the small rectangle to choose a new color for the task resources names displayed after the task bar.

**Task Active:** (Gantt projects only) Uncheck this option to make the task inactive, so that it no longer affects the project schedule. See the paragraph "[Making a task inactive](#)" in the topic "[Enhancing a project plan](#)" for more information.

**Bar Hidden:** (Gantt view and Timeline view only) Check this option to hide the bar representing the task or event from the chart or timeline. See the paragraph "[Hiding the bar of a task](#)" in the topic "[Enhancing a project plan](#)" for more information.

**Line Color:** Click the small rectangle to choose new color for the line connecting the branch to its parent branch.

**Line Width:** Enter a value between 1 and 5 to specify the width of the line connecting the branch to its parent branch.

**Boundary:** Check this box to show a boundary around the branch and all its sub-branches.

The next fields only appear if you have checked the Boundary property.

**Boundary Fill Type:** Choose the fill type required for the space enclosed by the boundary.

**Boundary Fill Color 1:** Click the small rectangle to choose a new fill color.

**Boundary Fill Color 2:** This property only appears if you have chosen a gradient fill type. It lets you choose the end color for the gradient.

**Boundary Fill Mode:** This property only appears if you have chosen a gradient fill type. It lets you choose the direction of the gradient.

**Boundary Outline Color:** Click the small rectangle to choose a new color for the boundary outline.

**Boundary Outline Width:** Enter a value between 1 and 5 to define the width of the boundary.

**Boundary Outline Roundness:** Enter a value between 1 and 50 to define how rounded the corners of the boundary should be.

**Boundary Outline Dash Style:** Click the down arrow to choose a style for the boundary.

**Include in Export:** This box is checked by default. Uncheck it if you intend to export your map to another format (HTML, Mediator, Word and so on) but do not want the branch and all its sub-branches to be exported.

### Branch properties: Text tab

The Text tab of the Branch properties dialog allows you to define all the properties related to the branch label.

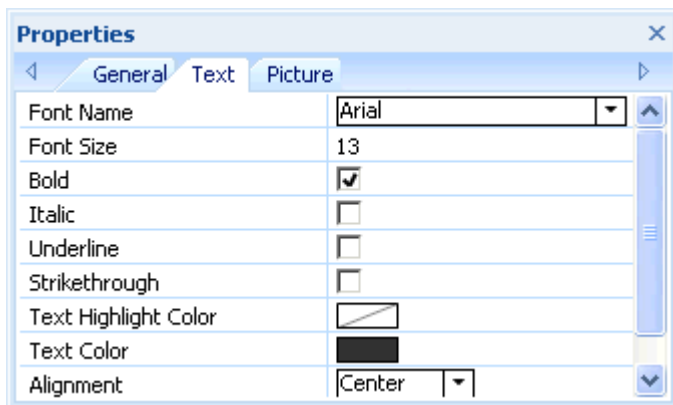

This tab is identical to the Text tab of the root. See "[Root properties: Text tab](#)" for more information.

### Branch properties: Picture tab

The Properties dialog of a particular branch only contains a Picture tab if a branch picture has been inserted on the branch. The Picture tab allows you to define the properties related to the branch picture.

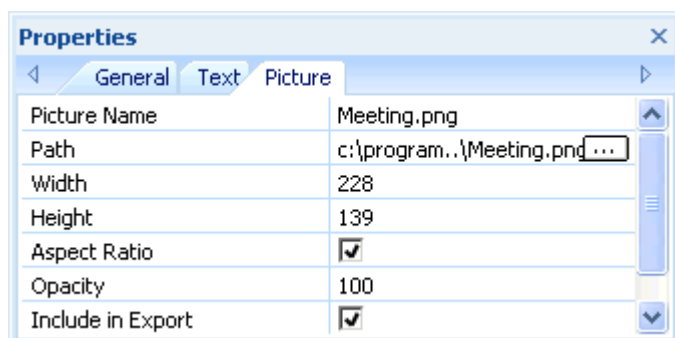

This tab is identical to the Picture tab of the root. See "[Root properties: Picture tab](#)" for more information.

## Branch Data

### Branch data properties: General tab

When you select the block of data displayed below a particular branch label on your map (such as task or timeline information, or again calculation values), the following properties are shown in the Properties dialog.

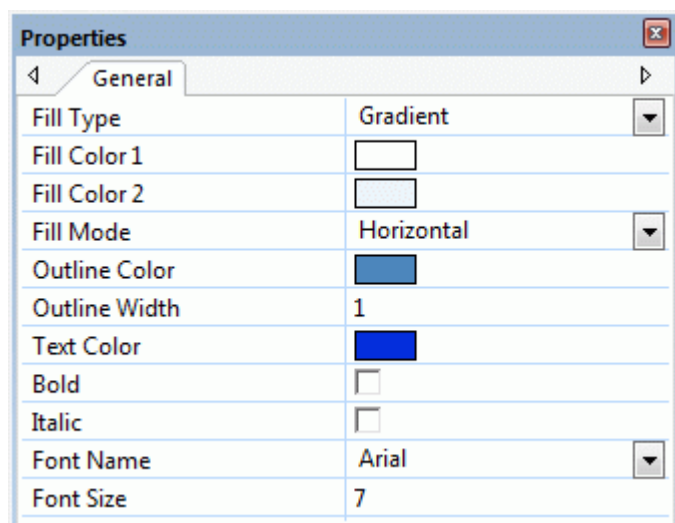

These properties behave in the same way as the properties of the branch itself. For more information, see "[Branch properties: General tab](#)" and "[Branch properties: Text tab](#)".

## Text note

### Text note properties: General tab

When you select a text note in the Object list of a branch, the following properties are shown in the Properties dialog.

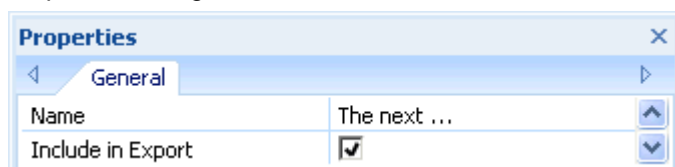

**Name:** This shows the default name of the text note. You can edit it or enter a different name to help you identify the text note.

**Include in Export:** This box is checked by default. Uncheck it if you intend to export your map to another format (HTML, Mediator, Word and so on) but do not want the text note to be exported.

## Floating comment

### Floating comment properties: General tab

When you select a floating comment on the workspace, the following Properties dialog is shown.

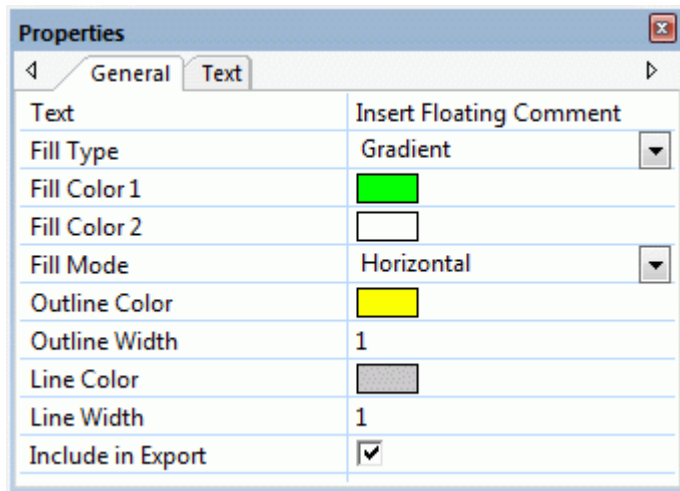

**Text:** This shows the contents of the comment. You can edit it by typing in this field.

**Fill Type:** Choose the fill type required for the space enclosed by the comment outline.

**Fill Color 1:** Click the small rectangle to choose a new fill color.

**Fill Color 2:** This property only appears if you have chosen a gradient fill type. It lets you choose the end color for the gradient.

**Fill Mode:** This property only appears if you have chosen a gradient fill type. It lets you choose the direction of the gradient.

**Outline Color:** Click the small rectangle to choose a new color for the frame surrounding the comment.

**Outline Width:** Edit this field to increase or decrease the width of the frame surrounding the comment.

The next three properties only appear if the floating comment is connected to a branch.

**Line Color:** Click the small rectangle to choose a new color for the line connecting the comment to the branch.

**Line Width:** Edit this field to increase or decrease the width of the line connecting the comment to the branch.

**Include in Export:** This box is checked by default. Uncheck it if you intend to export your map to another format (HTML, Mediator, Word and so on) but do not want the floating comment to be exported.

### Floating comment properties: Text tab

The Text tab of the Floating comment properties dialog allows you to define all the properties related to the comment text.

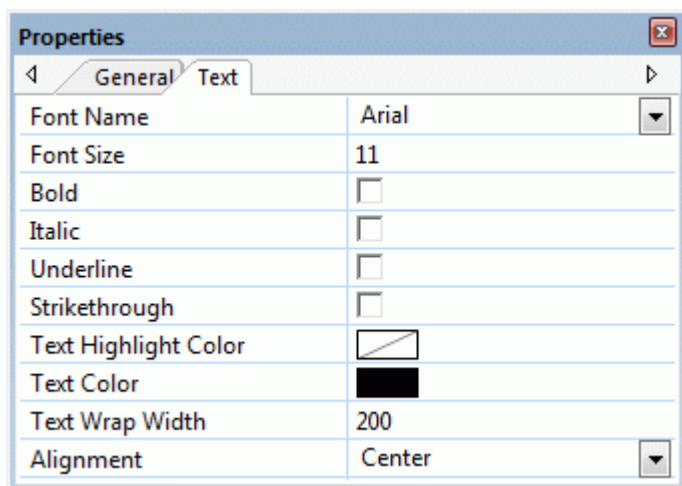

**Font Name:** Click this field to choose a new font for the comment.

**Font Size:** Use this field to specify the font size.

**Bold/Italic/Underline/Strikethrough:** Check the relevant box to enable the corresponding effect.

**Text Highlight Color:** Click the small rectangle to choose a new color for the comment background.

**Text Color:** Click the small rectangle to choose a new color for the comment text.

**Text Wrap Width:** This defines the length of text that can be typed before wrapping onto the next line.

**Alignment:** This property lets you right-align, left-align or center the text of the floating comment within its frame.

## Floating picture

### Floating picture properties: General tab

When you select a floating picture on the workspace, the following properties are shown in the Properties dialog, provided that the floating picture is connected to a branch. If the floating picture is not connected to any branch, the Properties dialog only shows the Picture tab.

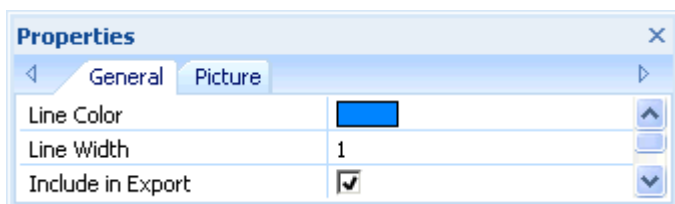

**Line Color:** Click the small rectangle to choose a new color for the line connecting the floating picture to the branch.

**Line Width:** Edit this field to increase or decrease the width of the line connecting the floating picture to the branch.

**Include in Export:** This box is checked by default. Uncheck it if you intend to export your map to another format (HTML, Mediator, Word and so on) but do not want the floating picture to be exported.

### Floating picture properties: Picture tab

Clicking the Picture tab of the Floating picture properties dialog shows the following dialog.



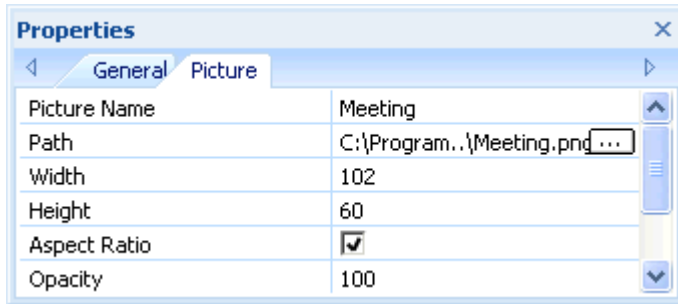

This tab is identical to the Picture tab of the root. See "[Root properties: Picture tab](#)" for more information.

## Attachment

### Attachment properties: General tab

When you select an attachment in the Object list of a branch, the following properties are shown in the Properties dialog.

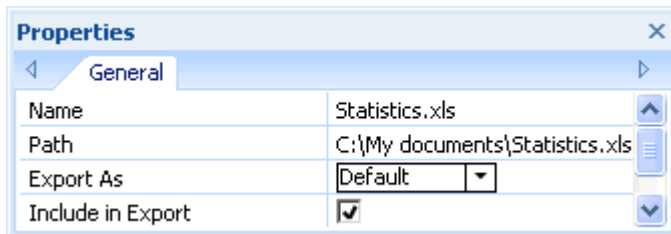

**Name:** By default, this field shows the name of the attached file. You can however replace it with a name of your choice to help you identify the attachment.

If the attachment is a picture file, the name is also used as descriptive label when exporting to HTML or Mediator:

- If you export your document to HTML, this picture name will also be inserted in the Alt meta-tag for the picture in the .html file. When viewing the HTML page in the browser and moving the mouse pointer over the picture, you will therefore see the name of the picture appear in a small frame under the picture.
- If you export your document to Mediator, the picture name will be inserted in the Notes tab of the Properties dialog of the picture in Mediator.

**Path:** This shows the path of the attached file. Enter a new folder and/or file name or click the Browse button  to choose a different file.

**Export As:** By default, the attachment is exported in the format you define during the export procedure for all attachments of this type. This property however gives you the option to export the selected attachment in a different format. If for instance you choose during the HTML export procedure to export all text attachments as buttons, you can override this choice for the selected attachment, and choose instead to export it as a hyperlink.

**Include in Export:** This box is checked by default. Uncheck it if you intend to export your map to another format (HTML, Mediator, Word and so on) but do not want the attached file to be exported.

## Hyperlink

### Hyperlink properties: General tab

When you select a hyperlink in the Object list of a branch, the following properties are shown in the Properties dialog.

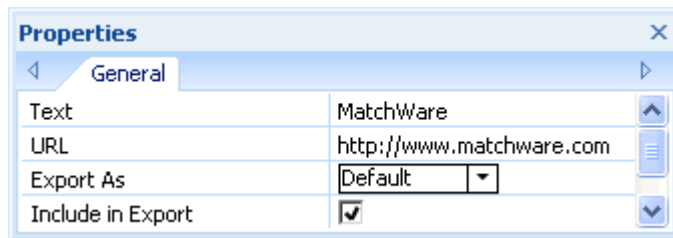

**Text:** By default, this field shows the name of the hyperlink. If you export your map, it is the text that will make up the hyperlink. You can replace it with any other text as required.

**URL:** This shows the URL of the hyperlink. You can edit this field as required or enter a new URL.

**Export As:** By default, hyperlinks are usually exported as hyperlinks. This property gives you the option to override this default export format for the selected hyperlink, and export it instead as a button.

**Include in Export:** This box is checked by default. Uncheck it if you intend to export your map to another format (HTML, Mediator, Word and so on) but do not want the hyperlink to be exported.

## Branch connection

### Branch connection properties: General tab

When you select a branch connection in the Object list of a branch, the following properties are shown in the Properties dialog.

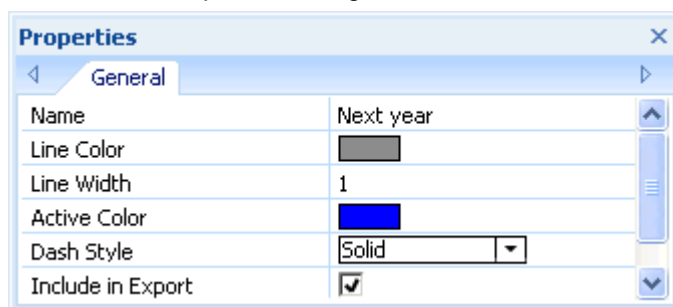

**Name:** This shows the name given to the branch connection, which by default is the name of the end branch.

**Line Color:** This defines the color of the branch connection. Click the small rectangle to choose a new color.

**Line Width:** Edit this field to increase or decrease the width of the branch connection.

**Active Color:** This defines the color of the branch connection when hovered.

**Dash Style:** This field lets you choose between various line styles.

**Include in Export:** This box is checked by default. Uncheck it if you intend to export your map to another format (HTML, Mediator, Word and so on) but do not want the branch connection to be exported.



# Keyboard shortcuts

The table below lists all the keyboard shortcuts provided by MindView.

Keyboard shortcut	Description
<b>Enter</b>	Add a new branch at the same level as the selected branch
<b>Insert</b>	Add a new sub-branch to the selected branch
<b>Shift + Enter</b>	Add a new branch just before the selected branch
<b>Delete</b>	Delete the selected branch or element
<b>Ctrl + Shift + Delete</b>	Delete the selected branch without deleting its sub-branches. The sub-branches become attached to the parent of the deleted branch.
<b>Up</b>	Select the branch placed above the currently selected branch
<b>Down</b>	Select the branch placed below the currently selected branch
<b>Left</b>	Select the branch to the left of the currently selected branch in the map
<b>Right</b>	Select the branch to the right of the currently selected branch in the map
<b>F1</b>	Help
<b>F2</b>	Edit the name of the selected branch or the selected floating comment
<b>F3</b>	Toggle Focus Mode on and off
<b>F4</b>	Resize the map so that it fits entirely in the workspace
<b>F5</b>	Read out aloud the selected branch, comment or text note
<b>F6</b>	Apply branch focus to restrict the display to the selected branch
<b>Ctrl + Shift + F6</b>	Remove branch focus to display the entire map again
<b>F7</b>	Spellcheck the document
<b>Ctrl + F7</b>	Spellcheck the selected element
<b>F8</b>	Toggle between selected branch and Text Note editor
<b>Ctrl + F8</b>	Create a new text note
<b>F9</b>	Toggle Full Screen Mode on and off
<b>F11</b>	Insert or edit a pop-up comment on the selected branch
<b>F12</b>	Specify a start time for the selected branch
<b>Ctrl + F12</b>	Specify an end time for the selected branch
<b>Ctrl + A</b>	Select all branches
<b>Ctrl + F</b>	Find and replace text in document
<b>Ctrl + N</b>	Create a new document
<b>Ctrl + O</b>	Open and browse for an existing document
<b>Ctrl + P</b>	Print the active document
<b>Ctrl + S</b>	Save the active document
<b>Ctrl + Z</b>	Undo the last action
<b>Ctrl + Y</b>	Reverse the last Undo
<b>Ctrl + C</b>	Copy the selected data to the clipboard

<b>Ctrl + X</b>	Cut the selected data to the clipboard
<b>Ctrl + V</b>	Paste the data contained in the clipboard to the selected destination
<b>Ctrl + Shift + C</b>	Copy the formatting from one element to another with the Format Painter
<b>Ctrl + F6</b> <b>Ctrl + Tab</b>	Go from one open document to the next
<b>Ctrl + F8</b>	Open the Text Note editor to create a new text note
<b>Ctrl + Up</b>	Move the selected branch up (Mind Map, Left/Right and Outline views only)
<b>Ctrl + Down</b>	Move the selected branch down (Mind Map, Left/Right and Outline views only)
<b>Ctrl + Left</b>	Move the selected branch left (Top Down view only) Collapses the selected branch (Outline view only)
<b>Ctrl + Right</b>	Move the selected branch right (Top Down view only) Expands the selected branch (Outline view only)
<b>Ctrl + Home</b>	Go to the first cell of the Outline (Outline view, Timeline view, Gantt view)
<b>Ctrl + End</b>	Go to the last cell of the Outline (Outline view, Timeline view, Gantt view)
<b>Ctrl + "+"</b> <b>Alt + mouse wheel</b> <b>Shift + mouse wheel</b>	Zoom in
<b>Ctrl + "-"</b> <b>Alt + mouse wheel</b> <b>Shift + mouse wheel</b>	Zoom out
<b>Ctrl + mouse wheel</b>	Scroll the workspace horizontally
<b>Shift + drag</b>	Navigate the mind map by panning the view within the workspace
<b>Ctrl + 1</b>	Show only the main branches
<b>Ctrl + 2, 3, 4</b>	Show only two, three or four levels of branches
<b>Ctrl + 5</b>	Show all levels of branches
<b>Ctrl + Shift + "+"</b>	Expands the selected branch
<b>Ctrl + Shift + "-"</b>	Collapses the selected branch
<b>Ctrl + Shift + 1</b>	Display the document in Mind Map view
<b>Ctrl + Shift + 2</b>	Display the document in Top Down view
<b>Ctrl + Shift + 3</b>	Display the document in Left/Right view
<b>Ctrl + Shift + 4</b>	Display the document in Timeline view
<b>Ctrl + Shift + 5</b>	Display the document in Outline view
<b>Ctrl + Shift + 6</b>	Display the document in Gantt view
<b>Ctrl + F2</b>	Link tasks (Gantt view only)
<b>Ctrl + Shift + F2</b>	Unlink tasks (Gantt view only)
<b>Shift + F2</b>	Open the Task Information dialog (Gantt view only)
<b>Alt + Shift + Right</b>	Indent the selected branch (Outline view) or task (Gantt view)
<b>Alt + Shift + Left</b>	Outdent the selected branch (Outline view) or task (Gantt view)

# Index

- #NAN.....72
- #NULL!.....72
- .mvdX.....38
- .mvtX.....38
- ABS.....72
- Accelerators.....283
- Access keys.....27
- Activating.....89
  - a branch connection.....94
  - a hyperlink.....92
  - an object.....89
- ACTUALCOST - see also Resources cost .....72, 155
- ACTUALWORK - see also Resources work .....72, 155
- Additional folders..... 110, 187, 209
- Alt picture tag..... 205, 274, 276, 279
- Animation (effect).....32
- Antialiasing.....32
- APA Word template.....188
- Arranging.....119
  - branches.....85
  - objects in the Object list.....119
- As Late As Possible.....169
- As Soon As Possible.....169
- Aspect ratio of a picture..... 274, 276, 279
- Attaching objects.....89
- Attachment - see Object.....89
- AutoCorrect list.....181, 183
- Auto-layout of branches.....85, 272
- Automatic sum.....72
- Auto-recovery feature.....32, 38
- AVG.....72
- Backup files.....38
- Bibliography.....96
  - citations.....101
  - creating.....96
  - exporting.....188
  - sources.....96
- Branch.....41
  - attaching objects.....89
  - auto-layout.....85, 272
  - branch picture.....60
  - citation.....101
  - collapsing.....41
  - copying.....41, 85
  - creating.....41
  - cutting.....41, 85
  - data.....82, 277
  - deleting.....41
  - detaching.....105
  - editing.....41, 82
  - expanding.....41
  - finding text.....103
  - focusing.....40, 87
  - formatting.....45, 82
  - inserting.....41
  - locking.....122
  - moving.....85
  - navigating.....41
  - pastings.....41, 85
  - properties.....117, 271, 272, 275, 276, 277
  - replacing text.....103
  - selecting several.....82
  - shape.....45, 82
  - showing/hiding.....41, 87, 88
  - spellchecking.....181
  - word wrapping.....271
- Branch connection.....94
  - activating.....94
  - creating.....94
  - curve.....94
  - deleting.....94
  - properties.....117, 281
  - showing/hiding.....272
  - start and end branch.....94
- Branch label.....41
  - narrating.....41
- Branch picture.....60
  - deleting.....60

detaching .....	60	Finish No Later Than.....	169
dragging.....	60	Must Finish On .....	169
inserting .....	60	Must Start On .....	169
properties.....	117, 274, 276	Start No Earlier Than .....	169
replacing .....	60	Start No Later Than.....	169
Bulleted lists .....	51	Conversion from older versions .....	40
Buttons navigation.....	209, 233	Copying a branch.....	41, 85
in HTML export .....	209	from an external application .....	41
in Mediator export.....	233	from MindView.....	41, 85
Calculation panel.....	72	COST - see also Resources cost .....	72, 155
Calculation value .....	72	COUNT .....	72
constants .....	72	Creating .....	36
default.....	72	a branch .....	41
display order .....	72	a branch connection.....	94
format.....	72	a branch picture.....	60
inserting .....	72	a calculation value.....	72
showing/hiding.....	72	a citation .....	101
Calendar.....	148	a filter.....	88
default.....	148	a floating comment.....	56
project.....	148	a floating picture .....	60
resources .....	148, 155	a formula .....	72
Changes.....	106	a hyperlink.....	92
Checking a mind map .....	109	a legend.....	107
Citation .....	101	a Mediator document .....	229
adding.....	101	a mind map.....	36, 105
deleting .....	101	a new root.....	105
editing .....	101	a PDF document .....	228
exporting .....	188	a pop-up comment .....	56
inserting .....	101	a PowerPoint presentation .....	192
sources .....	96	a project plan.....	65, 141, 147
Clipart.....	60, 112	a report .....	178
Collapsing.....	41	a resource list .....	155
a branch.....	41	a RTF document.....	245
a mind map.....	41, 47	a source.....	96
Color dialog .....	117	a spreadsheet.....	197
Comment (floating) - see Floating comment.	56	a task list .....	65
Comment (pop-up) - see Pop-up comment ..	56	a text note.....	51
Compacting a mind map .....	45	a timeline .....	68, 131
Completion level.....	65, 172	a web site .....	205
Compressing a mind map .....	110	a Word document.....	188
Constants .....	72	an attachment.....	89
Constraints .....	169, 175	an Excel spreadsheet.....	197
As Late As Possible.....	169	an outline.....	137
As Soon As Possible .....	169	Critical path.....	172, 175
Finish No Earlier Than.....	169	filtering.....	175



showing/hiding.....	172, 175	Dictionaries .....	181
total slack.....	175	AutoCorrect list.....	181, 183
Currency options.....	155	custom.....	181, 183
Custom dictionaries.....	181, 183	language.....	181
Custom icons - see Icons.....	59	standard .....	181
Custom Style Designer .....	45	Distributing a mind map .....	110
Customizing .....	27, 141	Docking panels .....	27, 32
map styles .....	45	Document - see Mind map.....	36
the Gantt chart.....	141, 172	Document properties.....	32, 271, 272
your preferences.....	32	Dragging a picture.....	60
your workspace .....	27	Duration .....	65, 68, 131, 141, 152
Cutting a branch.....	85	of a task.....	65, 141, 152
Daily timescale .....	68	of an event.....	68, 131
Data files .....	109	Duration bars .....	131, 141
Dates.....	65, 68, 131, 141	in the Gantt view.....	141, 152
in a project plan .....	65, 141, 148, 152	in the Timeline view.....	131
in a task list.....	65	Editing .....	41
in a timeline .....	68, 131	a branch .....	41, 82
Deadline .....	169, 172	a citation .....	101
Default calendar .....	148	a floating comment.....	56
Default value .....	72	a hyperlink.....	92
Deleting .....	41	a pop-up comment .....	56
a branch.....	41	a root .....	41, 82
a branch connection .....	94	a source.....	96
a branch picture.....	60	a task.....	152
a branch section .....	41	a text note.....	51
a citation .....	101	EFFECT .....	72
a filter.....	88	Effort-driven scheduling .....	155
a floating comment .....	56	End times definitions.....	68, 131
a floating picture .....	60	Entering and editing tasks .....	152
a hyperlink .....	92	Excel - see Microsoft Excel.....	197, 257
a pop-up comment.....	56	Expanding .....	41
a source.....	96	a branch .....	41
a template.....	38	a mind map.....	41, 47
a text note.....	51	Exporting.....	187
an attachment.....	89	a calendar.....	148
an icon .....	59	a project plan.....	179
Dependencies - see Relationships .....	164	a resources list .....	155
Designing a mind map .....	45	a task list .....	125, 201
Desktop search .....	103	as picture.....	249
Detaching.....	56, 60, 105	Export Wizard.....	187, 209, 233
a branch.....	105	FTP Upload Manager .....	225
a branch picture.....	60	overview .....	187
a floating comment .....	56	packing .....	110
a floating picture .....	60	Quick Export.....	187, 207, 230

to HTML.....	205, 207, 209	detaching.....	60
to MatchWare Mediator .....	229, 230, 233	dragging .....	60
to Microsoft Excel .....	197	inserting.....	60
to Microsoft Outlook.....	201	properties .....	117, 279
to Microsoft PowerPoint.....	192	replacing.....	60
to Microsoft Project.....	204	Focus mode .....	47
to Microsoft Word .....	188	Focusing on a branch .....	40, 87
to PDF.....	228	Folder structure.....	110, 187, 209
to RTF.....	245	Format Painter .....	82
to XML .....	248	Formatting.....	82
FAQ Knowledge Base.....	17	a branch .....	82
Filter .....	88	a comment.....	56
applying .....	88	a root or branch label .....	82
clearing .....	88	a text note.....	51
defining .....	88	Formula.....	72
deleting .....	88	FreeMind.....	264
Filtering a Gantt chart.....	175	FTP Upload Manager .....	225
Filtering a mind map.....	40, 88	Full Screen mode.....	49
Finding and replacing text.....	103	Functions .....	72
in branch names .....	103	ABS .....	72
in floating comments.....	103	ACTUALCOST .....	72, 155
in object names .....	103	ACTUALWORK.....	72, 155
in pop-up comments .....	103	AVG.....	72
in text notes .....	103	COST .....	72, 155
Finish No Earlier Than .....	169	COUNT.....	72
Finish No Later Than.....	169	EFFECT .....	72
Finish to Finish.....	164	FV.....	72
Finish to Start.....	164	INT.....	72
Fixed Duration task .....	161	LN.....	72
Fixed Units task.....	161	LOG.....	72
Fixed Work task .....	161	MAX.....	72
Floating comment.....	56	MIN.....	72
creating.....	56	NOMINAL .....	72
deleting .....	56	POWER.....	72
detaching .....	56	PV.....	72
editing .....	56	REMAININGCOST .....	72, 155
finding text .....	103	REMAININGWORK.....	72, 155
formatting.....	56	SQRT .....	72
inserting .....	56	SUM .....	72
narrating .....	47, 56	WORK .....	72, 155
properties.....	117, 278	FV.....	72
replacing text .....	103	Gantt chart .....	141
spellchecking .....	181	customizing .....	141
Floating picture.....	60	filtering.....	175
deleting .....	60	reports .....	178

timescale .....	141	Ink data .....	265
viewing.....	141	Inserting .....	41
Gantt Tools tab.....	141	attachments.....	89
Gantt view .....	141	branch connections .....	94
Geological timescale .....	68	branch pictures.....	60
Gestures.....	265	branches.....	41
Help .....	17	calculation values.....	72
Hiding a task .....	141, 172	citations .....	101
Hiding/Showing - see Showing/Hiding .....	41	floating comments .....	56
Historic timescale .....	68	floating pictures .....	60
HTML.....	205	formulas.....	72
exporting.....	205, 207, 209	hyperlinks .....	92
Hyperlink .....	51, 92	icons .....	59
activating .....	92	main branches.....	41
copying .....	92	pop-up comments.....	56
creating.....	92	pre-branches .....	41
deleting.....	92	sounds.....	91
editing.....	92	sub-branches.....	41
in text notes .....	51	task data.....	65, 141
moving .....	92	text notes.....	51
properties.....	117, 280	timeline information .....	68, 131
Icons.....	59	values .....	72
deleting .....	59	Installation.....	15
inserting .....	59	INT .....	72
replacing.....	59	Interactive whiteboard.....	265
img folder.....	205	Keyboard shortcuts.....	283
Importing .....	251	Lag time .....	164
a calendar .....	148	Language .....	181
a resources list .....	155	changing the dictionary .....	181
a task list.....	125, 259	Layouts .....	45
from FreeMind .....	40, 263, 264	Lead time .....	164
from MatchWare Mediator .....	261	Learning Management System - see LMS ..	209
from Microsoft Excel.....	257	Left/Right view .....	130
from Microsoft Outlook .....	259	Legend .....	107
from Microsoft PowerPoint .....	253	Level List navigation .....	209, 233
from Microsoft Project.....	261	in HTML export.....	209
from Microsoft Word .....	251	in Mediator export.....	233
from MindManager .....	40, 263, 264	Linking tasks .....	164
from XML .....	263	LMS system .....	209
overview .....	251	LN.....	72
Inactivating a task .....	141, 172	Locking.....	122
Include in export.....	187	a branch .....	122
Indicators.....	141	a document.....	122
constraints .....	169	LOG .....	72
deadlines .....	172	Main branch - see Branch.....	41

Map - see Mind map .....	36	sources.....	96
Map navigation.....	47	Milestone.....	172
MatchWare Mediator.....	229, 261	MIN.....	72
exporting.....	229, 230, 233	Mind map .....	36
importing.....	261	bibliography.....	96
MatchWare Shared Workspace .....	120	citations.....	101
access rights.....	120, 122	collapsing.....	41, 47
accessing.....	120	compacting.....	45
account.....	120	compressing.....	110
branch locking.....	122	converting.....	40
closing documents.....	120	creating.....	36
collaborating.....	122	data files.....	109
connecting.....	120	designing.....	45
document locking.....	122	distributing.....	110, 111
managing.....	120	expanding.....	41, 47
opening documents.....	120	exporting.....	187
owner.....	120	filtering.....	40, 47, 88
saving documents.....	120	focusing.....	47, 87
shared documents.....	120	importing.....	251
shared folders.....	120	layouts.....	45
Material resources - see Resources .....	155	legend.....	107
MAX.....	72	locking.....	122
Mediator - see MatchWare Mediator...229, 261		merging.....	110
Merging mind maps.....	110	navigating.....	47
Microsoft Excel.....	197, 257	numbering scheme.....	47
exporting.....	197	online.....	120
importing.....	257	opening.....	40
Microsoft Outlook .....	201, 259	owner.....	120
exporting.....	201	packing.....	110
importing.....	259	password.....	106
synchronizing.....	201, 259	presenting.....	47, 108
Microsoft PowerPoint .....	192, 253	printing.....	79
exporting.....	192	properties.....	45, 117, 271, 272
importing.....	253	protecting.....	106
Microsoft Project .....	204, 261	root.....	41
exporting.....	204, 248	saving.....	38
importing.....	261, 263	scrolling.....	47
Microsoft SharePoint.....	120	sending.....	111
Microsoft Word .....	188, 251	sharing.....	122
APA template.....	188	showing task info.....	65
bibliography.....	96	showing timeline info.....	68
citations.....	96, 101	sources.....	96
exporting.....	188	spellchecking.....	181
importing.....	251	statistics.....	47
MLA template .....	188	styles.....	45

- tracking changes .....106
- unpacking .....110
- viewing.....47
- zooming .....49
- Mind Map view .....128
- MindManager .....40
  - importing a .mmap file .....264
  - importing an .xml file.....263
  - opening a .mmap file .....40
- MLA Word template .....188
- mmap MindManager file..... 40, 263, 264
- Moving a branch.....85
  - auto-layout.....85, 272
- Multimedia Catalog .....60, 112
  - adding elements .....112
  - browsing .....112
  - connecting a category .....112
  - keywords .....112
  - overview .....112
  - resetting.....32, 112
  - searching .....112
- Must Finish On .....169
- Must Start On .....169
- mvfiles folder .....205
- MVHtmlExport folder .....205
- MVPPImport folder .....253
- Narrating.....41, 47
- Navigating a mind map .....47
  - expanding/collapsing.....47
  - filtering .....47, 88
  - focusing .....47, 87
  - panning.....47
  - scrolling.....47
  - zooming .....47, 49
- Navigation pins.....47
- NOMINAL .....72
- Note - see Text note.....51
- Notes tab (Mediator Properties dialog) .....
  - 229, 261, 274, 276, 279
- Number format .....72
- Numbered lists .....51
- Numbering scheme ..... 47, 137, 141, 188
- Object.....89
  - activating .....89
  - attaching .....89
  - copying .....89
  - deleting.....89
  - moving.....89
  - properties .....117, 280
- Object list .....119
  - using.....119
- Object name.....280
  - finding text.....103
  - replacing text.....103
  - spellchecking.....181
- Online workspace .....120
  - accessing .....120
  - closing documents.....120
  - managing.....120
  - opening documents.....120
  - saving documents .....120
- Opacity of a picture.....274, 276, 279
- Opening .....40
  - a Mediator file.....261
  - a Microsoft PowerPoint file.....253
  - a Microsoft Project file.....261, 263
  - a Microsoft Word file .....251
  - a mind map.....40
  - a MindManager file.....40, 263
  - an Excel spreadsheet.....257
  - an XML file .....263
- Other icons - see Icons.....59
- Outline view .....137
- Outlook - see Microsoft Outlook .....201, 259
- Overview panel .....118
- Packing a mind map .....110
- Page properties.....45, 271, 272
- Panels .....27
  - Calculation.....72
  - Changes .....106
  - docking/undocking.....27, 32
  - Legend .....107
  - Multimedia .....112
  - Object List .....119
  - Overview .....118
  - Properties .....117
  - resetting.....27, 32
  - resizing .....27, 32
  - showing/hiding.....27, 32
  - Task panel.....65, 141

Text Note editor .....	51	Project - see Microsoft Project.....	204, 261
Time(line) Info panel.....	68, 131	Project calendar .....	148
Timeline Outline.....	131	Project management.....	141
Panning a mind map .....	47	Project plan .....	141
Password.....	106	calendar.....	148
Pasting a branch .....	41, 85	creating.....	65, 141, 147
into an external application.....	41	critical path .....	172, 175
into MindView .....	41, 85	deadlines .....	169, 172
PDF .....	228	end date .....	148, 175
Pen input .....	265	enhancing.....	172
Pen Mode.....	265	exporting.....	178, 201, 204, 248
Picture .....	60	global settings .....	148
aspect ratio .....	274, 276, 279	importing.....	259, 261, 263
branch pictures .....	60, 274, 276	milestones .....	172
dragging.....	60	printing.....	180
exporting .....	249	reports .....	178
floating pictures .....	60, 279	resources.....	155
inserting .....	60	reviewing .....	175
moving .....	60	scheduling mode .....	148
Multimedia Catalog.....	112	setting up.....	147
name.....	274, 276, 279	start date .....	148, 175
opacity .....	274, 276, 279	task dates .....	152
picture objects .....	89, 280	tasks .....	152
Pins .....	47	viewing .....	141
Pop-up comment.....	56	Properties.....	117, 271
creating.....	56	attachment.....	280
deleting .....	56	branch .....	271, 272, 275, 276
editing .....	56	branch connection .....	281
finding text .....	103	branch data .....	272, 277
inserting .....	56	branch picture.....	274, 276
narrating .....	47, 56	document.....	271, 272
replacing text .....	103	floating comment.....	278
resizing .....	56	floating picture .....	279
spellchecking .....	181	hyperlink .....	280
POWER.....	72	mind map.....	271, 272
PowerPoint - see Microsoft PowerPoint.....		object.....	280
192, 253		page .....	271
Pre-branch - see Branch .....	41	root .....	273, 274
Predecessors .....	164	text note.....	277
Preferences .....	32	view .....	271, 272
Presenting a mind map .....	47, 108	workspace .....	271, 272
Preview.....	32	Properties dialog .....	117
Printing a mind map .....	79	PV .....	72
Priority .....	65, 172	Quick Access Toolbar .....	27
Problems (reporting) .....	17	customizing .....	27, 32

- resetting .....27
- Quick Data.....72
- Quick Start.....18
- Quotation - see Citation .....101
- Rate - see also Resources.....155
- Recognizer .....265
- Relationships.....164
  - Finish to Finish .....164
  - Finish to Start .....164
  - Start to Finish .....164
  - Start to Start .....164
- REMAININGCOST - see also Resources
  - cost .....72, 155
- REMAININGWORK - see also Resources
  - work .....72, 155
- Replacing .....59, 60
  - a branch picture .....60
  - a floating picture .....60
  - an icon .....59
- Replacing text .....103
  - in branch names .....103
  - in floating comments.....103
  - in object names .....103
  - in pop-up comments .....103
  - in text notes .....103
- Reporting a problem.....17
- Reports.....178
- Resetting .....27, 32
  - the default calendar .....148
  - the Multimedia Catalog.....32, 112
  - the project calendar .....148
  - the workspace .....27, 32
- Resources .....65, 155
  - accountability .....178
  - calendars .....148, 155
  - cost .....141, 155
  - global list.....155
  - material .....155
  - rate.....155
  - showing/hiding.....141
  - task distribution.....125, 201
  - type .....155
  - units .....155
  - work .....141, 155
  - workload .....178
- Restoring - see Resetting .....27, 32
- Root .....36, 41
  - creating.....36, 105
  - editing.....41, 82
  - formatting .....45, 82
  - properties .....273, 274
  - shape.....45, 82
- RTF .....245
- Saving a mind map .....38
- Scheduling .....148, 155, 161
  - effort-driven .....155
  - mode .....148
  - options.....155, 161
  - task type .....161
- SCORM package .....209
- Scrolling a mind map .....47
- Searching and replacing text .....103
  - in branch names.....103
  - in floating comments .....103
  - in object names .....103
  - in pop-up comments.....103
  - in text notes.....103
- Searching the desktop .....103
- Selecting several branches.....82
- Sending a mind map .....111
- Serial number.....32
- Service Packs .....17
- Setting up.....27
  - a project plan.....147
  - your preferences .....32
  - your workspace .....27
- Shared workspace - see MatchWare Shared Workspace .....120
- SharePoint .....120
- Sharing documents - see Microsoft Shared Workspace .....120
- Shortcut keys .....27, 283
- Showing/Hiding .....41
  - branch connections .....272
  - branches.....41, 87, 88
  - calculation values .....72
  - critical path .....141, 172
  - current date .....141
  - panels.....27
  - resources.....141



task bar .....	172	Synchronizing .....	201
task data .....	65	with Microsoft Outlook .....	201, 259
task name .....	141	Tables .....	51
text notes .....	137	Tablet PC .....	265
timeline information .....	68, 131	Task .....	65, 141
Slack .....	175	bar .....	141, 152, 172
SMART board .....	265	color .....	141
Sound .....	91	completion .....	65, 172
copying .....	91	constraint .....	169, 175
deleting .....	91	cost .....	155
inserting .....	91	creating .....	65, 152
moving .....	91	customizing .....	141
playing .....	91	dates .....	65, 141, 152
properties .....	91, 117, 280	deadline .....	169, 172
Sources .....	96	dependency .....	164
adding .....	96	distributing .....	125, 155, 201
deleting .....	96	duration .....	65, 141, 152
editing .....	96	effort-driven .....	155
exporting .....	188	exporting .....	125, 155, 201
Spellchecker .....	181, 183	filtering .....	175
options .....	183	Fixed Duration .....	161
usage .....	181	Fixed Units .....	161
Spellchecking .....	181	Fixed Work .....	161
branch names .....	181	hiding .....	172
entire mind map .....	181	importing .....	125, 201
floating comments .....	181	inactivating .....	141, 172
object names .....	181	lag time .....	164
pop-up comments .....	181	lead time .....	164
text notes .....	181	linking .....	164
Spreadsheet .....	197, 257	managing .....	125
SQRT .....	72	milestone .....	172
Standard task - see Task .....	65, 152	notes .....	172
Standard timescale .....	68	pattern .....	141
Start No Earlier Than .....	169	predecessors .....	164
Start No Later Than .....	169	priority .....	65, 172
Start to Finish .....	164	relationship .....	164
Start to Start .....	164	resources .....	65, 155
Statistics .....	47	scheduling type .....	161
Styles .....	45	shape .....	141
Sub-branch - see Branch .....	41	successors .....	164
Subject of the mind map .....	41	summary .....	152
Successors .....	164	synchronizing .....	201
SUM .....	72	total slack .....	175
Summary task .....	141, 152	units .....	155
Support .....	17	unlinking .....	164

work .....	155	duration bars .....	131, 271
Task data.....	65	expanding.....	131
entering.....	65, 141	exporting to HTML.....	131, 209
formatting.....	65	filtering.....	131
showing/hiding.....	65	focusing.....	131
Task management .....	65	inserting time breaks .....	131, 271
Task name.....	141	numbering scheme.....	131
showing/hiding.....	141	printing.....	131
Task panel.....	65, 141	timescale .....	68
using .....	65, 141	title .....	131, 271
Templates.....	36	viewing .....	131
academic use .....	36	zooming.....	131
business use.....	36	Timeline data .....	68, 131
customized .....	38	entering .....	68, 131
export.....	188, 192, 197, 209, 233	formatting .....	68
personal use .....	36	showing/hiding.....	68
saving .....	38	Timeline Outline panel .....	131
using .....	36	using.....	131
Terminology .....	12	Timeline view .....	68, 131
Text .....	103	Timescale - Gantt chart .....	141
finding .....	103	Timescales - Timelines .....	68
replacing .....	103	Daily .....	68
Text note .....	51	Geological .....	68
citations.....	101	Historic .....	68
creating.....	51	Standard.....	68
default font.....	32	Weekly.....	68
deleting .....	51	Today's date.....	141
editing .....	51	showing/hiding.....	141
finding text .....	103	Top Down view .....	128
inserting .....	51	Total slack.....	175
narrating .....	47, 51	Touch screen .....	265
properties.....	277	Tracking changes.....	106
quotations .....	101	Tree List navigation.....	209
replacing text .....	103	in HTML export.....	209
spellchecking.....	181	Troubleshooting .....	17, 32
Text Note editor.....	51	Undo feature .....	32
using .....	51	Undocking panels .....	27
Time breaks .....	131	Units - see also Resources.....	155
Time(line) panel .....	68, 131	Unlinking tasks.....	164
using .....	68, 131	Unpacking a mind map .....	110
Timeline.....	68, 131	Updates (program).....	32
compressing .....	131	Value - see Calculation value .....	72
creating.....	131	View .....	45, 127
dates.....	68, 271	designing.....	45
designing .....	131	properties .....	45, 271, 272

Viewing area .....	47, 118	Word - see Microsoft Word .....	188, 251
Views.....	127	Word wrapping.....	271
Gantt view.....	141	WORK - see also Resources work .....	72, 155
Left/Right view .....	130	Work resources - see Resources .....	155
Mind Map view.....	128	Workspace .....	27
Outline view .....	137	properties .....	45, 271, 272
Timeline view.....	131	setting up.....	27
Top Down view .....	128	WorldCat .....	96
Web site .....	205	XML.....	248, 263
Weekly timescale .....	68	exporting.....	248
Welcome dialog.....	32, 36	importing.....	263
Whiteboard .....	265	Zooming in and out .....	49